

GJ1118

0.8A Low Dropout Positive Adjustable or Fixed-Mode Regulator

Description

The GJ1118 is a low dropout at positive adjustable or fixed-mode regulator with minimum of 0.8A output current capability. The product is specifically designed to provide well-regulated supply for low voltage IC applications such as high-speed bus termination and low current 3.3V logic supply. GJ1118 is also well suited for other applications such as VGA cards. GJ1118 is guaranteed to have lower than 1.3V dropout at full load current making it ideal to provide well regulated outputs of 1.25V to 5.0V with up to 12V input supply.

Features

- 1.4V maximum dropout full load current
- Fast transient response
- Output current limiting
- Built-in thermal shutdown
- Good noise rejection
- 3-Terminal Adjustable or Fixed 1.5V,1.8V,2.5V,3.3V,5.0V

Applications

- PC peripheral
- Communication

Package Dimensions

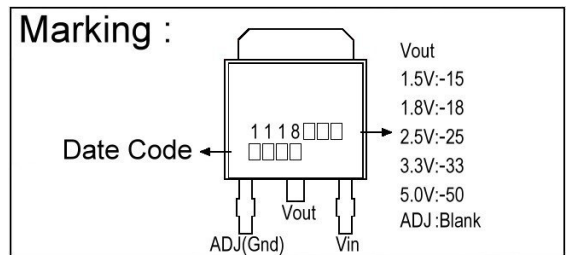
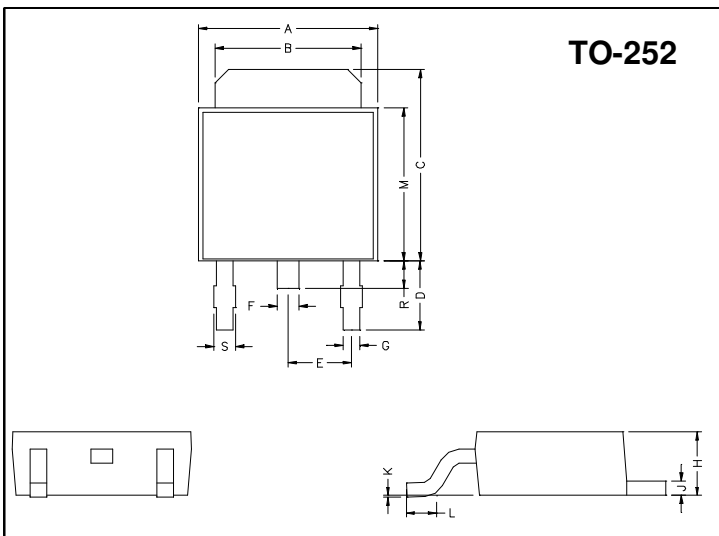

REF.	Millimeter		REF.	Millimeter	
	Min.	Max.		Min.	Max.
A	6.40	6.80	G	0.50	0.70
B	5.20	5.50	H	2.20	2.40
C	6.80	7.20	J	0.45	0.55
D	2.40	3.00	K	0	0.15
E	2.30 REF.		L	0.90	1.50
F	0.70	0.90	M	5.40	5.80
S	0.60	0.90	R	0.80	1.20

Typical Circuit

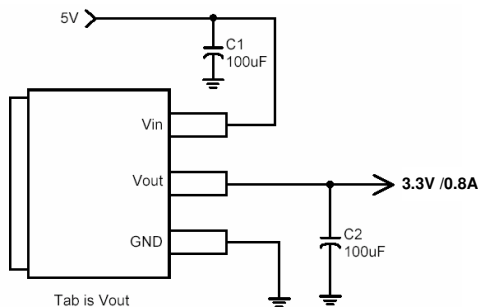

(5V/3.3V fixed output)

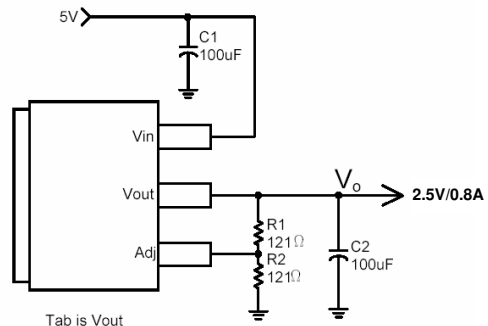

(5V/2.5V ADJ output)

Note: $V_o = V_{REF} * (1 + \frac{R_2}{R_1})$

Block Diagram

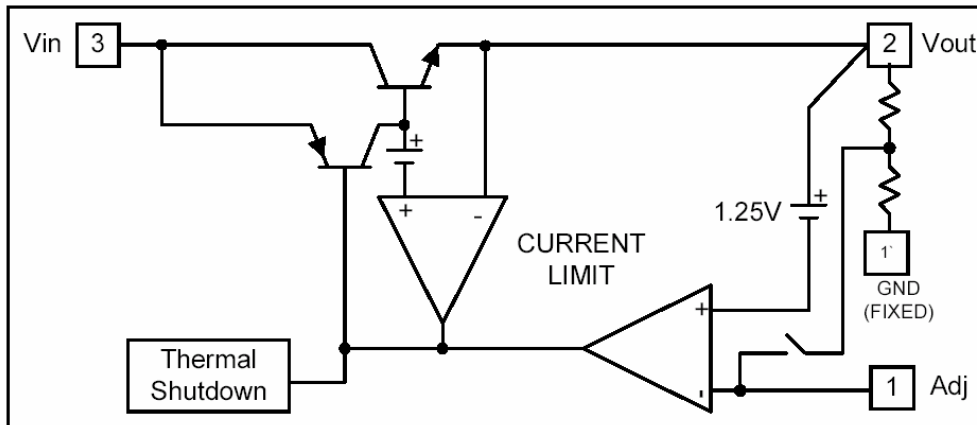

Pin Descriptions

Name	I/O	Pin#	Function
Adj (GND)		1	A resistor divider from this pin to the Vout pin and ground sets the output voltage (Ground only for fixed mode)
Vout	O	2	The output of the regulator. A minimum of 10uF capacitor ($0.15\Omega \leq \text{ESR} \leq 20\Omega$) must be connected from this pin to ground to insure stability.
Vin	I	3	The input pin of regulator. Typically a large storage capacitor ($0.15\Omega \leq \text{ESR} \leq 20\Omega$) is connected from this pin to ground to insure that the input voltage does not sag below the minimum dropout voltage during the load transient response. This pin must always be 1.3V higher than Vout in order for the device to regulate properly.

Absolute Maximum Ratings

Symbol	Parameter	Ratings	Unit
VIN	DC Supply Voltage	-0.3 to 12	V
PD	Power Dissipation	Internally Limited	
TST	Storage Temperature	-65 ~ + 150	°C
TOP	Operating Junction Temperature Range	0 ~ + 150	°C

Electrical Characteristics

Parameter	Conditions		Min	Typ	Max	Unit
Reference Voltage	GJ1118ADJ	$I_o=10\text{mA}$, $T_J=25^\circ\text{C}$, $(V_{IN}-V_{OUT})=1.5\text{V}$	1.225	1.250	1.275	V
Output Voltage	GJ1118-1.5	$I_o=10\text{mA}$, $T_J=25^\circ\text{C}$, $3.0\text{V}\leq V_{IN}\leq 12\text{V}$	1.470	1.500	1.530	V
	GJ1118-1.8	$I_o=10\text{mA}$, $T_J=25^\circ\text{C}$, $3.3\text{V}\leq V_{IN}\leq 12\text{V}$	1.764	1.800	1.836	V
	GJ1118-2.5	$I_o=10\text{mA}$, $T_J=25^\circ\text{C}$, $4.0\text{V}\leq V_{IN}\leq 12\text{V}$	2.450	2.500	2.550	V
	GJ1118-3.3	$I_o=10\text{mA}$, $T_J=25^\circ\text{C}$, $4.8\text{V}\leq V_{IN}\leq 12\text{V}$	3.235	3.300	3.365	V
	GJ1118-5.0	$I_o=10\text{mA}$, $T_J=25^\circ\text{C}$, $6.5\text{V}\leq V_{IN}\leq 12\text{V}$	4.900	5.000	5.100	V
Line Regulation	GJ1118-XXX	$I_o=10\text{mA}$, $V_{OUT}+1.5\text{V}< V_{IN}< 12\text{V}$, $T_J=25^\circ\text{C}$	-	-	0.2	%
Load Regulation	GJ1118ADJ	$V_{IN}=3.3\text{V}$, $V_{adj}=0$, $0\text{mA}< I_o< 0.8\text{A}$, $T_J=25^\circ\text{C}$ (Note 1,2)	-	-	1	%
	GJ1118-1.5	$V_{IN}=3.0\text{V}$, $0\text{mA}< I_o< 0.8\text{A}$, $T_J=25^\circ\text{C}$ (Note 1,2)	-	12	15	mV
	GJ1118-1.8	$V_{IN}=3.3\text{V}$, $0\text{mA}< I_o< 0.8\text{A}$, $T_J=25^\circ\text{C}$ (Note 1,2)	-	15	18	mV
	GJ1118-2.5	$V_{IN}=4.0\text{V}$, $0\text{mA}< I_o< 0.8\text{A}$, $T_J=25^\circ\text{C}$ (Note 1,2)	-	20	25	mV
	GJ1118-3.3	$V_{IN}=5.0\text{V}$, $0\text{mA}< I_o< 0.8\text{A}$, $T_J=25^\circ\text{C}$ (Note 1,2)	-	26	33	mV
	GJ1118-5.0	$V_{IN}=8.0\text{V}$, $0\text{mA}< I_o< 0.8\text{A}$, $T_J=25^\circ\text{C}$ (Note 1,2)	-	40	50	mV
Dropout Voltage ($V_{IN}-V_{OUT}$)	GJ1118-XXX	$I_o=0.8\text{A}$ ($\Delta V_{OUT}=0.1\% V_{OUT}$)	-	1.2	1.4	V
Current Limit	GJ1118-XXX	$V_{IN}-V_{OUT}=5\text{V}$	0.9	-	-	A
Minimum Load Current	Adjustable model	$V_{in}=5\text{V}$	-	5	10	mA
Adjust Pin Current	Adjustable model	$V_{in}=12\text{V}$, $I_o=10\text{mA}$	-	50	100	μA
Quiescent Current	fixed model	$V_{in}=12\text{V}$, $I_o=0\text{mA}$	-	-	12	mA
Thermal Regulation	$T_A=25^\circ\text{C}$, 30ms pulse		-	0.008	0.04	%/W
Ripple Rejection	$F=120\text{Hz}$, $C_{OUT}=25\mu\text{F}$ Tantalum, $I_{OUT}=0.8\text{A}$					
	GJ1118-XXX	$V_{IN}=V_{OUT}+3\text{V}$	-	60	70	dB
Temperature Stability	$I_o=10\text{mA}$		-	0.5	-	%
θ_{JA} Thermal Resistance Junction-to-Ambient(No heat sink ;No air flow)			-	92	-	$^\circ\text{C}/\text{W}$
θ_{JC} Thermal Resistance Junction-to-Case	Control Circuitry/Power Transistor		-	10	-	$^\circ\text{C}/\text{W}$

Note 1: See thermal regulation specifications for changes in output voltage due to heating effects. Line and load regulation are measured at a constant junction temperature by low duty cycle pulse testing. Load regulation is measured at the output lead =1/18" from the package.

Note 2: Line and load regulation are guaranteed up to the maximum power dissipation of 15W. Power dissipation is determined by the difference between input and output and the output current. Guaranteed maximum power dissipation will not be available over the full input/output range.

Characteristics Curve

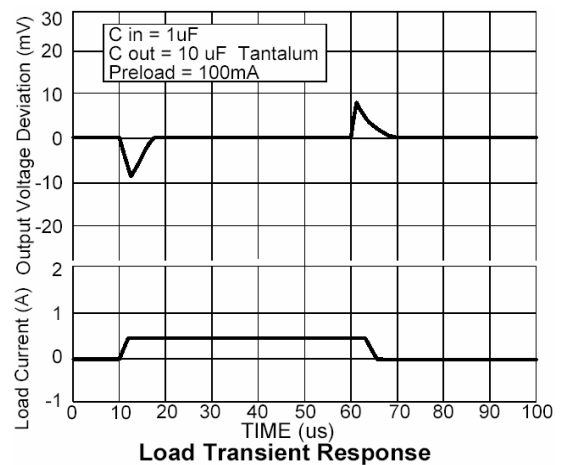
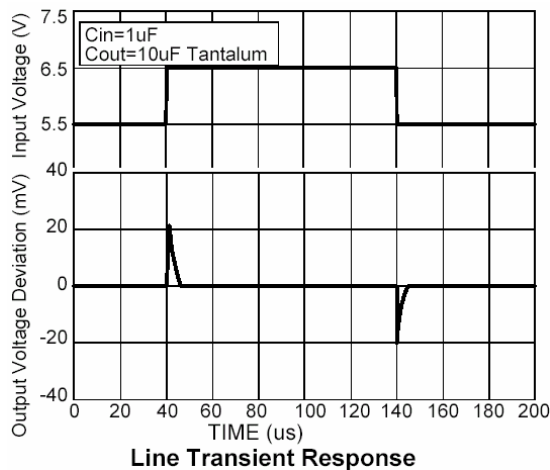
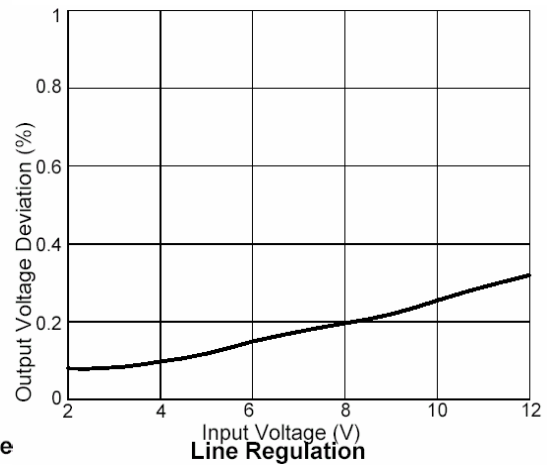
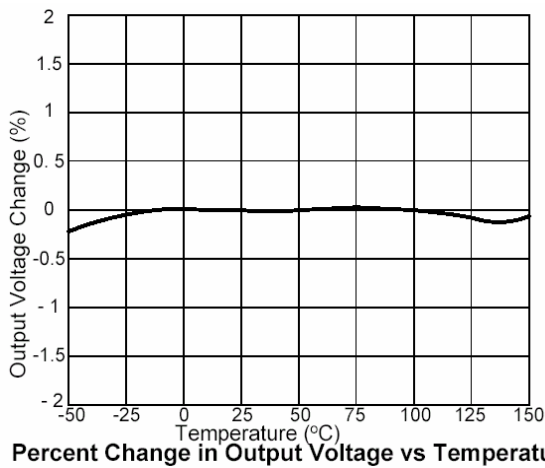
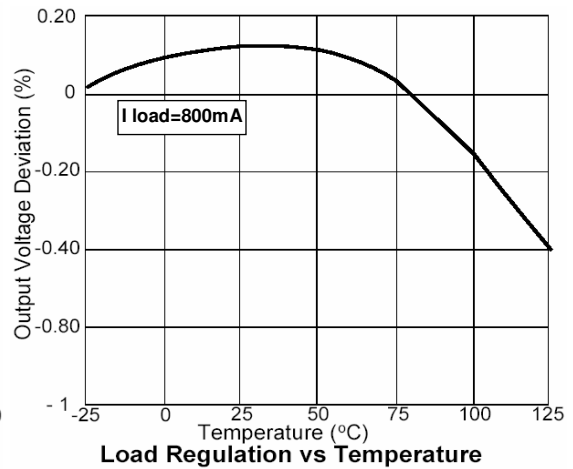
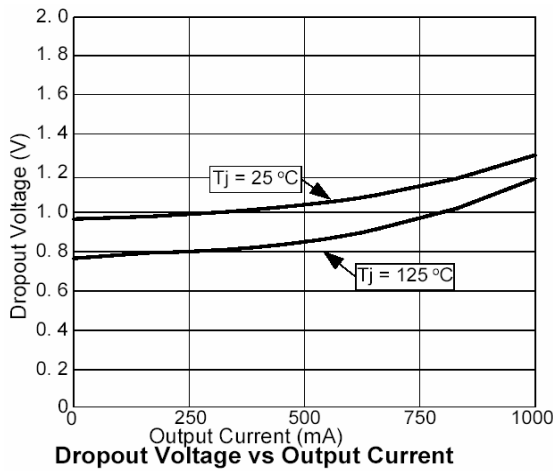

Important Notice:

- All rights are reserved. Reproduction in whole or in part is prohibited without the prior written approval of GTM.
- GTM reserves the right to make changes to its products without notice.
- GTM semiconductor products are not warranted to be suitable for use in life-support Applications, or systems.
- GTM assumes no liability for any consequence of customer product design, infringement of patents, or application assistance.

Head Office And Factory:

- Taiwan:** No. 17-1 Tatung Rd. Fu Kou Hsin-Chu Industrial Park, Hsin-Chu, Taiwan, R. O. C.
- TEL : 886-3-597-7061 FAX : 886-3-597-9220, 597-0785
- China:** (201203) No.255, Jang-Jiang Tsai-Lueng RD. , Pu-Dung-Hsin District, Shang-Hai City, China
- TEL : 86-21-5895-7671 ~ 4 FAX : 86-21-38950165