

SERIES 94H
Binary Coded

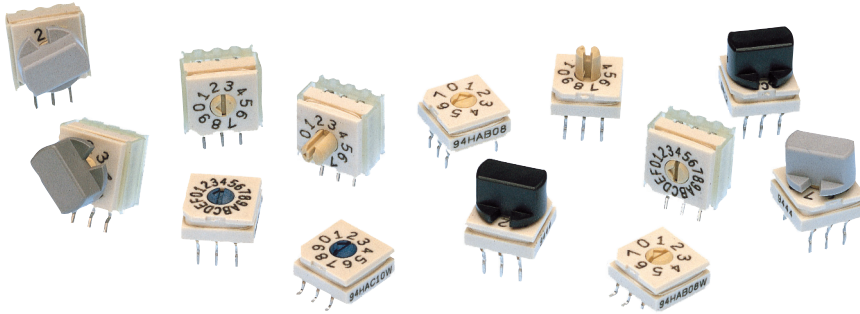

FEATURES

- Sealed Construction; No Tape Seal Required
- Surface Mount or Thru-Hole Style
- Tube or Tape and Reel Packaging
- Octal, BCD, and Hexadecimal Code
- In Standard or Complement
- Standard and Right Angle Mount
- Flush or Extended Actuators
- Gold-Plated Contacts

DIMENSIONS In inches (and millimeters)

Tolerances are ± .010 inches unless specified otherwise.

Surface Mount Gullwing

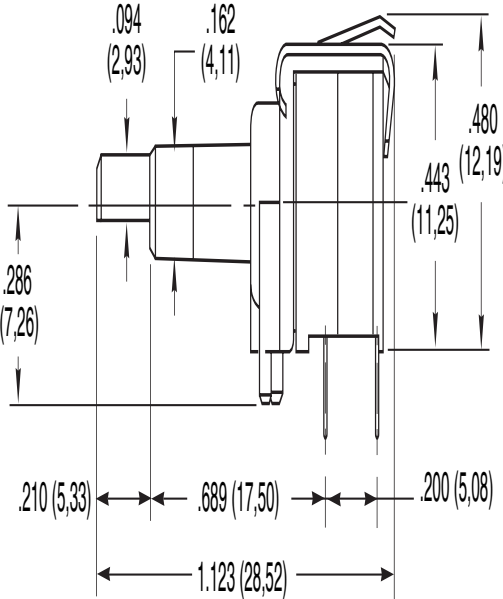
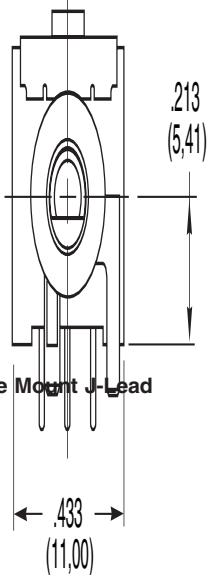

Standard Thru-Hole

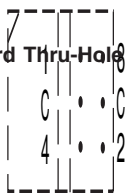

PC board layout as viewed from the top of the switch

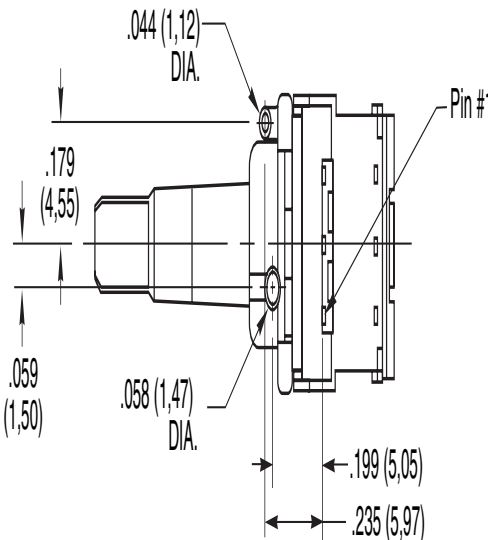

ACTUATOR STYLES



Octal-8 position



BCD-10 position



Hex-16 position



Figure 1
"A" style rotor

Figure 2
"F" style rotor

All actuation types are available in octal (8), binary coded decimal (10), or hexadecimal (16) codes; with either standard or complement output. Standard code outputs have natural color rotors; complements in a contrasting color.

EXTENDED ACTUATOR TYPES

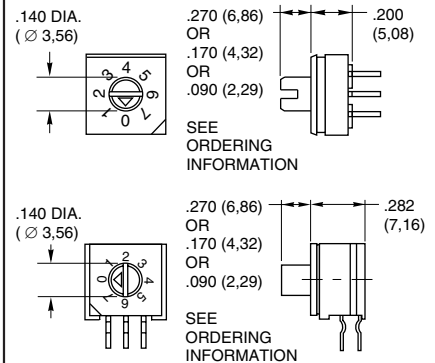
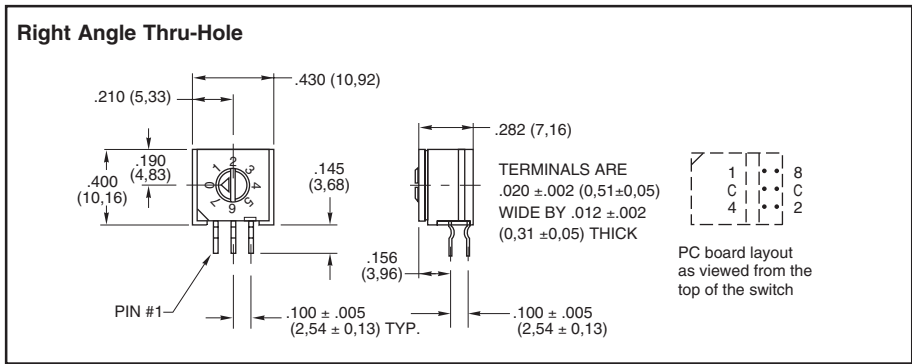

Figure 3

DIMENSIONS In inches (and millimeters)



ORDERING INFORMATION: Series 94H

94HAB10WRT

Series
Actuator Style: A = Flush, Figure 1
B = .270, Figure 3 (see page B-21)
C = .170, Figure 3 (see page B-21)
E = .090, Figure 3 (see page B-21)
F = Flush, Figure 2

Code: B = Standard (Natural),
C = Complementary (Contrasting Color)

RoHS Compliant

Packaging: R = Tape and Reel, (Surface Mount Only)
Blank = Tube*

Terminal Style: RA = Right Angle, Thru-Hole
J = J-Lead
W = Surface Mount
Blank = Thru-Hole

Number of Positions: 08 = Octal, 8 Position
10 = BCD, 10 Position
16 = Hex, 16 Position

* 27 Pieces per tube for surface mount and thru-hole, 24 pieces per tube for right angle switches.

SERIES 94 High Temperature Knobs: For Shaft Extensions

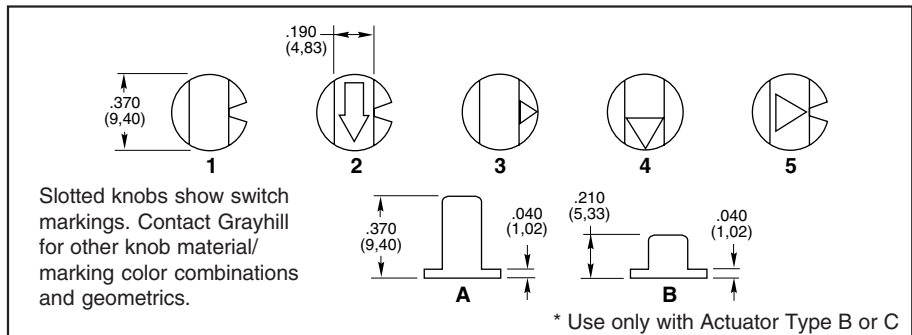

ORDERING INFORMATION: Series 94 High Temperature Knobs*

Knob Style and Height	Knob Color	Arrow Color	Part Number
1A	Gray	N/A	947706-001
5A	Gray	Black	947706-005
1B	Black	N/A	947705-001
1B	Gray	N/A	947705-012
2B	Gray	White	947705-004
3B	Gray	Black	947705-017
4B	Gray	Black	947705-018
1B	Natural	N/A	947705-009
4B	Black	White	947705-010
5B	Gray	Black	947705-019

*Ordered as a separate item. B = Standard (Natural), C = Complementary (Contrasting Color).

TAPE AND REEL PACKAGING: Series 94H

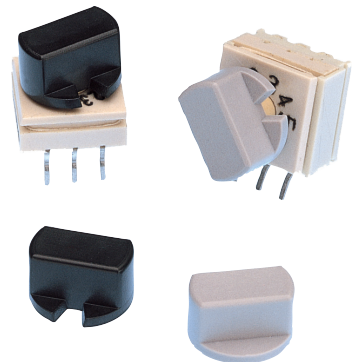
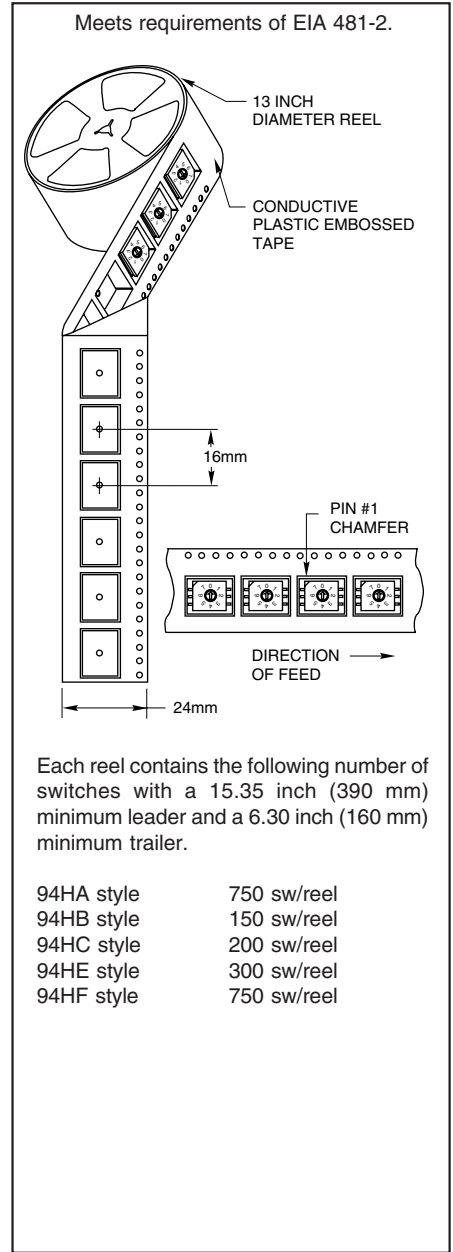

Available from your local Grayhill Distributor. For prices and discounts, contact a local Sales Office, an authorized local Distributor or Grayhill.

SERIES 94R

Economical, Binary Coded

FEATURES

- 10,000 Cycles of Operation
- Gold-Plated Contacts
- Sealed Contact System
- Right Angle Mount
- Octal, BCD & Hexadecimal Codes
- Standard or Complement
- RoHS Compliant

DIMENSIONS In inches (and millimeters)

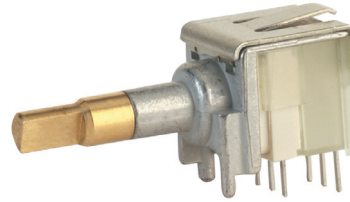
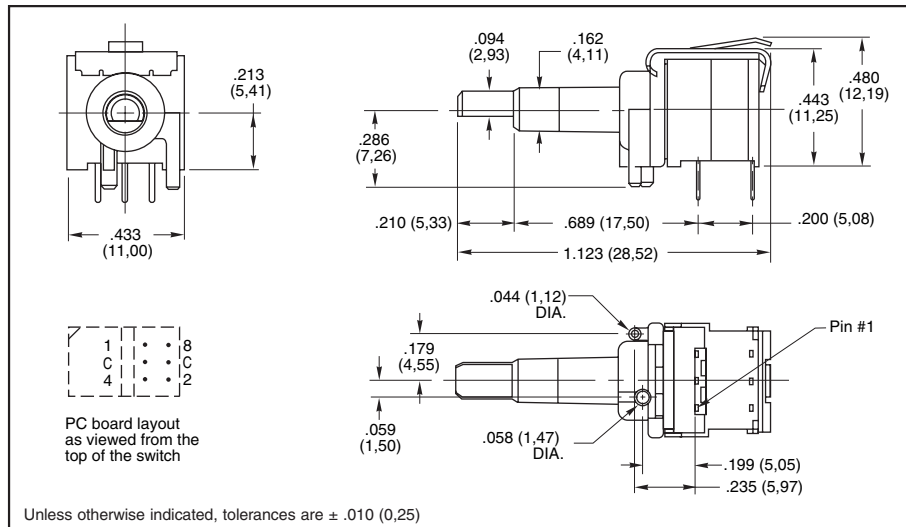

CODE & TRUTH TABLES: Series 94H and 94R

Standard Output	CODE OUTPUT				CODE OUTPUT				Complement Output
	1	2	4	8	1	2	4	8	
0					•	•	•	•	
1	•								•
2		•							•
3	•	•							•
4			•						•
5	•			•					•
6		•			•				•
7	•	•							•
8			•						•
A	•								•
B		•							•
C	•	•							•
D			•						•
E	•			•					•
F		•			•				•

Dot indicates terminal to common connection. All switches are continuous rotation.

Octal and Octal Complement outputs are 0 thru 7 positions.

BCD and BCD Complement outputs are 0 thru 9 positions.

Hexadecimal and Hexadecimal Complement outputs are 0 thru F positions.

Standard codes have natural color rotors; complements have rotors in a contrasting color.

Internal O-ring: Rubber BUNA-N

Soldering Information

Soldering Temperature: 260° C maximum.

Cleaning: Acceptable solutions include 1-1-1 Trichlorethane, Freon (TF, TE, or TMS), Isopropyl Alcohol and detergent (140°F maximum). Solutions which are not recommended include Acetone, Methylene Chloride, and Freon TMC.

SPECIFICATIONS: Series 94H and 94R

Electrical Ratings

Make-and-break Current Rating: 30 mA at 30 Vdc for 10,000 cycles of operation.

Carrying Current Rating: 100 mA at 50 Vdc

Contact Resistance: 50 mohms maximum initially (measured at 10 mA, 50 mVdc). 150 mohms maximum after life.

Insulation Resistance:(measured at 100 Vdc across open switch contacts) Initial: 5000 Mohms minimum. After Life: 1000 Mohms minimum.

Dielectric Strength: (measured across open switch contacts) Initial: 500 Vac RMS minimum. After Life: 250 Vac RMS

Mechanical Ratings

Mechanical Life: 10,000 cycles of operation. One cycle is a rotation through all positions and a complete return through all positions.

Mechanical Shock: 1000g's, 0.5 mS, half sine per MIL-STD-202F, Method 213, Test Condition E.

Vibration Resistance: 10-2000 Hz at 15G or 0.060" double amplitude per MIL-STD-202F, Method 204, Test Condition B.

Operational Torque: 2 to 6 inch-ounces initially and 1.2 inch-ounces minimum after life.

Environmental Ratings

Operating Temperature Range: -40° to +85°C.
Storage Temperature Range: -40° to +85°C.

Moisture Resistance: 240 hours with temperature cycling and polarization. Passes insulation resistance and dielectric strength per MIL-STD-202F, Method 106 following exposure.

Materials and Finishes

Rotor and Switch Body: Plastic (UL94V-O)

Contact Material: Copper alloy plated. 30 microinches minimum gold over 50 microinches minimum nickel.

Shorting Member: Copper alloy plated. 30 microinches minimum gold over 50 microinches minimum nickel.

Terminals: Copper alloy, matte tin plated over nickel barrier.

ORDERING INFORMATION: Series 94R

Continuous Rotation Versions			
Code	No. of Positions	Standard Code Part Number	Complement Part Number
Octal	8	94RB08CT	94RC08CT
BCD	10	94RB10CT	94RC10CT
Hexadecimal	16	94RB16CT	94RC16CT
Rotational Stop Versions*			
Code	No. of Positions	Standard Code Part Number	Complement Part Number
Hexadecimal	16	94RB16FT	94RC16FT

* Consult Grayhill for 8 or 10 position

OPTIONS

Position Identification Line Option

For Series 76RSB, 76RSC, 76RSD, & 90B
 A line can be added to the recessed rocker or Series 90 slide actuator to provide positive identification of the actuator position. To order, add L as a final suffix to the part number. For example, 76RSB08 becomes 76RSB08L; and, 90B08S becomes 90B08SL.
Available from a local Grayhill Distributor.

Other Switch Markings

For Series 76, 78, & 90
 We can mark your part number or other wording on the switch, often at no charge. For some markings there will be a nominal charge for tooling plus a set-up charge. In addition, there is a marking charge per side per switch. Add it to the unit price and discount it accordingly.
To order, contact Grayhill.

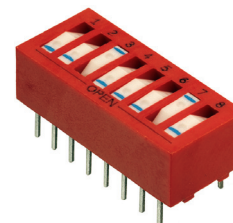

ACCESSORIES

Protective Cover Accessory

For Series 76, & 78

Rigid, clear plastic cover fits all but toggle actuated switches. It provides a top cover for less strenuous cleaning, serves as a dust cover in dirty environments, and provides protection against accidental actuation.

Material: 76,78, only-Polycarbonate.
 Purchase as a separate item. Check length of the desired DIP Switch, and then select from the ordering information on this page.
Available from a local Grayhill Distributor.

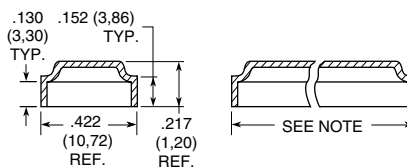

Note: For length, add .042 "(1,07 MM) to length of DIP switch.

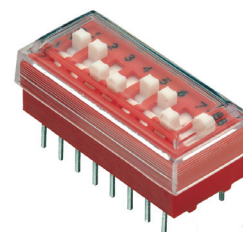

DIPSTICK Accessory

For all series

Pen-sized plastic DIPSTICK has a tapered end for actuating DIP Switches.

Part Number **90-DIPSTICK**

Available from a local Grayhill Distributor



ORDERING INFORMATION

Length Inches	Protective Cover Part Number
0.280	76P02
0.380	76P03
0.480	76P04
0.580	76P05
0.680	76P06
0.780	76P07
0.880	76P08
0.980	76P09
1.080	76P10
1.180	79P10
1.780	79P16

Available from your local Grayhill Distributor.
 For prices and discounts, contact a local Sales Office, an authorized local Distributor or Grayhill.

DIP Switches