

# AC10DGM to AC10FGM

## 10 A MOLD TRIAC

### PACKAGE DIMENSIONS (Unit: mm)

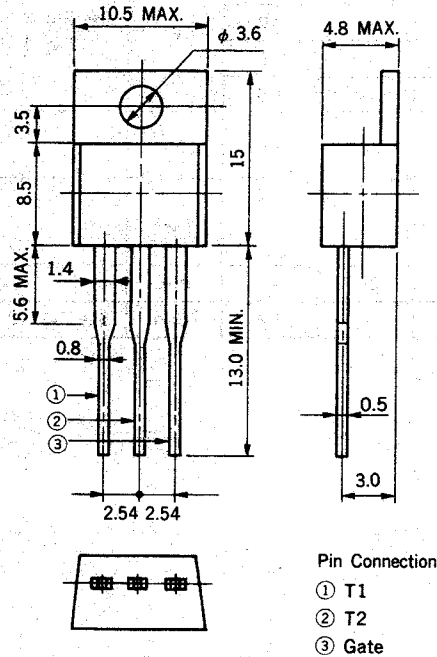

The AC10DGM to AC10FGM are all diffused mold type triac granted RMS On-state current 10 Amps, with rated voltages up to 600 volts.

### FEATURES

- 80 A Surge Current
- TO-220AB mold package
- Low-cost

### APPLICATIONS

- Motor speed control
- Lamp dimmer, Temperature controllers
- Various solid state switches, etc.

### MAXIMUM RATINGS

CHARACTERISTIC	SYMBOL	AC10DGM	AC10EGM	AC10FGM	UNIT	NOTE
Repetitive Peak off Voltage	$V_{DRM}$	400	500	600	V	
Non-repetitive Peak off Voltage	$V_{DSM}$	500	600	700	V	
RMS On-State Current	$I_T$ (RMS)	10 ( $T_C = 103^\circ\text{C}$ )			A	See Fig. 11, 12
Peak Surge On-State Current	$I_{TSM}$	80 (50Hz, Non-repetitive)			A	See Fig. 2
Fusing Current	$\int i_T^2 dt$	28 ( $1\text{ ms} \leq t \leq 10\text{ ms}$ )			$\text{A}^2\text{s}$	
Peak Gate Power Dissipation	$P_{GM}$	5.0			W	
Average Gate Power Dissipation	$P_G$ (AV)	0.5			W	
Peak Gate Current	$I_{FGM}$	$\pm 3$			A	
Junction Temperature	$T_j$	-40 to +125			$^\circ\text{C}$	
Storage Temperature	$T_{stg}$	-40 to +125			$^\circ\text{C}$	

ELECTRICAL CHARACTERISTICS ( $T_j = 25^\circ\text{C}$ )

CHARACTERISTIC	SYMBOL	TEST CONDITIONS	MIN.	TYP.	MAX.	UNIT	NOTE
Peak off-State Current	$I_{\text{DRM}}$	$T_j = 125^\circ\text{C}$ , $V_{\text{DM}} = V_{\text{DRM}}$	—	—	2	mA	
On-State Voltage	$V_{\text{TM}}$	$I_{\text{TM}} = 10\text{ A}$	—	—	1.4	V	See Fig. 1
Gate Trigger Current	Trigger Mode I II III IV	$I_{\text{GT}}$ $V_{\text{DM}} = 12\text{ V}$ $R_L = 30\ \Omega$	—	—	30	mA	See Fig. 3 Fig. 4
			—	—	80		
			—	—	30		
			—	—	30		
Gate Trigger Voltage	Trigger Mode I II III IV	$V_{\text{GT}}$ $V_{\text{DM}} = 12\text{ V}$ $R_L = 30\ \Omega$	—	—	1.5	V	See Fig. 3 Fig. 4
			—	—	2.0		
			—	—	1.5		
			—	—	1.5		
Gate Non-Trigger Voltage	$V_{\text{GD}}$	$T_j = 125^\circ\text{C}$ $V_{\text{DM}} = 1/2 V_{\text{DRM}}$	0.3	—	—	V	
Commutating dv/dt	(dv/dt) C	$T_j = 125^\circ\text{C}$ (di <sub>T</sub> /dt) C = -5 A/ms $V_D = 400\text{ V}$	10	—	—	V/ $\mu\text{s}$	
Holding Current	$I_{\text{H}}$	$V_D = 24\text{ V}$	—	30	—	mA	
Thermal Resistance	$R_{\text{th}}$ (j-c)	Junction to Case	—	—	1.8	$^\circ\text{C}/\text{W}$	See Fig. 13

Trigger Mode & Test Circuit

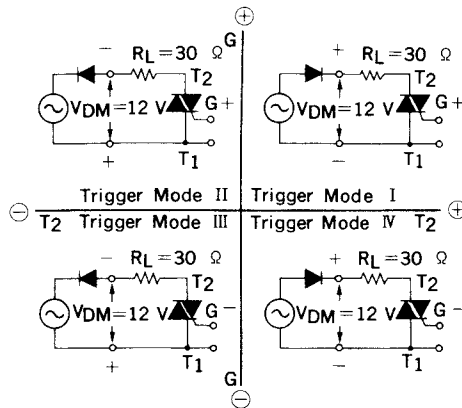

Fig. 1  $i_T - v_T$  CHARACTERISTIC

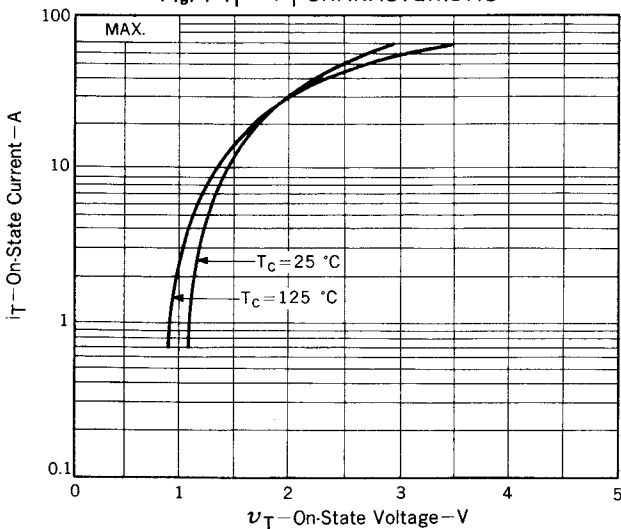

Fig. 2  $I_{\text{TSM}}$  RATING

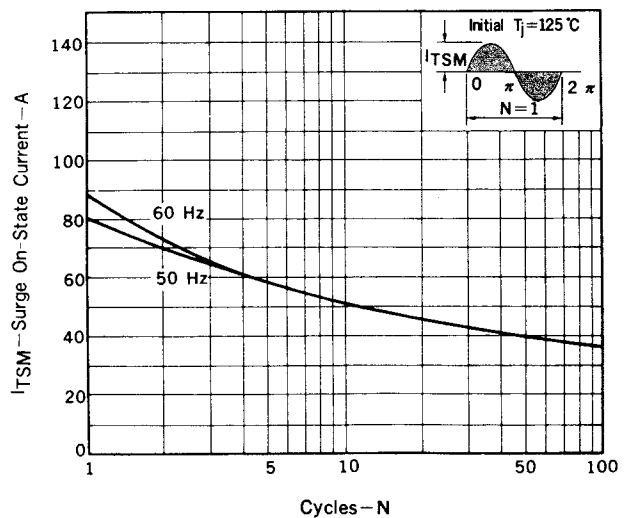

Fig. 3  $V_G - I_G$  RATING

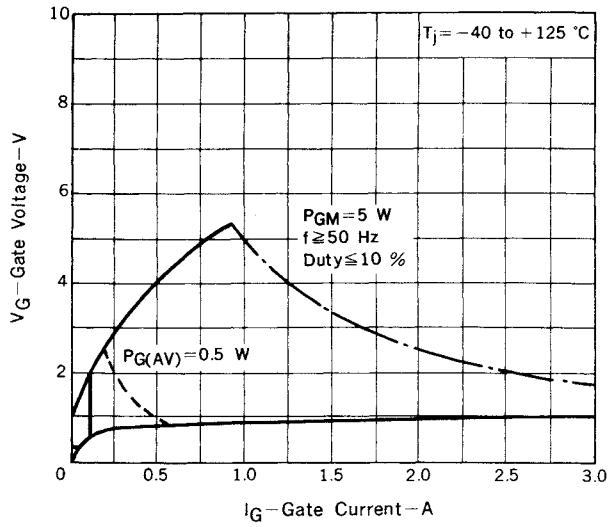

Fig. 4  $V_{GT} - I_{GT}$  CHARACTERISTIC

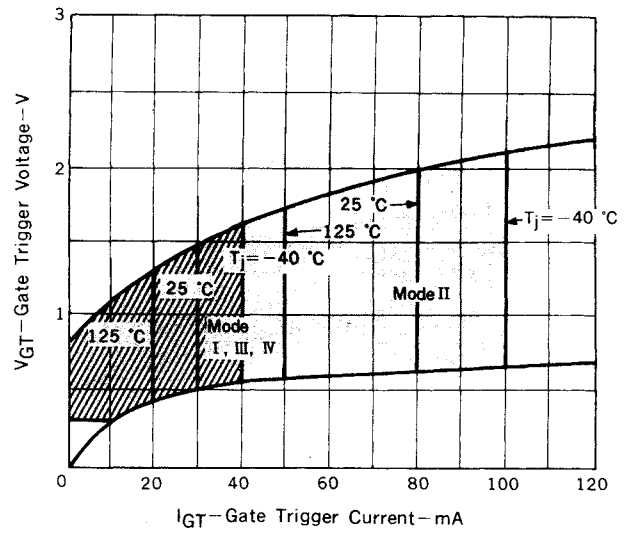

Fig. 5  $I_{GT} - T_a$  TYPICAL DISTRIBUTION

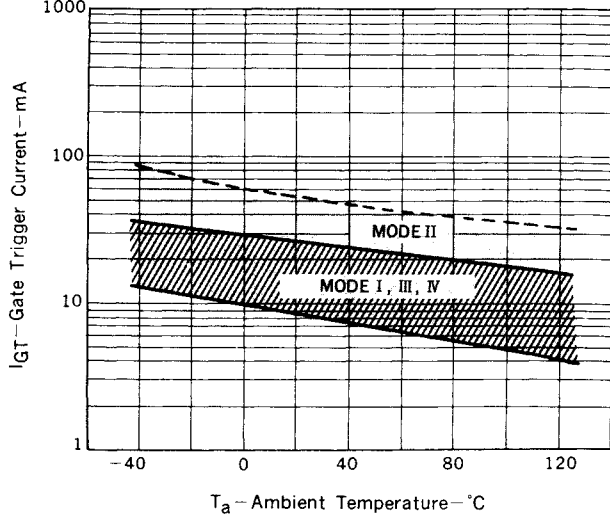

Fig. 6  $V_{GT} - T_a$  TYPICAL DISTRIBUTION

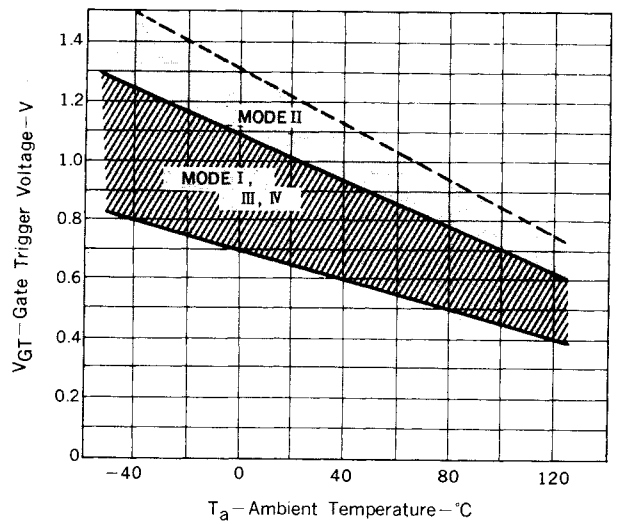

Fig. 7  $i_{GT} - \tau$  TYPICAL DISTRIBUTION

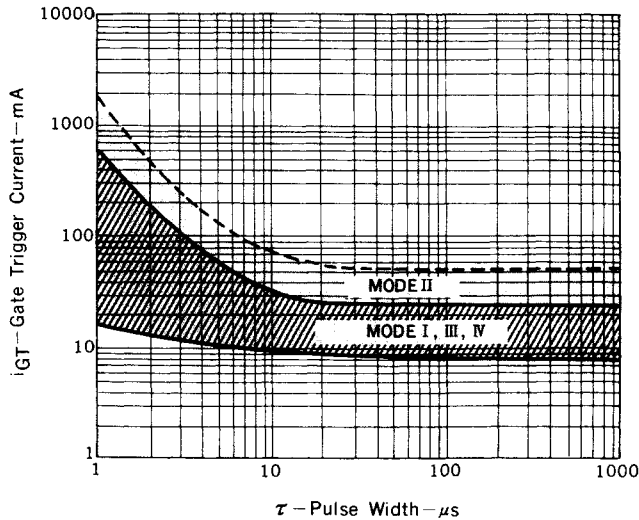

Fig. 8  $v_{GT} - \tau$  TYPICAL DISTRIBUTION

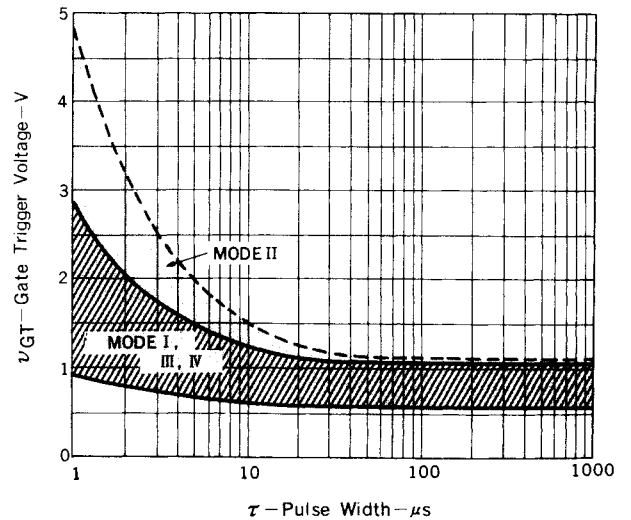

Fig. 9  $I_H - T_a$  TYPICAL DISTRIBUTION

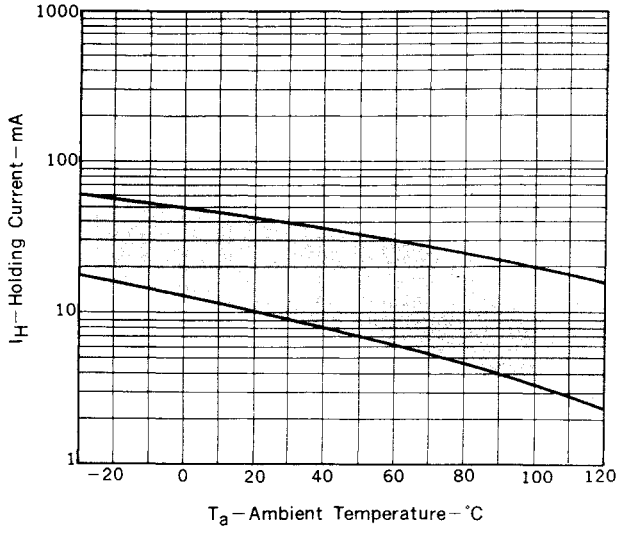

Fig. 10  $P_{T(AV)} - I_T(RMS)$  CHARACTERISTIC

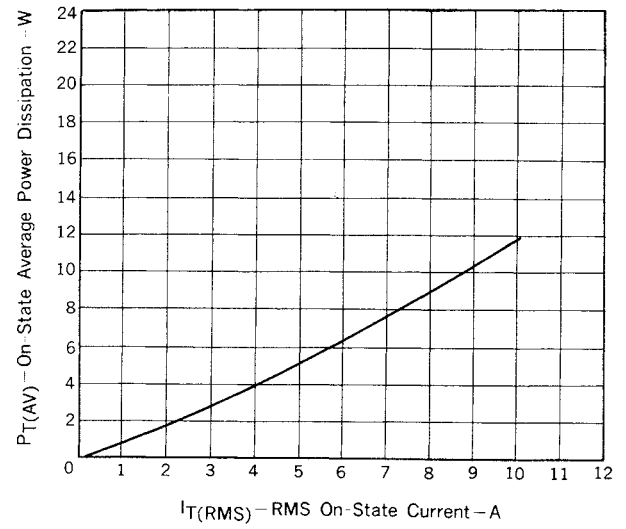

Fig. 11  $T_c - I_T(RMS)$  RATING

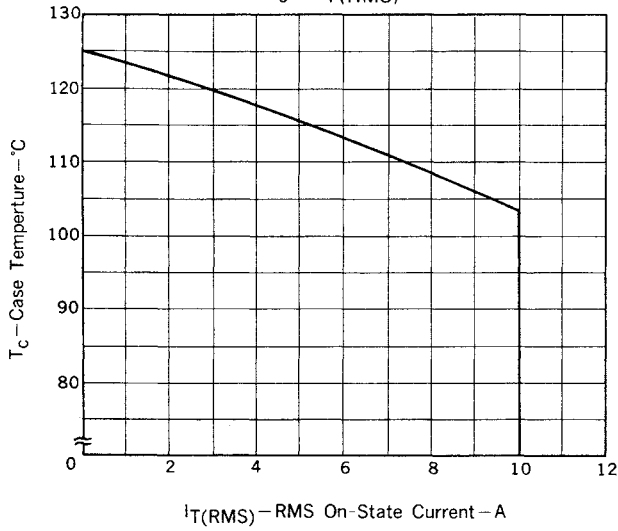

Fig. 12  $T_a - I_T(RMS)$  RATING

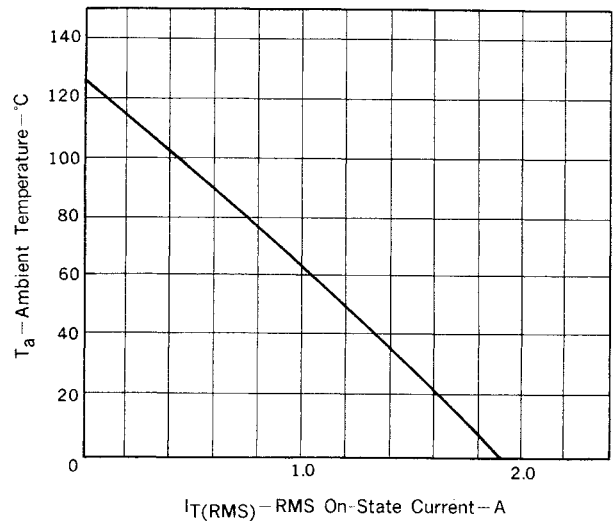
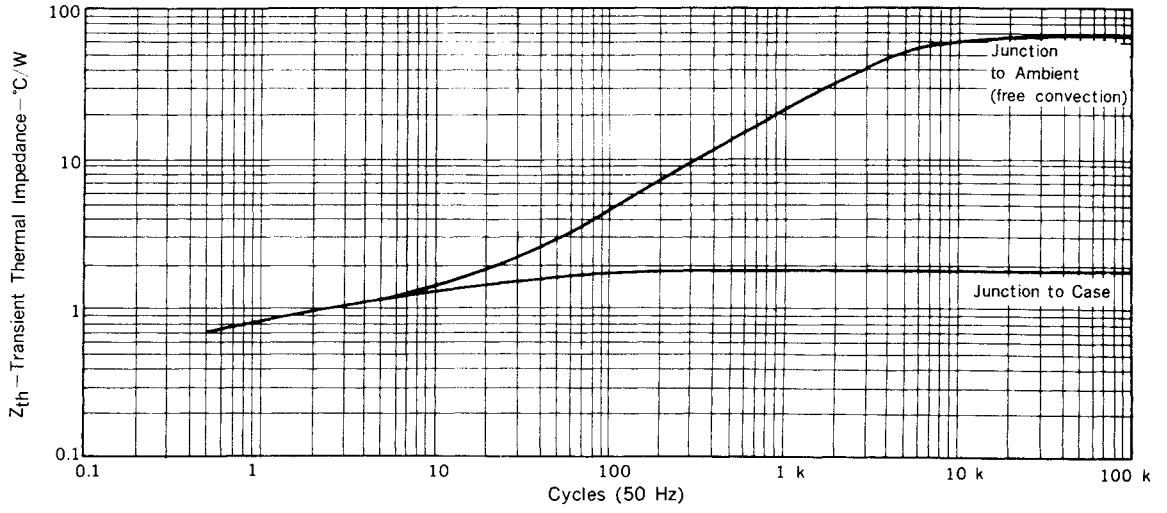

Fig. 13  $Z_{th}$  CHARACTERISTIC



---

## NEC Corporation

INTERNATIONAL ELECTRON DEVICES DIV.  
SUMITOMO MITA Building, 37-8,  
Shiba Gochome, Minato-ku, Tokyo 108, Japan  
Tel: Tokyo 456-3111  
Telex Address: NECTOK J22686  
Cable Address: NEC TOKYO