

Quad, Wide Supply Range 3V~36V, Low Power 25μA/ch Rail-to-Rail Output Operational Amplifier

■ GENERAL DESCRIPTION

The **NJM8524** is a Rail-to-Rail output quad operational amplifier that operates from a single supply of 3V to 36V, with low supply current 25μA/ch ($V_{CC} = 5V$) and low offset voltage 1.8mV max.

Rail-to-Rail output can secure output dynamic range easily. An input common-mode voltage range that includes GND is suitable for single supply applications.

■ PACKAGE OUTLINE



NJM8524V
(SSOP14)

■ FEATURES

- Supply Current 25μA/ch (at $V_{CC}=5V$.)
- Rail-to-Rail Output 0.2V to 4.9V min. (at $V_{CC}=5V$, $R_L=20k\Omega$)
- Operation Voltage +3V to +36V
- Input Offset Voltage 1.8mV max.
- Input Bias Current 3nA typ.
- Slew Rate 0.025V/μs typ. (at $V_{CC}=5V$.)
- GBW 60kHz typ. (at $V_{CC}=5V$.)
- Over Input Voltage Tolerant UP to 40V regardless of the supply voltage
- RF Immunity Enhance the RF immunity
- Bipolar Technology
- Package SSOP14

■ APPLICATIONS

- Portable battery applications
- Portable Instrumentation

■ TYPICAL APPLICATION

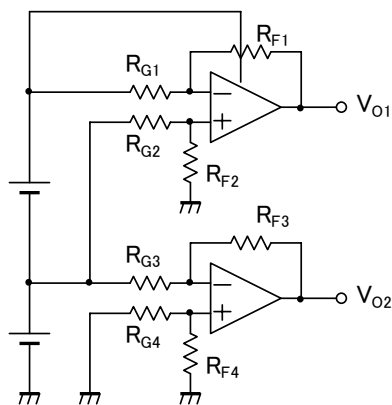

Voltage sensing circuit

■ PIN CONFIGURATION

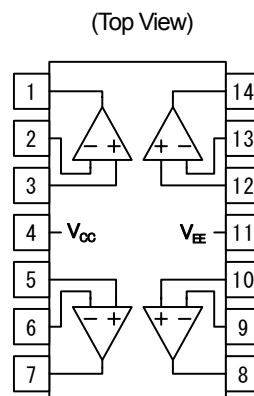

Pin Function

- | | |
|-------------|-------------|
| 1. OUTPUT 1 | 1. OUTPUT 3 |
| 2. -INPUT 1 | 2. -INPUT 3 |
| 3. +INPUT 1 | 3. +INPUT 3 |
| 4. V_{CC} | 4. V_{EE} |
| 5. +INPUT 2 | 5. +INPUT 4 |
| 6. -INPUT 2 | 6. -INPUT 4 |
| 7. OUTPUT 2 | 7. OUTPUT 4 |

NJM8524

■ ABUSOLUTE MAXIMUM RATINGS (Ta=25°C)

PARAMETER	SYMBOL	RATING	UNIT
Supply Voltage	V ⁺	+40	V
Input Voltage Range	V _{ICM}	V _{EE} -0.3 ~ V _{EE} +40 (Note1)	V
Differential Input Voltage Range	V _{ID}	±40	V
Power Dissipation (Note3)	P _D	560(Note 3)	mW
Operating Temperature Range	Topr	-40~+85	°C
Storage Temperature Range	Tstg	-55~+150	°C

(Note1) It can be applied to the input terminals regardless of the supply voltage and must be less than the rating voltage.

The normal amplifier operation input voltage is within "Common Mode Input Voltage Range" specified in the Electrical characteristics.

(Note2) See "Figure1"Power Dissipation Derating Curve" when ambient temperature is over 25°C.

(Note3) On the PCB "EIA/JEDEC (114.3×76.2×1.6mm, 2 layers, FR-4)"

Figure1
Power Dissipation Derating Curve

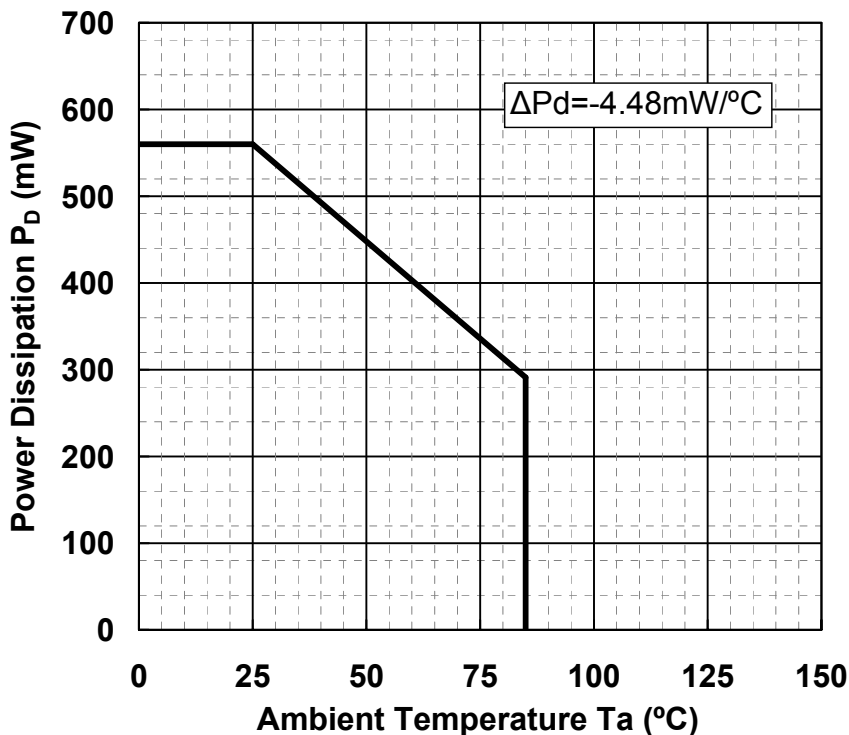

■ RECOMMENDED OPERATING VOLTAGE (Ta=-40~+85°C)

PARAMETER	SYMBOL	TEST CONDITION	MIN.	TYP.	MAX.	UNIT
Supply Voltage	V _{CC}		3	-	36	V

■ ELECTRICAL CHARACTERISTICS

● DC CHARACTERISTICS ($V_{CC}=5V$, $V_{EE}=0V$, $T_a=25^{\circ}C$, unless otherwise noted.)

PARAMETER	SYMBOL	TEST CONDITION	MIN.	TYP.	MAX.	UNIT
Supply Current	I_{CC}	No Signal	-	100	150	μA
Input Offset Voltage	V_{IO}	$R_s=50\Omega$	-	0.25	1.8	mV
Input Offset Voltage Drift	$\Delta V_{IO}/\Delta T$	$T_a = -40^{\circ}C \sim +85^{\circ}C$	-	3	-	$\mu V/deg$
Input Bias Current	I_B		-	3	30	nA
Input Offset Current	I_{IO}		-	0.5	10	nA
Voltage Gain	A_v	$V_o=1V$ to $4V$, $R_L=10k\Omega$ to $2.5V$	70	80	-	dB
Common Mode Rejection Ratio	CMR	$V_{CM}=0V \sim 3.4V$	70	95	-	dB
Supply Voltage Rejection Ratio	SVR	$V^+=3V \sim 36V$	80	100	-	dB
Maximum Output Voltage1	V_{OH1}	$R_L=20k\Omega$ to $2.5V$	4.95	4.99	-	V
	V_{OL1}	$R_L=20k\Omega$ to $2.5V$	-	0.01	0.2	V
Maximum Output Voltage2	V_{OH2}	$R_L=20k\Omega$ to $0V$	4.90	4.98	-	V
	V_{OL2}	$R_L=20k\Omega$ to $0V$	-	0.01	0.15	V
Output Current	I_{SOURCE}	$V_o = 4V$, $V_{ID}=1V$	5	6.5	-	mA
	I_{SINK}	$V_o = 1V$, $V_{ID} = -1V$	2.5	10	-	mA
Common Mode Input Voltage Range	V_{ICM}	CMR \geq 70dB	0	-	3.4	V

● AC CHARACTERISTICS ($V_{CC}=5V$, $V_{EE}=0V$, $T_a=25^{\circ}C$, unless otherwise noted.)

PARAMETER	SYMBOL	TEST CONDITION	MIN.	TYP.	MAX.	UNIT
Gain Bandwidth Product	GBW	$R_L=20k\Omega$ to $2.5V$, $C_L=10pF$	-	60	-	kHz
Phase Margin	Φ_M	$R_L=20k\Omega$ to $2.5V$, $C_L=10pF$	-	65	-	deg
Gain Margin	G_M	$R_L=20k\Omega$ to $2.5V$, $C_L=10pF$		12		dB
Equivalent Input Noise Voltage	V_{NI}	$f=100Hz$	-	80	-	nV/\sqrt{Hz}
Slew Rate	SR	(Note4), $A_v=0dB$, $R_L=20k\Omega$ to $2.5V$, $C_L=10pF$ $V_{IN}=1V_{pp}$ (2V to 3V)	-	0.025	-	V/ μs

(Note4) Number specified is the slower of the positive and negative slew rates.

NJM8524

• DC CHARACTERISTICS ($V_{CC}=30V$, $V_{EE}=0V$, $T_a=25^{\circ}C$, unless otherwise noted.)

PARAMETER	SYMBOL	TEST CONDITION	MIN.	TYP.	MAX.	UNIT
Supply Current	I_{CC}	No Signal	-	150	250	μA
Input Offset Voltage	V_{IO}	$R_s=50\Omega$	-	0.2	1.8	mV
Input Offset Voltage Drift	$\Delta V_{IO}/\Delta T$	$T_a = -40^{\circ}C \sim +85^{\circ}C$	-	3	-	$\mu V/deg$
Input Bias Current	I_B		-	3	30	nA
Input Offset Current	I_{IO}		-	0.5	10	nA
Voltage Gain	A_v	$V_o=2V$ to 28V, $R_L=10k\Omega$ to 2.5V	70	92	-	dB
Common Mode Rejection Ratio	CMR	$V_{CM}=0V \sim 28.4V$	75	95	-	dB
Supply Voltage Rejection Ratio	SVR	$V^{\pm}=3V \sim 36V$	80	100	-	dB
Maximum Output Voltage1	V_{OH1}	$R_L=20k\Omega$ to 15V	4.93	29.98	-	V
	V_{OL1}	$R_L=20k\Omega$ to 15V	-	0.05	0.2	V
Maximum Output Voltage2	V_{OH2}	$R_L=20k\Omega$ to 0V	29.90	29.93	-	V
	V_{OL2}	$R_L=20k\Omega$ to 0V	-	0.01	0.15	V
Output Current	I_{SOURCE}	$V_o = 28V$, $V_{ID}=1V$	7	8	-	mA
	I_{SINK}	$V_o = 2V$, $V_{ID} = -1V$	3	15	-	mA
Common Mode Input Voltage Range	V_{ICM}	CMR \geq 75dB	0	-	28.4	V

• AC CHARACTERISTICS ($V_{CC}=30V$, $V_{EE}=0V$, $T_a=25^{\circ}C$, unless other wise noted.)

PARAMETER	SYMBOL	TEST CONDITION	MIN.	TYP.	MAX.	UNIT
Gain Bandwidth Product	GBW	$R_L=20k\Omega$ to 15V, $C_L=10pF$	-	100	-	kHz
Phase Margin	Φ_M	$R_L=20k\Omega$ to 15V, $C_L=10pF$	-	65	-	deg
Gain Margin	G_M	$R_L=20k\Omega$ to 15V, $C_L=10pF$		10		dB
Equivalent Input Noise Voltage	V_{NI}	$f=100Hz$	-	60	-	nV/ \sqrt{Hz}
Slew Rate	SR	(Note4), $A_v=0dB$, $R_L=20k\Omega$ to 15V, $C_L=10pF$ $V_{IN}=1V_{pp}$ (12.5V to 17.5V)	-	0.04	-	V/ μs

(Note4) Number specified is the slower of the positive and negative slew rates.

■ TYPICAL CHARACTERISTICS

Supply Current vs. Supply Voltage

$V_{ICM}=V_{CC}/2, G_v=0dB$

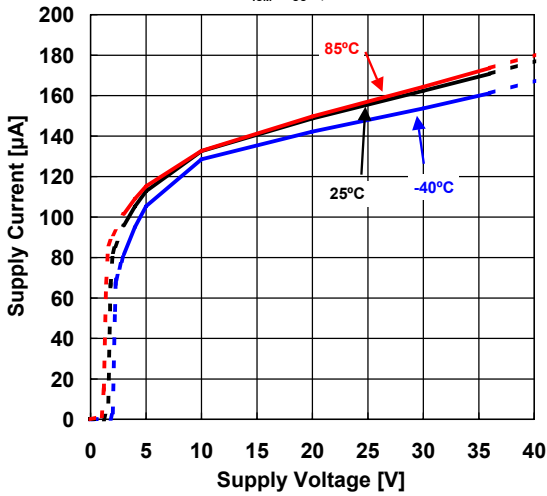

Supply Current vs. Temperature

$V_{ICM}=V_{CC}/2, G_v=0dB$

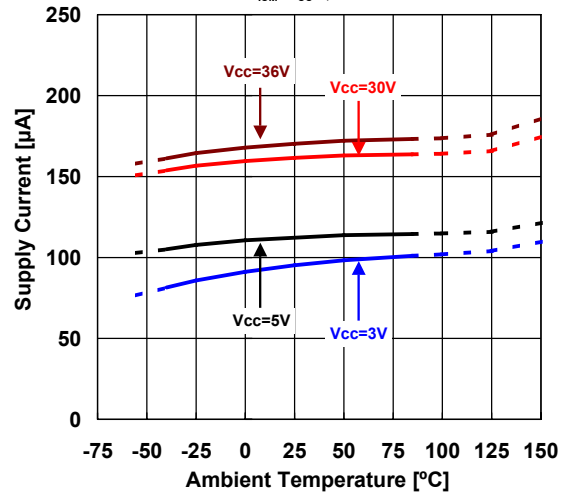

Input Offset Voltage Distribution

$V_{CC}=5V, V_{ICM}=2.5V, T_a=25^\circ C$

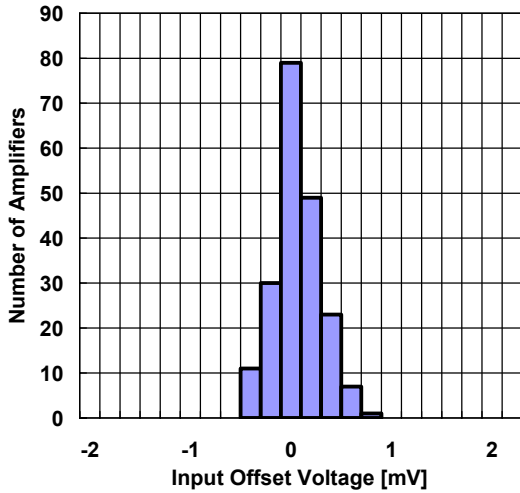

Input Offset Voltage Distribution

$V_{CC}=30V, V_{ICM}=15V, T_a=25^\circ C$

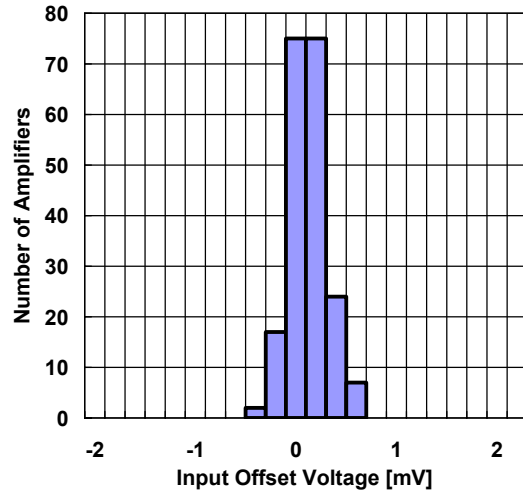

Input Offset Voltage vs. Temperature

$V_{CC}=5V, V_{ICM}=2.5V$

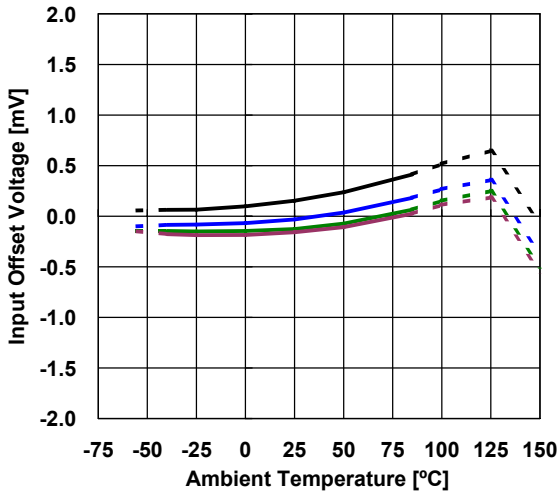

Input Offset Voltage vs. Temperature

$V_{CC}=30V, V_{ICM}=15V$

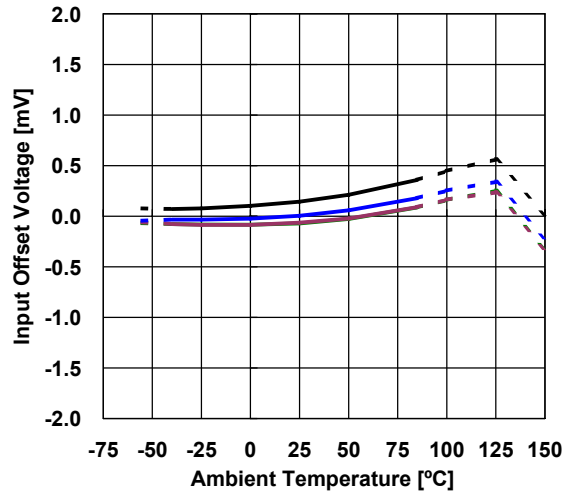

■ TYPICAL CHARACTERISTICS

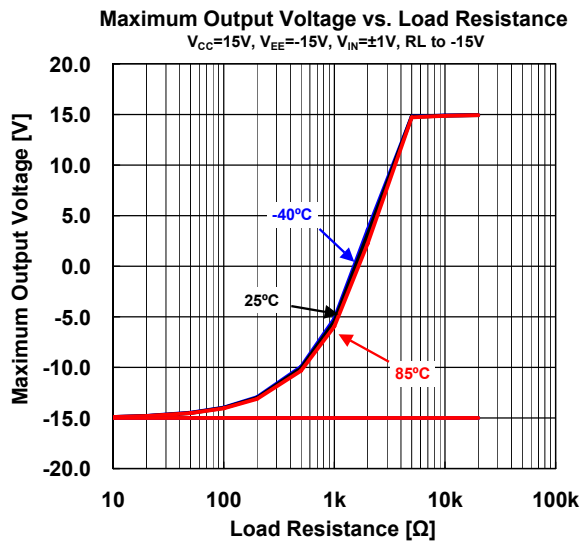
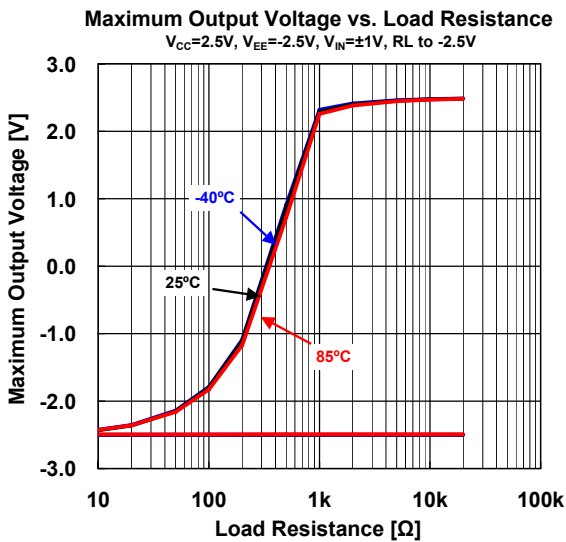
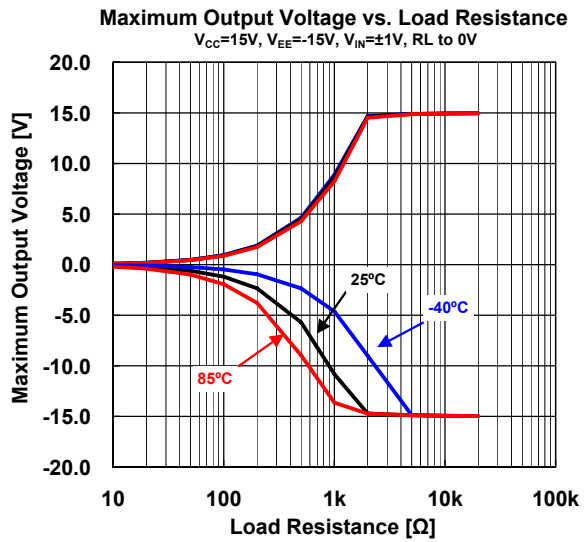
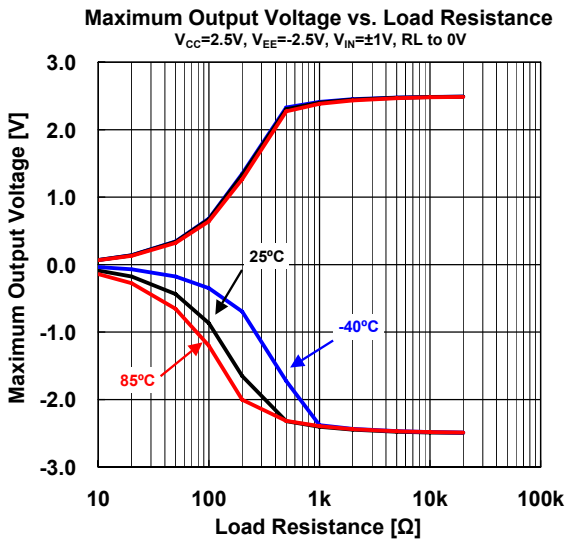
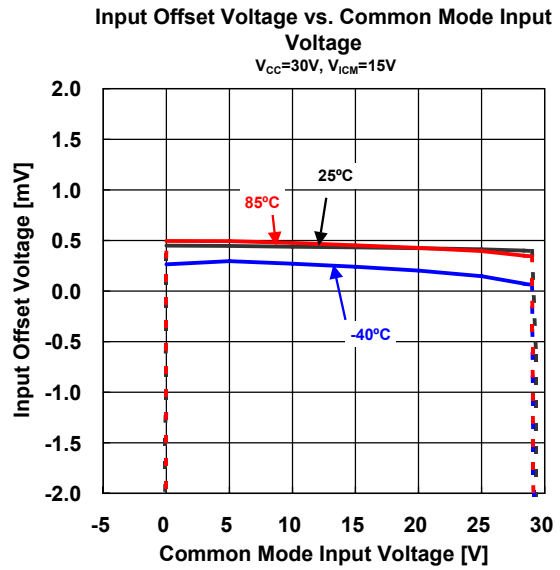
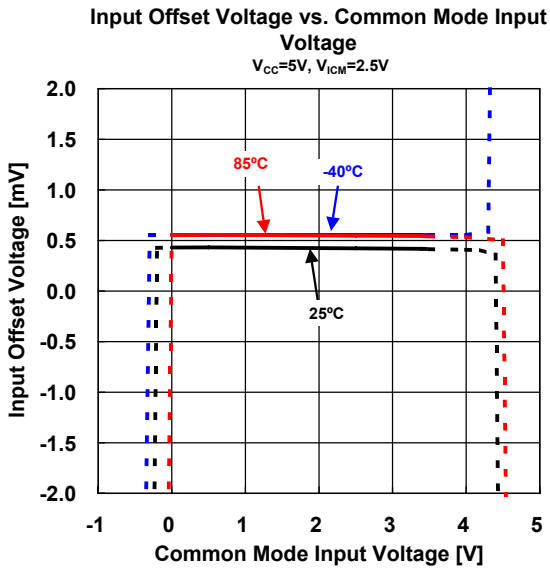

■ TYPICAL CHARACTERISTICS

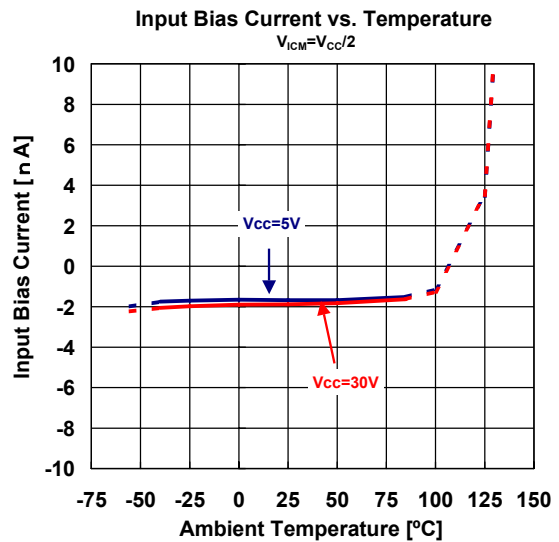
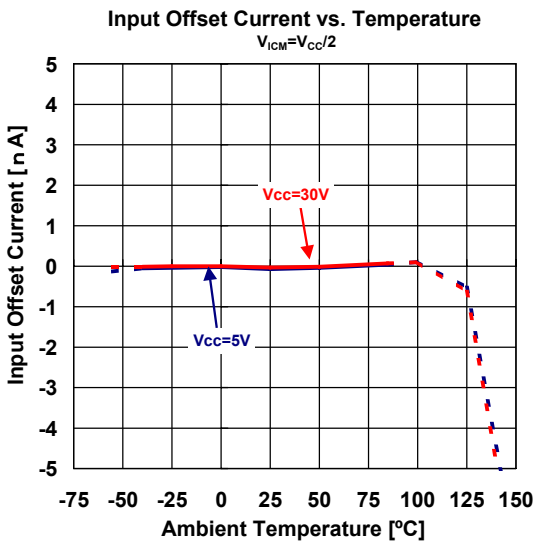
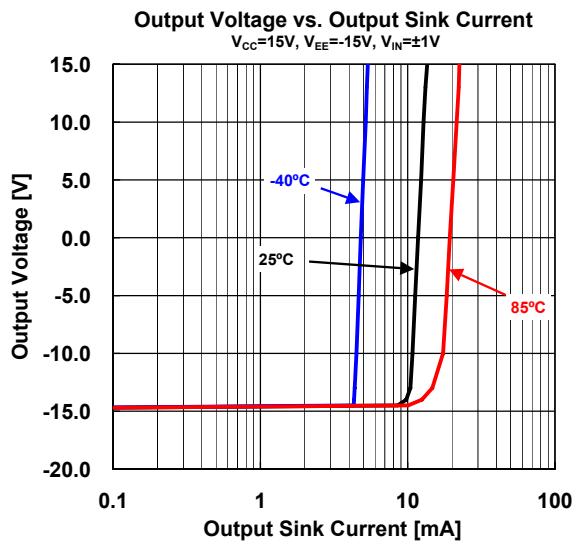
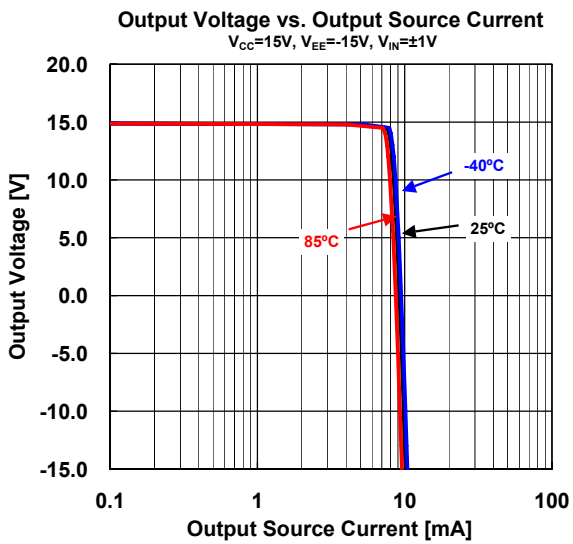
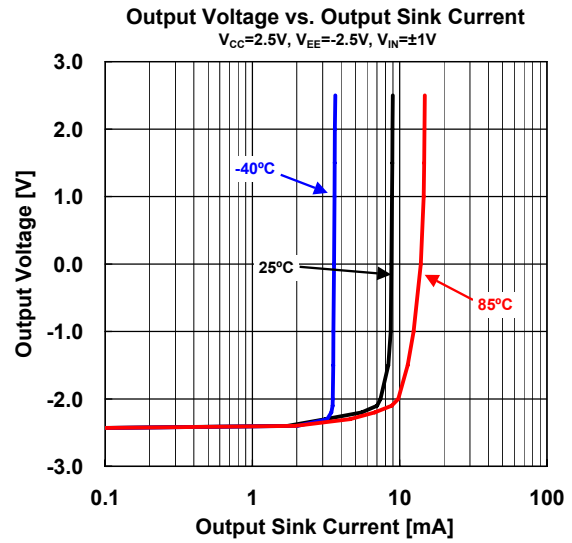
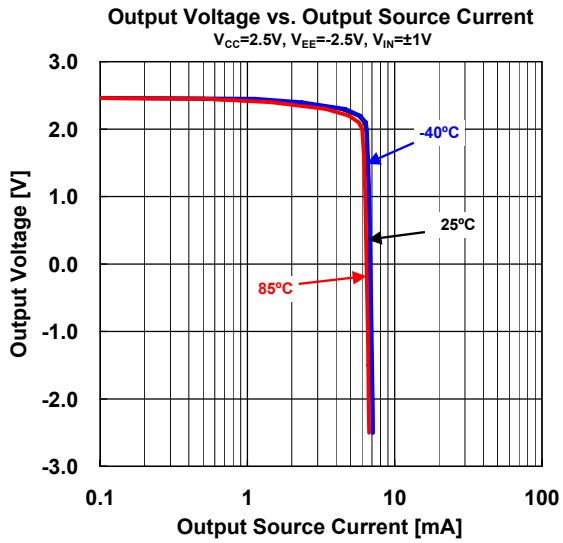

■ TYPICAL CHARACTERISTICS

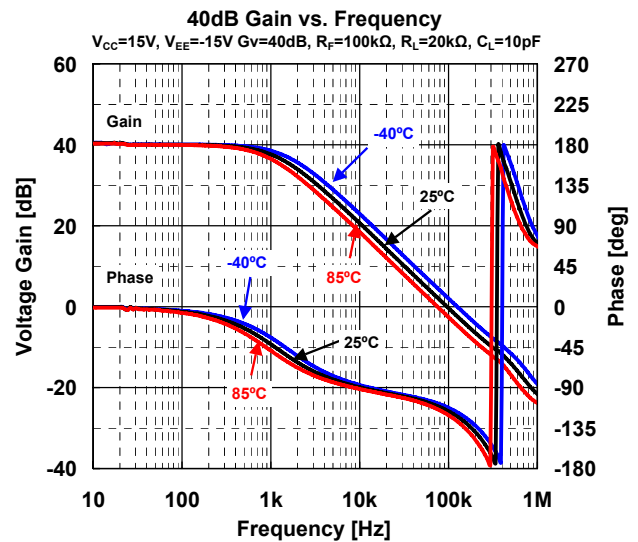
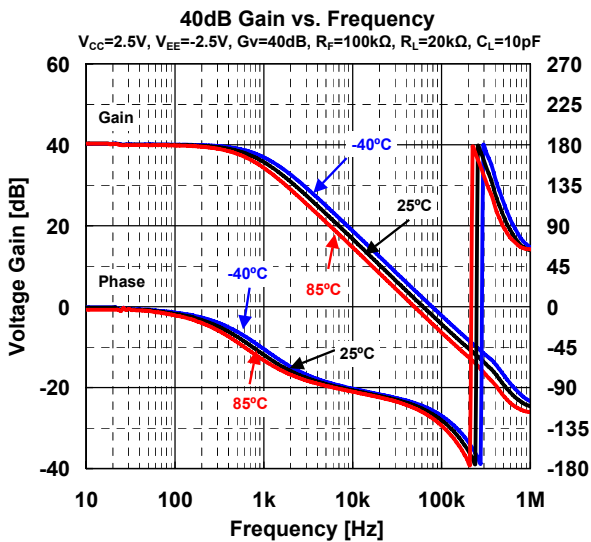
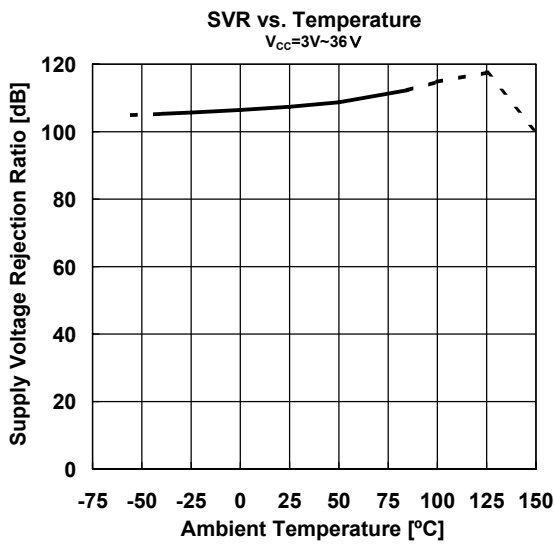
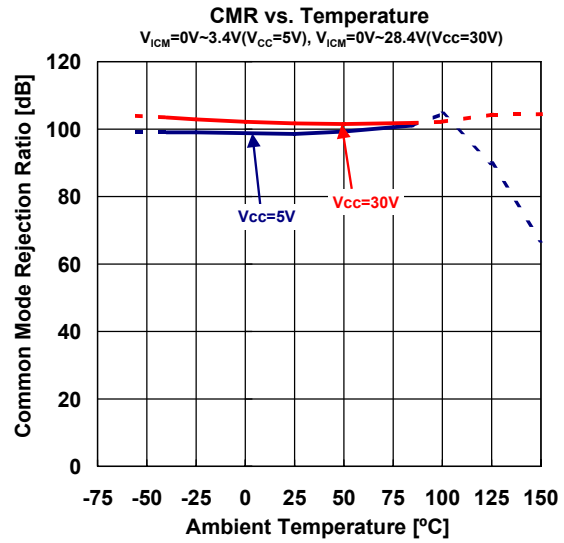
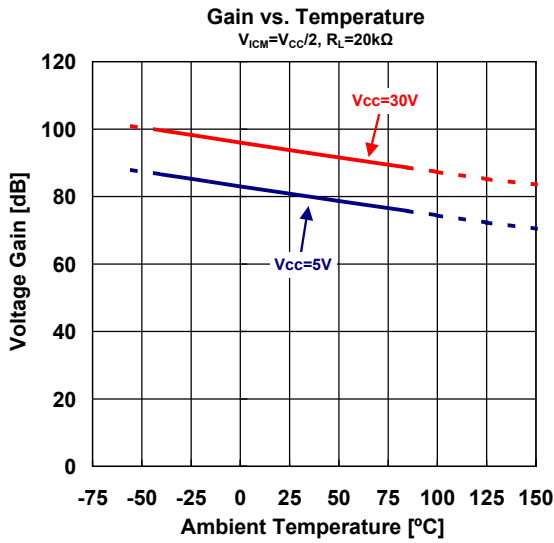

■ TYPICAL CHARACTERISTICS

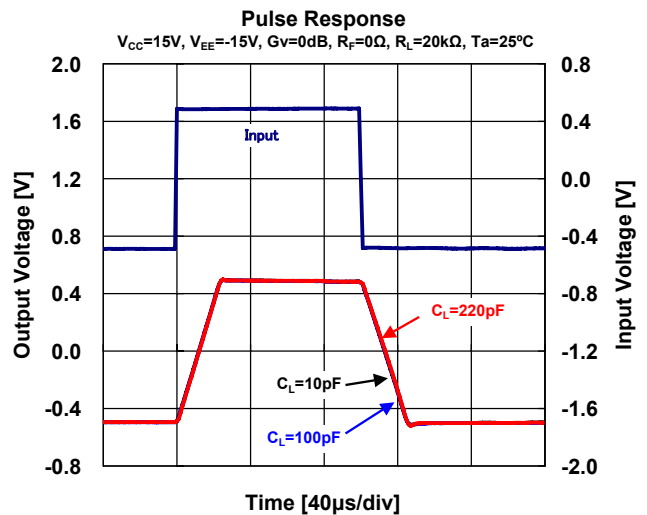
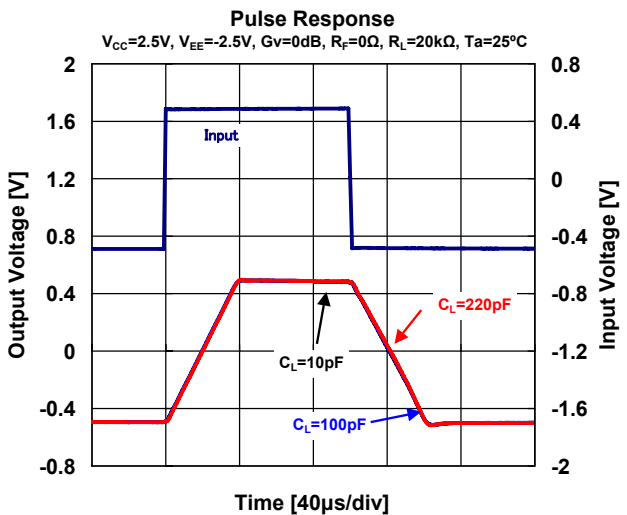
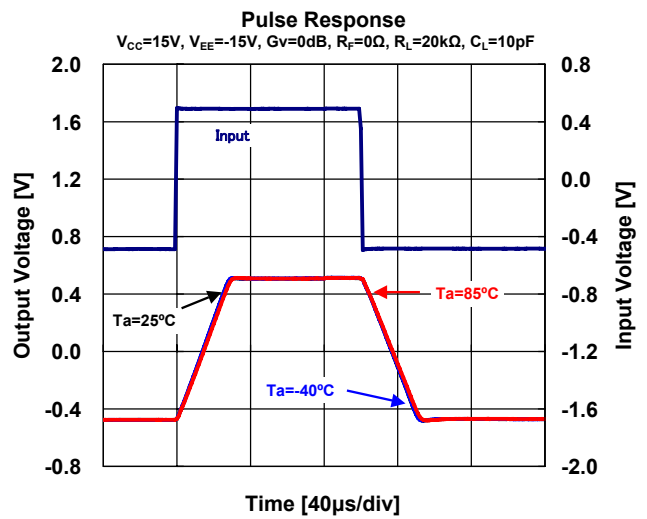
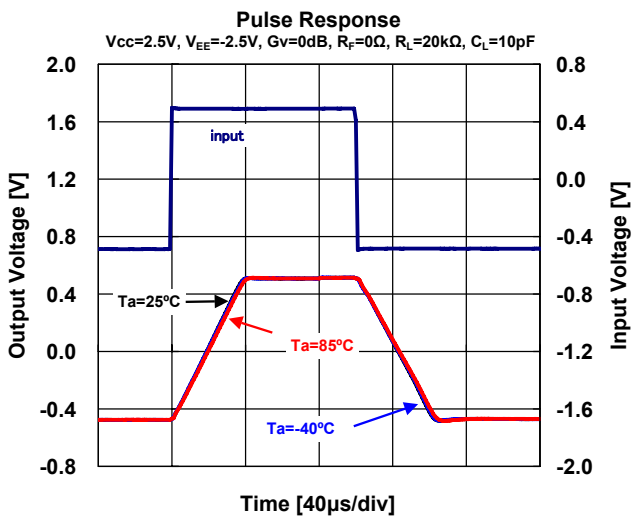
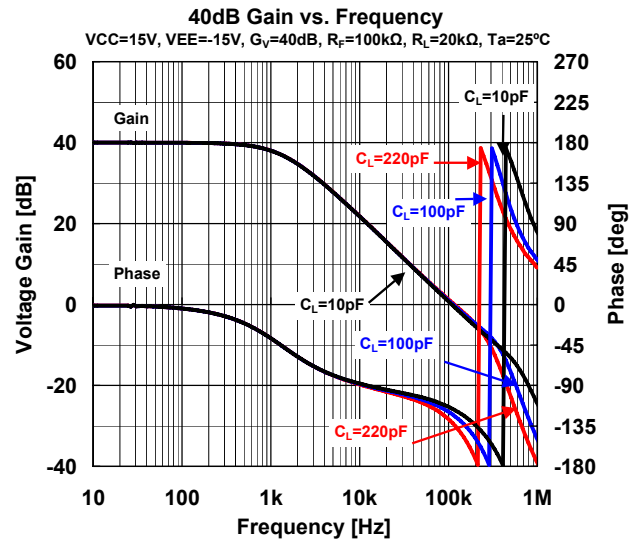
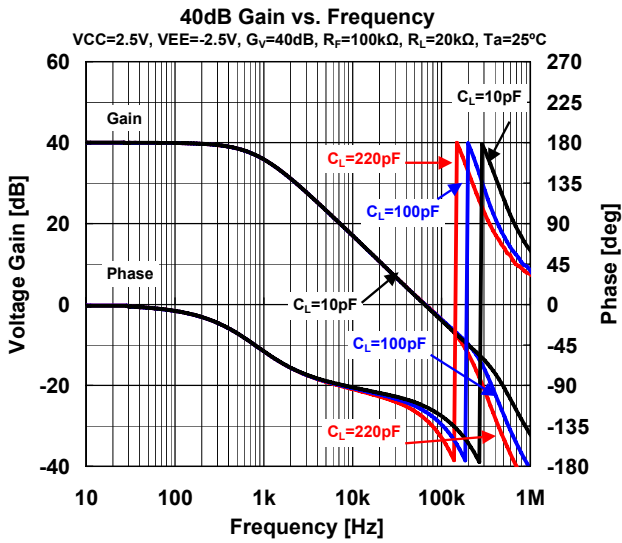

■ MEMO

[CAUTION]
The specifications on this data book are only given for information, without any guarantee as regards either mistakes or omissions. The application circuits in this data book are described only to show representative usages of the product and not intended for the guarantee or permission of any right including the industrial rights.