

SONY[®]

LCD Colour TV

Operating Instructions

KLV-40S400A

KLV-37S400A

KLV-32S400A

KLV-26S400A

BRAVIA

Introduction

Thank you for choosing this Sony product.
Before operating the TV, please read this manual thoroughly and retain it for future reference.

The illustrations used in this manual are of the KLV-32S400A unless otherwise stated.

Trademark information

- HDMI, the HDMI logo and High-Definition Multimedia Interface are trademarks or registered trademarks of HDMI Licensing LLC.
- “BRAVIA” and BRAVIA are trademarks of Sony Corporation.



Notes for New Zealand model

Your Bravia TV is ENERGY STAR qualified in the home mode.

- When the TV is initially set up, it is designed to meet ENERGY STAR requirements.
- Changes to certain features, settings, and functionalities of this TV (i.e. TV Guide, Picture/Sound, Light Sensor, Power Savings) can slightly change the power consumption.

Depending upon such changed settings, the power consumption may increase which possibly could exceed the limit required for ENERGY STAR qualification.

Table of Contents

Start-up Guide

4

Checking the accessories	4
Inserting batteries into the remote.....	4
1: Attaching the stand	4
2: Connecting an antenna/cable/VCR.....	5
3: Preventing the TV from toppling over.....	5
4: Bundling the cables.....	6
5: Connecting the AC power cord	6
6: Performing the initial set-up	6
Selecting the language.....	6
Auto-tuning the TV	7
Watching TV	8
Adjusting the viewing angle of the TV	8
Adjust the angle left and right (swivel)	8
Detaching the Table-Top Stand from the TV.....	8
Safety information	9
Precautions	10
Overview of the remote	11
Using the Tools menu	13
Overview of the TV buttons and indicators	14

Using Optional Equipment

Connecting optional equipment.....	15
Viewing pictures from the connected equipment	16
Viewing Twin Picture	17
Viewing PIP (Picture in Picture)	17
Using BRAVIA Sync (Control for HDMI) ...	18
To connect the equipment that is compatible with control for HDMI	18
To make the control for HDMI settings	18
Control for HDMI	18

Using MENU Functions

Navigating through menus.....	19
Using the Favourite List.....	20
Settings adjustment	21
Picture menu	23
Sound menu.....	24
Screen menu	25
Set-up menu.....	26
PC Settings menu.....	28
Channel Set-up menu	30

Additional Information

Specifications	32
Troubleshooting.....	33

Start-up Guide

Checking the accessories

AC power cord* (KLV-40S400A only)

Stand (1) and screws (3)

Remote RM-GA011 (1)

Size AA batteries (R6 type) (2)

* For models with ferrite cores, do not remove these cores.

Inserting batteries into the remote

Push and lift the cover to open.

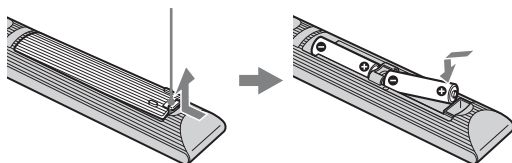

- Observe the correct polarity when inserting batteries.
- Do not use different types of batteries together or mix old and new batteries.
- Dispose of batteries in an environmentally friendly way. Certain regions may regulate the disposal of batteries. Please consult your local authority.
- Handle the remote with care. Do not drop or step on it, or spill liquid of any kind onto it.
- Do not place the remote in a location near a heat source, a place subject to direct sunlight, or a damp room.

1: Attaching the stand

1

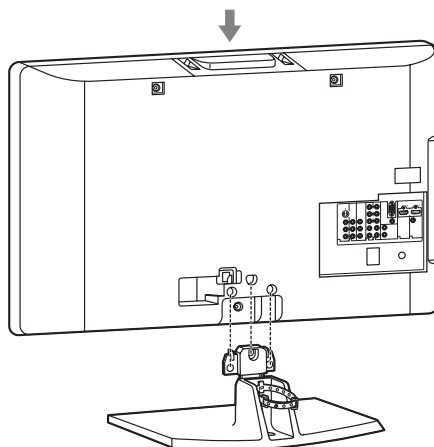

2

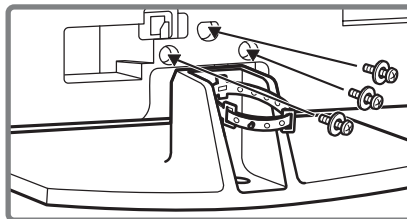

- 1 Place the TV onto the stand by aligning the screw hole alignment lines over the stand as shown.
- 2 Fix the TV to the stand according to the arrow marks  that guide the screw holes using the supplied screws.

- This TV is very heavy, so two or more people should place the TV on the stand.
- If using an electric screwdriver, set the tightening torque at approximately 1.5N·m (15kgf·cm).
- When installing the TV onto the wall, follow step 1 to prevent the TV panel from falling over.
- Ensure the AC power cord is away from screw holes during stand installation to avoid damage to the AC power cord (KLV-37S400A/KLV-32S400A/KLV-26S400A only).

2: Connecting an antenna/cable/VCR

Connecting an antenna/cable

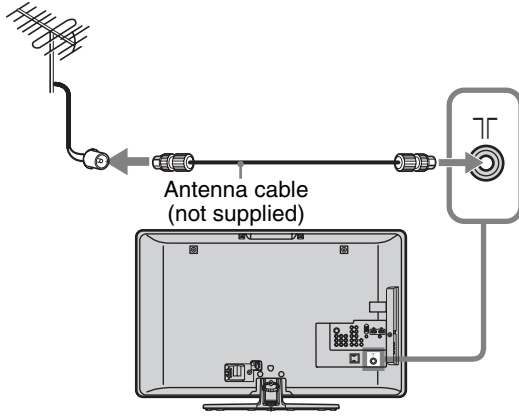

Connecting an antenna/cable and VCR

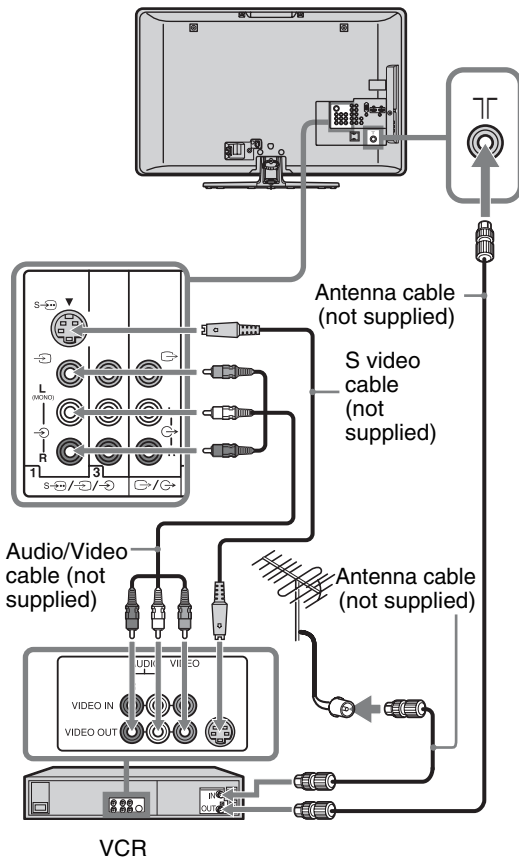

3: Preventing the TV from toppling over

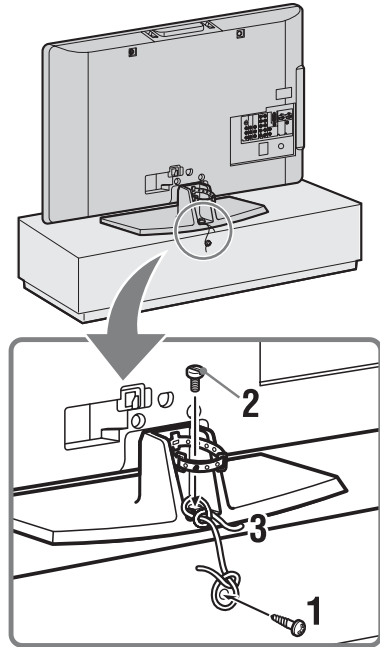

- 1** Install a wood screw (4 mm in diameter, not supplied) in the TV stand.
- 2** Install a machine screw (M6 x 12, not supplied) into the screw hole of the TV.
- 3** Tie the wood screw and the machine screw with a strong cord.

4: Bundling the cables

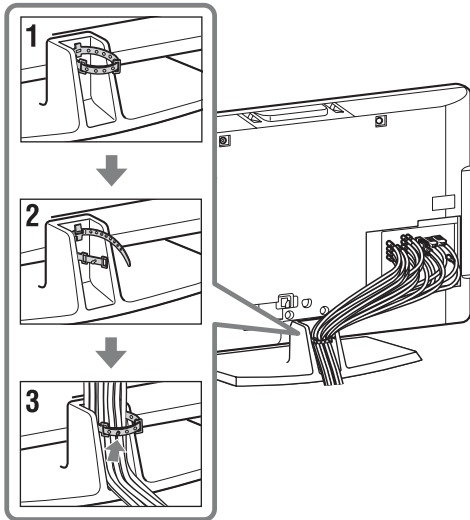

5: Connecting the AC power cord

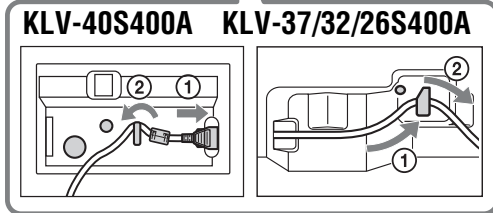
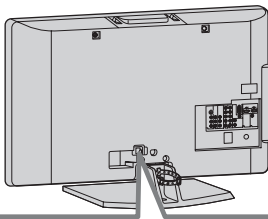

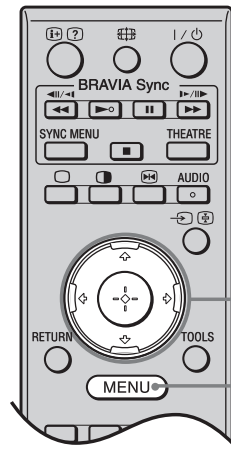
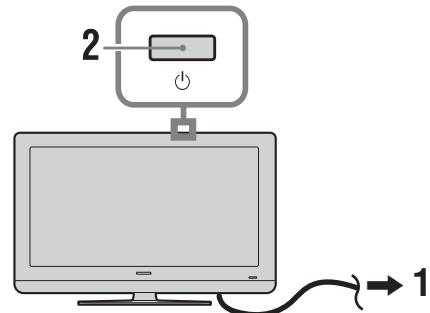

* Type of AC power cord supplied (with or without ferrite core) varies depending on the countries.

6: Performing the initial set-up



3, 4, 5, 6, 9,
10, 11
8

Selecting the language

- 1 Connect the TV to your AC power outlet (110-240 V AC, 50/60 Hz) (New Zealand only: 220-240 V AC, 50/60 Hz).
- 2 Press  on the top edge of the TV. When the TV is in standby mode (the  (standby) indicator on the TV front panel is red), press  on the remote to turn on the TV. When you turn on the TV for the first time, the “Language” menu appears on the screen.

- 3 Press \uparrow/\downarrow to select the language displayed on the menu screens, then press \oplus .

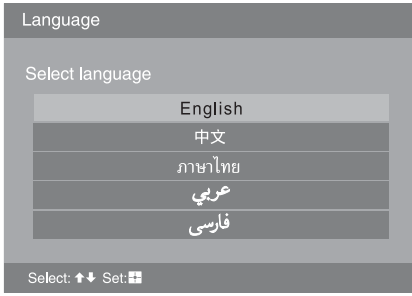

- 4 Press \uparrow/\downarrow to select the country/region, then press \oplus .



- Area 1: Asia (except Philippines), Middle East, Africa and Oceania.
- Area 2: Philippines.

- 5 Press \uparrow/\downarrow to select "Home", then press \oplus .



► For New Zealand model

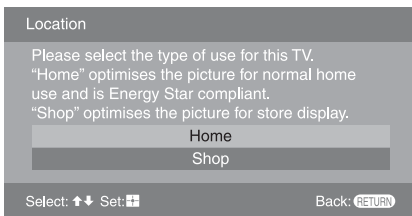

Auto-tuning the TV

- 6 Press \leftarrow/\rightarrow to select "OK", then press \oplus .

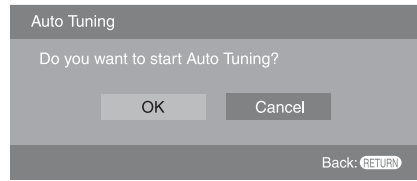

The TV starts searching for all available channels. This may take some time, please be patient and do not press any buttons on the TV or remote.

If a message appears for you to confirm the antenna connection

No programmes found. Please connect antenna (aerial) and select "Confirm" to start auto-tuning again. If 100 channels are found, auto-tuning is stopped.

- 7 When the "Programme Sorting" menu appears on the screen, follow the steps of "Programme Sorting" (page 30).

If you do not change the order in which the channels are stored on the TV, go to step 8.

- 8 Press MENU to exit.

The TV has now tuned in all the available channels.

- 9 Select day and time.

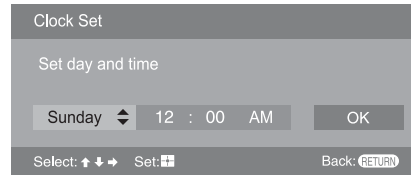

- 10 Select "Yes" to link the operations of the TV and the connected equipment that is compatible with control for HDMI automatically.

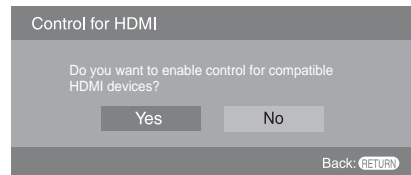

- 11 Press \leftarrow/\rightarrow to select the desired setting in "Display this menu next time?" dialogue, then press \oplus to exit.

- If "Yes" is selected and the TV is turned off by pressing $\text{\textcircled{P}}$ on the TV, or is disconnected from the AC power outlet, the initial set-up procedure restarts the next time the TV is turned on.

Watching TV

- 1 Press \odot on the top edge of the TV to turn on the TV.
- 2 Press the number buttons or PROG +/- to select a TV channel.
- 3 Press \triangle +/- to adjust the volume.

Adjusting the viewing angle of the TV

This TV can be adjusted within the angles shown below.

Adjust the angle left and right (swivel)

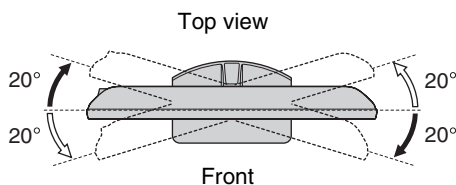

Detaching the Table-Top Stand from the TV

Remove the screws guided by the arrow marks \uparrow of the TV.

Do not remove the Table-Top Stand for any reason other than to wall-mount the TV.

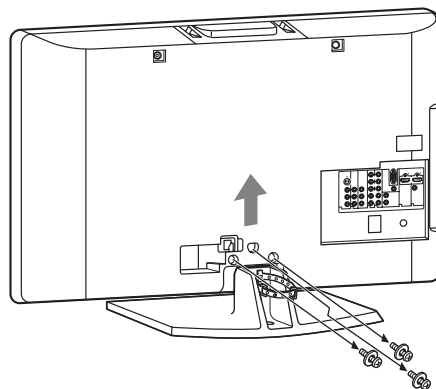

- For bracket installation, refer to the instruction guide provided by the Wall-Mount Bracket model for your TV. Sufficient expertise is required in installing this TV, especially to determine the strength of the wall for withstanding the TV's weight. **For product protection and safety reasons, Sony strongly recommends that you use the Wall-Mount Bracket model designed for your TV and the wall-mounting of your TV should be performed by Sony dealers or licensed contractors.**

Safety information

Installation/Set-up

Install and use the TV set in accordance with the instructions below in order to avoid any risk of fire, electrical shock or damage and/or injuries.

Installation

- The TV set should be installed near an easily accessible AC power outlet.
- Place the TV set on a stable, level surface to avoid it from falling down and cause personal injury or damage to the TV.
- Only qualified service personnel should carry out wall installations.
- For safety reasons, it is strongly recommended that you use Sony accessories, including:
 - KLV-40S400A/KLV-37S400A/KLV-32S400A: Wall-mount bracket SU-WL500 and SU-WL50B
 - KLV-26S400A: Wall-mount bracket SU-WL100
 - TV stand SU-FL300M
- Be sure to use the screws supplied with the Wall-mount bracket when attaching the mounting hooks to the TV set. The supplied screws are designed so that they are 8 mm to 12 mm in length when measured from the attaching surface of the mounting hook. The diameter and length of the screws differ depending on the Wall-mount bracket model. Use of screws other than those supplied may result in internal damage to the TV set or cause it to fall, etc.

8mm - 12mm

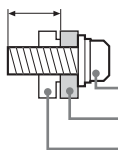

Screw (supplied with the Wall-mount bracket)
Mounting Hook
Hook attachment on rear of TV set

Transporting

- Before transporting the TV set, disconnect all cables.
- Two or more people are needed to transport a large TV set.
- When transporting the TV set by hand, hold it as shown on the right. Do not put stress on the LCD panel.
- When lifting or moving the TV set, hold it firmly from the bottom.
- When transporting the TV set, do not subject it to jolts or excessive vibration.
- When transporting the TV set for repairs or when moving, pack it using the original carton and packing material.

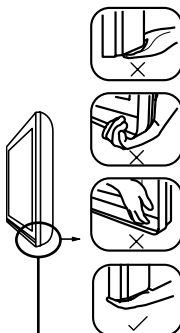
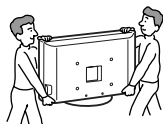

Be sure to hold the bottom of the panel, not the front part.

Ventilation

- Never cover the ventilation holes or insert anything in the cabinet.
- Leave space around the TV set as shown below.
- It is strongly recommended that you use a Sony wall-mount bracket in order to provide adequate air-circulation.

Installed on the wall

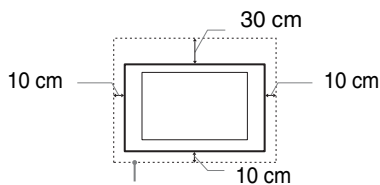

Leave at least this space around the set.

Installed with stand

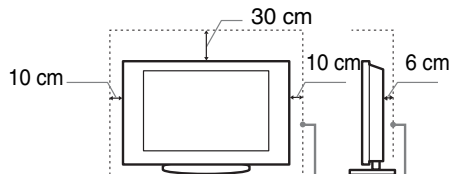

Leave at least this space around the set.

- To ensure proper ventilation and prevent the collection of dirt or dust:
 - Do not lay the TV set flat, install upside down, backwards, or sideways.
 - Do not place the TV set on a shelf, rug, bed or in a closet.
 - Do not cover the TV set with a cloth, such as curtains, or items such as newspapers, etc.
 - Do not install the TV set as shown below.

Air circulation is blocked.

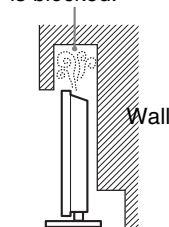

Air circulation is blocked.

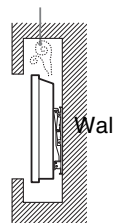

AC power cord

Handle the AC power cord and outlet as follows in order to avoid any risk of fire, electrical shock or damage and/or injuries:

- Use only Sony supplied AC power cords, not those of other brands.
- Insert the plug fully into the AC power outlet.
- Operate the TV set on a 110-240 V AC supply only (New Zealand only: 220-240 V AC).
- When wiring cables, be sure to unplug the AC power cord for your safety and take care not to catch your feet on the cables.
- Disconnect the AC power cord from the AC power outlet before working on or moving the TV set.
- Keep the AC power cord away from heat sources.
- Unplug the AC power plug and clean it regularly. If the plug is covered with dust and it picks up moisture, its insulation may deteriorate, which could result in a fire.

Notes

- Do not use the supplied AC power cord on any other equipment.
- Do not pinch, bend, or twist the AC power cord excessively. The core conductors may be exposed or broken.
- Do not modify the AC power cord.
- Do not put anything heavy on the AC power cord.
- Do not pull on the AC power cord itself when disconnecting the AC power cord.
- Do not connect too many appliances to the same AC power outlet.
- Do not use a poor fitting AC power outlet.

Continued

Prohibited Usage

Do not install/use the TV set in locations, environments or situations such as those listed below, or the TV set may malfunction and cause a fire, electrical shock, damage and/or injuries.

Location:

Outdoors (in direct sunlight), at the seashore, on a ship or other vessel, inside a vehicle, in medical institutions, unstable locations, near water, rain, moisture or smoke.

Environment:

Places that are hot, humid, or excessively dusty; where insects may enter; where it might be exposed to mechanical vibration, near flammable objects (candles, etc). The TV shall not be exposed to dripping or splashing and no objects filled with liquids, such as vases, shall be placed on the TV.

Situation:

Do not use when your hands are wet, with the cabinet removed, or with attachments not recommended by the manufacturer. Disconnect the TV set from AC power outlet and antenna during lightning storms.

Broken pieces:

- Do not throw anything at the TV set. The screen glass may break by the impact and cause serious injury.
- If the surface of the TV set cracks, do not touch it until you have unplugged the AC power cord. Otherwise electric shock may result.

When not in use

- If you will not be using the TV set for several days, the TV set should be disconnected from the AC power for environmental and safety reasons.
- As the TV set is not disconnected from the AC power when the TV set is just turned off, pull the plug from the AC power outlet to disconnect the TV set completely.
- However, some TV sets may have features that require the TV set to be left in standby to work correctly.

For children

- Do not allow children to climb on the TV set.
- Keep small accessories out of the reach of children, so that they are not mistakenly swallowed.

If the following problems occur...

Turn off the TV set and unplug the AC power cord immediately if any of the following problems occur. Ask your dealer or Sony service centre to have it checked by qualified service personnel.

When:

- AC power cord is damaged.
- Poor fitting of AC power outlet.
- TV set is damaged by being dropped, hit or having something thrown at it.
- Any liquid or solid object falls through openings in the cabinet.

Precautions

Viewing the TV

- View the TV in moderate light, as viewing the TV in poor light or during long period of time, strains your eyes.
- When using headphones, adjust the volume so as to avoid excessive levels, as hearing damage may result.

LCD Screen

- Although the LCD screen is made with high-precision technology and 99.99% or more of the pixels are effective, black dots may appear or bright points of light (red, blue, or green) may appear constantly on the LCD screen. This is a structural property of the LCD screen and is not a malfunction.
- Do not push or scratch the front filter, or place objects on top of this TV set. The image may be uneven or the LCD screen may be damaged.
- If this TV set is used in a cold place, a smear may occur in the picture or the picture may become dark. This does not indicate a failure. These phenomena disappear as the temperature rises.
- Ghosting may occur when still pictures are displayed continuously. It may disappear after a few moments.
- The screen and cabinet get warm when this TV set is in use. This is not a malfunction.
- The LCD screen contains a small amount of liquid crystal. Mercury is sometimes contained depending on the kind of fluorescent tubes. Follow your local ordinances and regulations for disposal.

Handling and cleaning the screen surface/cabinet of the TV set

Be sure to unplug the AC power cord connected to the TV set from AC power outlet before cleaning.

To avoid material degradation or screen coating degradation, observe the following precautions.

- To remove dust from the screen surface/cabinet, wipe gently with a soft cloth. If dust is persistent, wipe with a soft cloth slightly moistened with a diluted mild detergent solution.
- Never use any type of abrasive pad, alkaline/acid cleaner, scouring powder, or volatile solvent, such as alcohol, benzene, thinner or insecticide. Using such materials or maintaining prolonged contact with rubber or vinyl materials may result in damage to the screen surface and cabinet material.
- When adjusting the angle of the TV set, move it slowly so as to prevent the TV set from moving or slipping off from its table stand.

Optional Equipment

Keep optional components or any equipment emitting electromagnetic radiation away from the TV set. Otherwise picture distortion and/or noisy sound may occur.

Disposal of Old Electrical & Electronic Equipment (Applicable in the European Union and other European countries with separate collection systems)

This symbol is on the remote control.



Overview of the remote

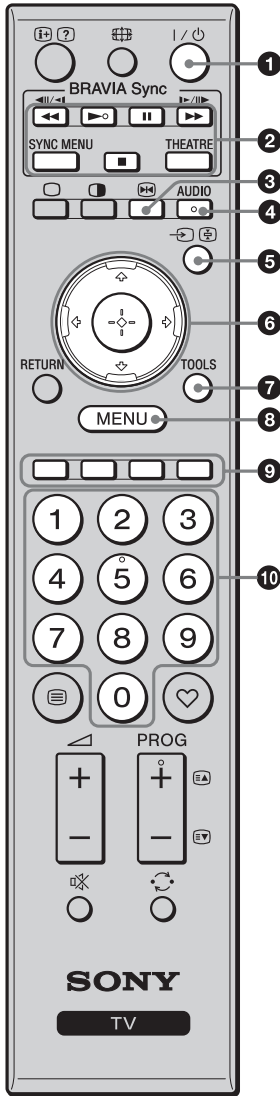

- The number 5, ►, PROG + and AUDIO buttons have tactile dots. Use the tactile dots as references when operating the TV.

1 I/⏻ – TV standby

Turns the TV on and off from standby mode.

2 BRAVIA Sync (page 18)

- ◀◀/▶▶/⏸/▶▶▶▶/■: You can operate the BRAVIA Sync-compatible equipment that is connected to the TV.
- **SYNC MENU**: Displays the menu of connected HDMI CEC (Consumer Electronics Control) equipment which is supported. While viewing other input screens or TV programmes, “HDMI Device Selection” is displayed when the button is pressed.
- **THEATRE**: You can set Theatre Mode on or off. When Theatre Mode is set to on, the optimum audio output (if the TV is connected with an audio system using an HDMI cable) and picture quality for film videos are automatically set.

- ✎ • Control for HDMI (BRAVIA Sync) is only available with the connected Sony equipment that has the BRAVIA Sync logo or is compatible with control for HDMI.
- If you turn the TV off, Theatre Mode is also turned off.

3 📺 – Picture freeze

Freezes the TV picture. Press once to display a frozen image with the current programme in a window. Press again to fill the screen with the frozen image. Press third time to return to the current programme.

Current programme
(Location of the sub
window can be moved
by pressing
⏸/◀/▶/⏸.)



Frozen picture

- ✎ • This function is not available for Twin Picture and PC input source.

4 AUDIO – Dual Sound (page 25)

5 →/⊞ – Input select / Text hold

- Displays the connected equipment list and selects the input source (page 16).
- In Text mode: Holds the current page.

6 ⏸/◀/▶/⏸/⊕ – Item select / OK

- Selects or adjusts items.
- Confirms selected items.

7 TOOLS (page 13)

8 MENU

Displays or cancels the menu.

9 Coloured buttons

In Text mode: Accesses the corresponding coloured Fastext menu quickly and easily. The Fastext feature can be used only when the Fastext broadcast is available.

10 Number buttons

- Selects channels. For channel numbers 10 and above, enter the second digit quickly (page 30).
- In Text mode: Enters the three digit page number to select the page.

Continued

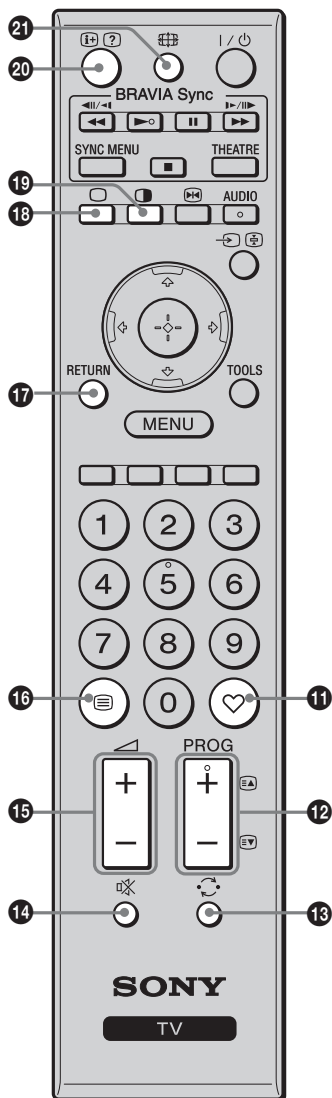

- 11** – **Favourite list**
Displays the Favourite list that you have specified (page 20).
- 12** **PROG +/-** / /
 - Selects the next (+) or previous (-) channel.
 - In Text mode: Selects the next () or previous () page.
- 13** – **Previous channel**
Returns to the previous channel watched (for more than five seconds).
- 14** – **Mute**
Press to mute the sound. Press again to restore the sound.
 - In standby mode, if you want to turn on the TV without sound, press this button.
- 15** **+/-** – **Volume**
Adjusts volume.
- 16** – **Text**
In Text mode: Displays Text broadcast: Text → Text over the TV picture (mix mode) → No Text (exit the Text service).
 - Text language displays can be either English, Persian or French depending on your broadcast signal.
- 17** **RETURN**
Returns to the previous screen of any displayed menu.
- 18** – **TV mode**
Exit Text mode, or switches to a TV display when displaying external input.
- 19** – **Twin Picture / PIP (page 17)**
Displays two pictures simultaneously.
- 20** / – **Info / Text reveal**
 - Displays information. Press once to display current channel number and screen mode. Press again to display clock information. Press third time to remove the display from the screen.
 - In Text mode: Reveals hidden information (e.g. answers to a quiz).
- 21** – **Wide Mode**
Changes the picture size. Press repeatedly to select the desired wide mode.

For TV, Video, HD/DVD or HDMI (except PC input)

Wide Zoom* 	Enlarges the centre portion of the picture. The left and right edges of the picture are stretched to fill the 16:9 screen.
Normal 	Displays the 4:3 picture in its original size. Side bars are shown to fill the 16:9 screen.
Full 	Stretches the 4:3 picture horizontally, to fill the 16:9 screen.
Zoom* 	Displays cinemascope (letter box format) broadcasts in the correct proportions.

* Parts of the top and bottom of the picture may be cut off.

• You cannot select “Normal” for HD signal source pictures.

For PC Input

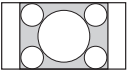
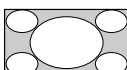
<p>Full 1</p> 	<p>Stretches the original picture to fill the screen vertically.</p>
<p>Full 2</p> 	<p>Stretches the Full 1 picture horizontally to fill the 16:9 screen.</p>

Using the Tools menu

Press TOOLS enables you to access various viewing options and change/make adjustments according to the source and screen mode. The options displayed vary depending on the input source.

Viewing TV programme

Options	Description
Picture Mode	See page 23.
Sound Mode	See page 24.
Intelligent Picture	See page 30.
MPEG Noise Reduction	See page 23.
Speaker	See page 27.
Add to Favourites	You can add the current channel to the favourite list.
Sleep Timer	See page 28.
Power Saving	See page 28.

Viewing connected equipment

Options	Description
Picture Mode (except PC input mode)	See page 23.
Display Mode (in PC input mode only)	See page 23.
Sound Mode	See page 24.
MPEG Noise Reduction (except PC input and component input mode)	See page 23.
Speaker	See page 27.
Twin Picture (except PC input mode)	See page 17.
PIP (in PC input mode only)	See page 17.
Single Picture (in Twin Picture and PIP mode only)	See page 17.
Audio Swap (in PIP mode only)	See page 17.
Auto Adjustment (in PC input mode only)	See page 28.
Horizontal Shift (in PC input mode only)	See page 29.
Sleep Timer (except PC input mode)	See page 28.
Power Saving	See page 28.
Device Control [in HDMI input mode (except HDMI PC input) only]	Displays the menu screen to operate the connected HDMI-compatible equipment.

Overview of the TV buttons and indicators

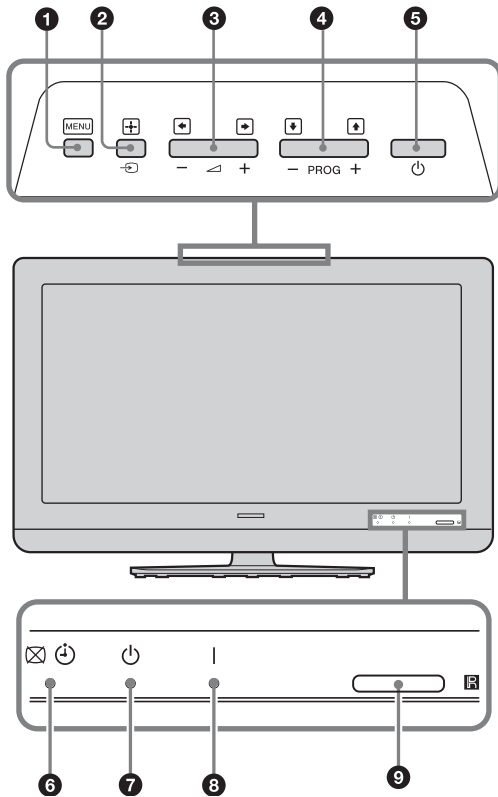

- 1 MENU**
 Displays or cancels the menu.
- 2 – Input select / OK**
 - Displays the connected equipment list and selects the input source (page 16).
 - In TV menu: Selects the menu or option, and confirms the setting.
- 3 +/- /**
 - Increases (+) or decreases (-) the volume.
 - In TV menu: Moves through the options right () or left ()
- 4 PROG +/- / /**
 - Selects the next (+) or previous (-) channel.
 - In TV menu: Moves through the options up () or down ()
- 5 – Power**
 Turns the TV on or off.
 - To disconnect the TV from the AC power completely, pull the plug from the AC power outlet.
- 6 / – Picture Off / Timer indicator**
 - Lights up in green when the picture is turned off (page 28).
 - Lights up in amber when the timer is set (page 28).
- 7 – Standby indicator**
 Lights up in red when the TV is in standby mode.
- 8 – Power indicator**
 - Lights up in green when the TV is turned on.
 - Flashes while the remote is being operated.
- 9 – Remote sensor / Light sensor (page 28)**
 - Receives IR signals from the remote.
 - Do not put anything over the sensor, as its function may be affected.

Connecting optional equipment

You can connect a wide range of optional equipment to your TV.

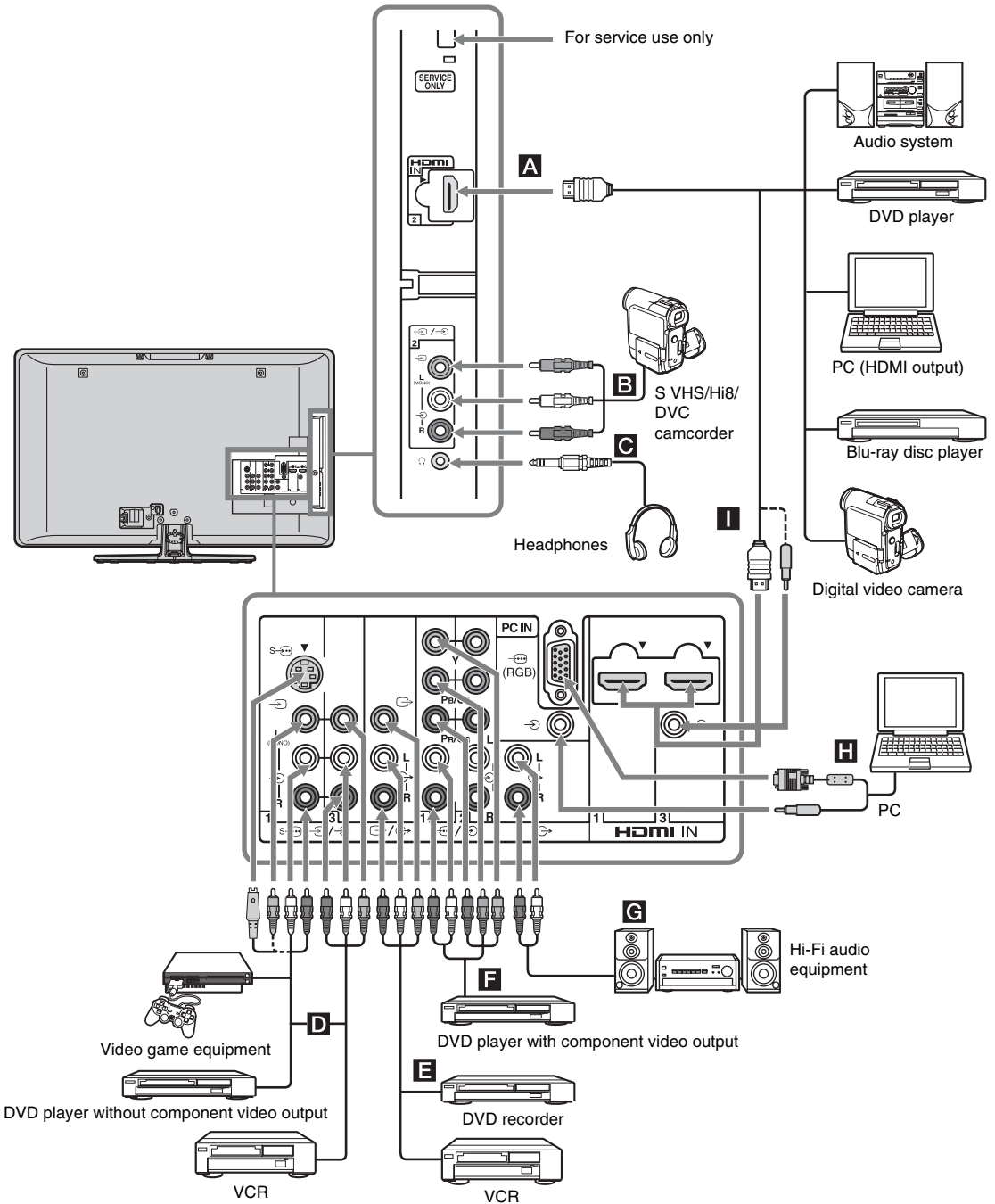

Using Optional Equipment

Continued

Viewing pictures from the connected equipment

Turn on the connected equipment, then press / to display the connected equipment list. Press to select the desired input source, then press . (The highlighted item is selected if 2 seconds pass without any operation after pressing .) When the input source is set to “Skip” in the “Video Labels” under the “AV Set-up” menu (page 26), that input does not appear in the list.

• Press / on the top edge of the TV to display the connected equipment list and select the desired input source. You can also press to select the desired input source. Then wait for 2 seconds to display the selected input source.

Jacks/ Input symbol on screen	Description
A HDMI IN 2 I HDMI IN 1 or 3 HDMI 1 or HDMI 2 or HDMI 3	<p>Connect to the HDMI IN 1, 2 or 3 jack if the equipment has an HDMI jack. The digital video and audio signals are input from the equipment. In addition, when you connect the equipment that is compatible with control for HDMI, communication with the connected equipment is supported. Refer to page 27 to set-up this communication. If the equipment has a DVI jack, connect the DVI jack to the HDMI IN 3 jack through a DVI - HDMI adaptor interface (not supplied), and connect the equipment’s audio out jack to the audio in jack in the HDMI IN 3 jack.</p> <ul style="list-style-type: none"> • The HDMI jacks only support the following video inputs: 480i, 480p, 576i, 576p, 720p (50/60 Hz), 1080i (50/60 Hz), 1080p (50/60 Hz) and 1080/24p. • Be sure to use only an HDMI cable that bears the HDMI logo (recommended Sony HDMI cable). • When connecting an audio system with HDMI jack, be sure to also connect to the audio output jacks (refer G in page 15) to listen to the sound from the TV on audio system.
B 2, and 2 Video 2	<p>Connect to the video jack 2, and the audio jacks 2. If you connect mono equipment, connect to the L(MONO) jack .</p>
C	<p>Connect to the jack to listen to sound from the TV on headphones.</p>
D 1 or 1 or 3, and 1 or 3 Video 1 or Video 1 or Video 3	<p>Connect to the S video jack 1 or the video jack 1 or 3, and the audio jacks 1 or 3. To avoid picture noise, do not connect the camcorder to the video jack 1 and the S video jack 1 at the same time. If you connect mono equipment, connect to the L(MONO) jack 1 or 3.</p>
E /	<p>Connect to the video output jack to record the image from the TV. Connect to the audio output jacks to record the sound from the TV on DVD recorder or VCR. To turn off the sound of the TV speakers, set “Speaker” to “Audio System” (page 27). If you connect mono equipment, connect to the L jack .</p> <ul style="list-style-type: none"> • The monitor output jacks cannot support HD/DVD, HDMI and PC signals source pictures, also digital audio signal for sound.
F /1 or 2 HD/DVD 1 or HD/DVD 2	<p>Connect to the component jacks and the audio jacks /1 or 2. For better picture quality, component connection is recommended if your DVD player has a component video output.</p>
G	<p>Connect to the audio output jacks to listen to the sound from the TV on Hi-Fi audio equipment. To turn off the sound of the TV speakers, set “Speaker” to “Audio System” (page 27).</p>
H PC IN (RGB)/ PC	<p>Connect to the PC IN (RGB) jack and the audio jack . It is recommended to use a PC cable with ferrite.</p>

Viewing Twin Picture

You can view two pictures (external input and TV programme) on the screen simultaneously. Connect the optional equipment (page 15), and make sure that images from the equipment appear on the screen (page 16).

1 Press .

Two pictures are displayed simultaneously.



Twin Picture Availability







In Left Window	In Right Window
HD/DVD 1	
HD/DVD 2	TV programme
HDMI 1 (except PC input mode)	
HDMI 2 (except PC input mode)	
HDMI 3 (except PC input mode)	
Video 1 or S Video 1	
Video 2	No picture
Video 3	

2 Press to select active picture.

3 Press number buttons or PROG +/- to select the TV channel.

To return to single picture mode

Press  or RETURN.

-  • This function is not available for a PC input source.
- You cannot change the size of the pictures.
- The picture and sound from the monitor output jacks  (refer  in page 15) will follow the left picture (Video 1/S Video 1/Video 2/Video 3 only). However, if audio output jacks  (refer  in page 15) are connected, the sound will follow TV speaker.
- In Twin Picture mode, as picture size reduced, this may decrease picture smoothness.
-  • The picture framed in grey is audible. You can switch the audible picture by pressing .
- You can also use the Twin Picture feature by selecting "Twin Picture" from the Tools menu.

Viewing PIP (Picture in Picture)

You can view two pictures (PC input and TV programme) on the screen simultaneously. Connect a PC (page 15), and make sure that images from a PC appear on the screen (page 16).

1 Press .

Two pictures are displayed simultaneously.







PIP Availability

In Main Window	In Sub Window
PC	
HDMI 1 (in PC input mode only)	TV programme
HDMI 2 (in PC input mode only)	
HDMI 3 (in PC input mode only)	

2 Press number buttons or PROG +/- to select the TV channel.

To return to single picture mode

Press RETURN.

-  • You cannot display resolutions higher than WXGA (1360 × 768 pixels).
- "Power Management" is not available in PIP mode (page 29).
- The sound will follow TV speaker when audio output jacks  (refer  in page 15) are connected.
- In PIP mode, as picture size reduced, this may decrease picture smoothness.
-  • You can switch the audible picture by selecting "Audio Swap" from the Tools menu.
- You can also use the PIP feature by selecting "PIP" from the Tools menu.



Using BRAVIA Sync (Control for HDMI)

The control for HDMI function enables the TV to communicate with the connected equipment that is compatible with the function, using HDMI CEC (Consumer Electronics Control).

For example, by connecting Sony equipment that is compatible with control for HDMI (with HDMI cables), you can control them together.

Be sure to connect the compatible equipment correctly, and make the necessary settings.













To connect the equipment that is compatible with control for HDMI

Connect the compatible equipment and the TV with an HDMI cable. When connecting an audio system, in addition to the HDMI cable, be sure to also connect to the audio output jacks  (refer  in page 15) to listen to the sound from the TV on audio system. For details, see page 15.

To make the control for HDMI settings

The control for HDMI settings must be set on both the TV side and the connected equipment side. See “HDMI Set-up” on page 27 for the TV side settings. See the operating instructions of the connected equipment for setting details.

Control for HDMI

- Automatically turns the connected equipment off when you turn the TV off.
- Automatically turns the TV on and switches the input to the connected equipment when the equipment starts to play.
- If you turn on a connected audio system while the TV is on, the sound output switches from the TV speaker to the audio system.
- Adjusts the volume () and mutes the sound () of a connected audio system.
- You can operate the connected Sony equipment that has the BRAVIA Sync logo by the TV remote by pressing:
 - //// to operate the connected equipment directly.
 - SYNC MENU to display the menu of the connected HDMI CEC equipment which is supported on the screen.
After displaying the menu, you can operate the menu screen by using /// and .
 - TOOLS to display “Device Control”, then select options from “Menu”, “Options”, and “Content List” to operate the equipment.

Refer to the instruction manual of the equipment for available control.

Navigating through menus

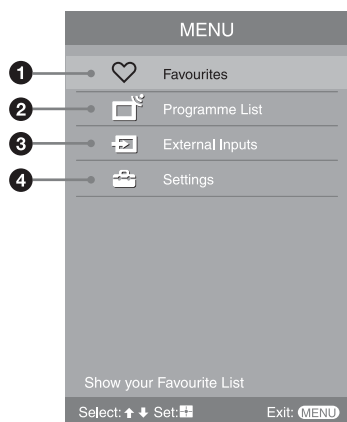
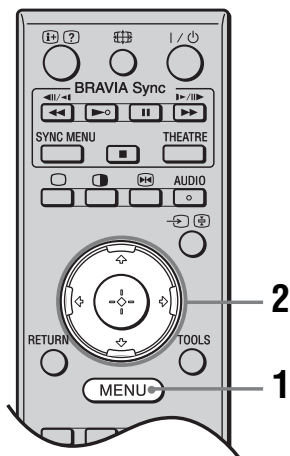

“MENU” allows you to enjoy various convenient features of this TV. You can easily select channels or inputs sources and change the settings for your TV.

- 1 Press MENU.
- 2 Press \uparrow/\downarrow to select an option, then press \oplus .

To exit the menu, press MENU.

1 Favourites

- Displays the favourite list (page 20).
- To watch the desired channel, select the favourite channel number, then press \oplus .
 - To add the current channel to the favourite list, select “Add to Favourites”. When the favourite list is full, select “Edit Favourites” to remove any channel from your list and try again (page 20).

2 Programme List

- Displays available TV channels.
- To watch the desired channel, select the channel, then press \oplus .
 - To assign a label to a channel, select “Edit Programme Labels”, then see page 30.

3 External Inputs

- Selects equipment connected to your TV.
- To watch the desired external input, select the input source, then press \oplus .
 - To assign a label to an external input, select “Edit Video Labels”, then see page 26.
 - To select the equipment that is compatible with control for HDMI, select “HDMI Device Selection”.

4 Settings

- Displays the “Settings” menu where most of the advanced settings and adjustments are performed. For details about settings, see page 21 to 22.

Using the Favourite List

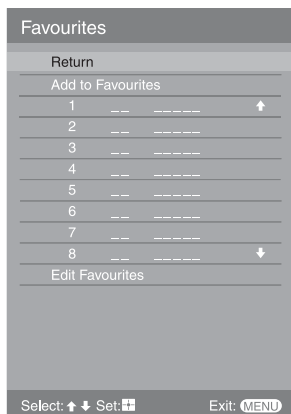

Favourite List

The Favourite feature lets you select programmes from a list of up to 16 favourite channels that you specify.

- 1** Press MENU.
- 2** Press \uparrow/\downarrow to select “Favourites”, then press \oplus .
- 3** Perform the desired operation as shown in the following table or displayed on the screen.

To	Do this
Watch a channel	Press \uparrow/\downarrow to select the channel number, then press \oplus .
Turn off the Favourite list	Press RETURN to return to the previous screen. Press MENU or \heartsuit to exit the menu.
Add a current channel to the Favourite list	Press \uparrow/\downarrow to select “Add to Favourites”, then press \oplus .
Remove a channel from the Favourite list	Press \uparrow/\downarrow to select “Edit Favourites”, then press \oplus . The “Favourite Set-up” screen appears. For details, see “Favourite Set-up” on page 30.

Settings adjustment

You are able to change the settings of your TV from “Settings” menu.

- 1 Press MENU. Press \uparrow/\downarrow to select “Settings”, then press \oplus .
- 2 Press \uparrow/\downarrow to select a menu icon, then press \oplus .
- 3 Press $\uparrow/\downarrow/\leftarrow/\rightarrow$ to select an option or adjust a setting, then press \oplus .

The following is an overview of the items that can be adjusted.

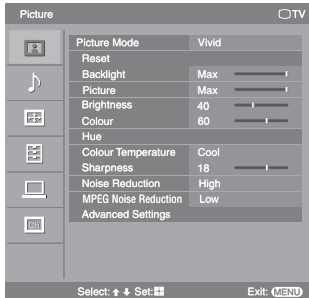

Picture menu (page 23)

“Picture Mode”: “Vivid” → “Standard” → “Cinema” (except PC input mode)

“Display Mode”: “Video” → “Text” (in PC input mode only)

“Reset”

“Backlight”

“Picture”

“Brightness”

“Colour”

“Hue”

“Colour Temperature”: “Cool” → “Neutral” → “Warm 1” → “Warm 2”

“Sharpness”

“Noise Reduction”: “High” → “Medium” → “Low” → “Off”

“MPEG Noise Reduction”: “High” → “Medium” → “Low” → “Off”

“Advanced Settings”: “Adv. Contrast Enhancer”, “Live Colour”

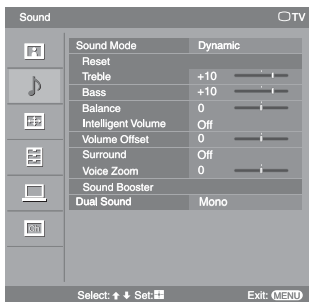

Sound menu (page 24)

“Sound Mode”: “Dynamic” → “Standard” → “Clear Voice”

“Reset”

“Treble”

“Bass”

“Balance”

“Intelligent Volume”: “On” → “Off”

“Volume Offset”

“Surround”: “S-FORCE Front Surround” → “Simulated Stereo” → “Off”

“Voice Zoom”

“Sound Booster”: “High” → “Low” → “Off”

“Dual Sound”

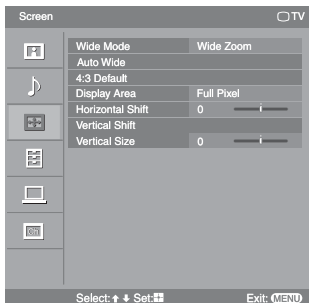

Screen menu (page 25)

“Wide Mode”: “Wide Zoom” → “Normal” → “Full” → “Zoom”

“Auto Wide”: “On” → “Off”

“4:3 Default”: “Wide Zoom” → “Normal” → “Off”

“Display Area”: “Full Pixel” → “Normal” (KLV-40S400A only)

“Horizontal Shift”

“Vertical Shift”

“Vertical Size”

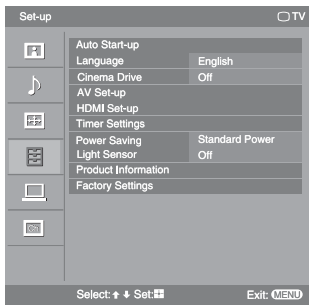

Set-up menu (page 26)

“Auto Start-up”

“Language”: “English” → “中文” (Chinese) → “ภาษาไทย” (Thai) → “عربي” (Arabic) → “فارسی” (Persian)

“Cinema Drive”: “Auto” → “Off”

“AV Set-up”: “Video Labels”, “Auto S Video”, “Speaker”, “Audio Out”, “Colour System”

“HDMI Set-up”: “Control for HDMI”, “Auto Devices Off”, “Auto TV On”, “Device List Update”, “HDMI Device List”

“Timer Settings”: “Sleep Timer”, “On Timer”, “Clock Set”

“Power Saving”: “Standard Power” → “Reduced Power” → “Picture Off”

“Light Sensor”: “On” → “Off”

“Product Information”

“Factory Settings”

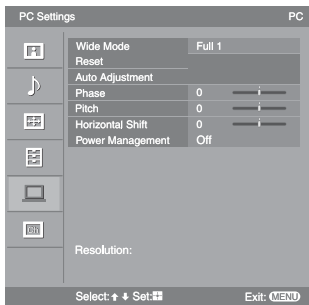

PC Settings menu (page 28)

“Wide Mode”: “Full 1” → “Full 2”

“Reset”

“Auto Adjustment”

“Phase”

“Pitch”

“Horizontal Shift”

“Power Management”: “On” → “Off”

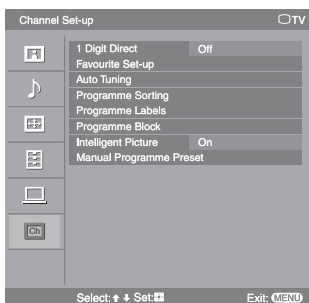

Channel Set-up menu (page 30)

“1 Digit Direct”: “On” → “Off”

“Favourite Set-up”

“Auto Tuning”

“Programme Sorting”

“Programme Labels”

“Programme Block”

“Intelligent Picture”: “On with Indicator” → “On” → “Off”







“Manual Programme Preset”: “Programme”, “TV System”, “VHF Low”/ “VHF High”/ “UHF”, “Label”, “AFT”, “Audio Filter”, “Skip”, “Colour System”, “Signal Booster”, “Signal Level”

- The options you can adjust vary depending on the situation. Unavailable options are greyed out or not displayed.







Picture menu

Press MENU and select “Settings”. Make sure the “Picture” icon () is selected, then press ⊕.

Picture Mode	Selects the picture mode except for PC input source. “Vivid” : For enhanced picture contrast and sharpness. “Standard” : For standard picture. Recommended for home entertainment. “Cinema” : For optimum picture quality of film videos.
Display Mode	Selects the display mode for PC input source. “Video” : For video images. “Text” : For text, charts or tables.  • The options displayed vary depending on the input source.
Reset	Resets all the “Picture” settings except “Picture Mode” and “Display Mode” to the factory settings.
Backlight	Adjusts the brightness of the backlight.
Picture	Increases or decreases picture contrast.
Brightness	Brightens or darkens the picture.
Colour	Increases or decreases colour intensity.
Hue	Increases or decreases the green tones and red tones.  • “Hue” can only be adjusted for an NTSC colour system (e.g. U.S.A. video tapes).  • “Hue” is not available for PC input, component and HDMI input source.
Colour Temperature	Adjusts the whiteness of the picture. “Cool” : Gives the white colours a blue tint. “Neutral” : Gives the white colours a neutral tint. “Warm 1”/“Warm 2” : Gives the white colours a red tint. “Warm 2” gives a redder tint than “Warm 1”.  • “Warm 1” and “Warm 2” are not available when “Picture Mode” is set to “Vivid”.
Sharpness	Sharpens or softens the picture.
Noise Reduction	Reduces the picture noise (snowy picture) in a weak broadcast signal. “High”/“Medium”/“Low” : Modifies the effect of the noise reduction. “Off” : Turns off the “Noise Reduction” feature.
MPEG Noise Reduction	Reduces the picture noise in MPEG-compressed video. Choose either “High”, “Medium”, “Low” or “Off”.  • “MPEG Noise Reduction” is not available for a PC input and component input source.
Advanced Settings	Customises the “Picture” function in more detail. When you set “Picture Mode” to “Standard” or “Cinema”, you can set/change these settings. “Adv. Contrast Enhancer” : Automatically adjusts “Backlight” and “Picture” to the most suitable settings judging from the brightness of the screen. This setting is especially effective for dark images scenes. It will increase the contrast distinction of the darker picture scenes. “Live Colour” : Makes colours more vivid.  • “Advanced Settings” is not available for a PC input source or when “Picture Mode” is set to “Vivid”.

Sound menu

Press MENU and select “Settings”. Press  to select the “Sound” icon (), then press .

Sound Mode	“ Dynamic ”: Enhances treble and bass. Recommended for home entertainment. “ Standard ”: For standard sound. “ Clear Voice ”: Makes voice sound clearer.
Reset	Resets all the “Sound” settings except “Sound Mode” and “Dual Sound” to the factory settings.
Treble	Adjusts higher-pitched sounds.
Bass	Adjusts lower-pitched sounds.
Balance	Emphasises left or right speaker balance.
Intelligent Volume	Keeps a constant volume level even when volume level gaps occur (e.g. adverts tend to be louder than programmes).
Volume Offset	Adjusts the volume level of the current input relative to other inputs.
Surround	“ S-FORCE Front Surround ”: Available for normal stereo broadcast and 5.1ch broadcast surround audio, and the audio input from connected equipment. “ Simulated Stereo ”: Adds a surround-like effect to mono programmes. “ Off ”: Converts and reproduces 5.1ch and other broadcast surround audio as normal stereo audio (2ch). Reproduces the original audio of other broadcasts as it is.
Voice Zoom	Adjusts the clarity of human voices. For example, if the voice of a news announcer is indistinct, you can turn up this setting to make the voice clearer. Conversely, if you are watching a sports programme, you can turn down this setting to soften the voice of the commentator.
Sound Booster	Gives sound more impact by compensating for phase effects in speakers. Choose either “High”, “Low” or “Off”.  • “Sound Booster” is available when “Sound Mode” is set to “Standard”.

Dual Sound

Selects the sound from the speaker for a stereo or bilingual broadcast. The selection varies, depending on the Broadcasting.

Broadcasting	Selection
NICAM stereo	Stereo (stereo sound) Mono (regular sound)
NICAM bilingual	Main (main sound) Sub (sub sound) Mono (regular sound)
NICAM monaural	Main (main sound) Mono (regular sound)
A2 (German) stereo	Stereo (stereo sound) Mono (regular sound)
A2 (German) bilingual	Main (main sound) Sub (sub sound)

- 🔊 • If the signal is very weak, the sound becomes monaural automatically.
- If the stereo sound is noisy when receiving a NICAM programme, select “Mono”. The sound becomes monaural, but the noise is reduced.
- The “Dual Sound” setting is memorized for each programme position.
- You cannot receive a stereo broadcast signal when “Mono” is selected for the programme position.
- You cannot receive stereo or dual sound when “Low” or “High” is selected in “Audio Filter” (page 31).
- 📍 • NICAM is receivable in following countries/regions. Hong Kong, Singapore, New Zealand, Malaysia, Thailand, etc.
- A2 (German) is receivable in following countries/regions. Australia, Malaysia, Thailand, etc.
- If you select other equipment connected to the TV, set “Dual Sound” to “Stereo”, “Main” or “Sub”. However, when the external equipment connected to the HDMI jack is selected, this is fixed to “Stereo”, except HDMI IN 3 with DVI analogue sound input.



Screen menu

Press MENU and select “Settings”. Press \uparrow/\downarrow to select the “Screen” icon () , then press \oplus .

- 🔊 • “Screen” menu is not available when receiving PC signal. When receiving PC signal, you can use “PC Settings” menu to perform related settings (page 28).

Wide Mode

For details about the wide mode, see page 12.

Auto Wide

Automatically changes the wide mode according to the input signal from an external equipment. To keep your setting, select “Off”.

- 🔊 • “Auto Wide” is not available when watching TV programmes.
- 📍 • Even if “Auto Wide” is set to “On” or “Off”, you can always modify the format of the screen by pressing  repeatedly.

4:3 Default

Selects the default screen mode for use with 4:3 broadcasts.

“Wide Zoom”: Displays conventional 4:3 broadcasts with an imitation wide screen effect.

“Normal”: Displays conventional 4:3 broadcasts in the correct proportions.



“Off”: Keeps the current “Wide Mode” setting when the channel or input is changed.

- 🔊 • “4:3 Default” is available only if “Auto Wide” is set to “On”.
- “4:3 Default” is not available when watching TV programmes or for a HD input signal.

Continued

Display Area (KLV-40S400A only)	Adjusts the screen area for displaying the picture. “Full Pixel” : Displays the picture for 1080/50i, 1080/60i, 1080/50p and 1080/60p sources (HDMI or component input only) or 1080/24p sources (HDMI input only) in the original size when parts of the picture are cut off. “Normal” : Displays the recommended picture area.  • “Display Area” is available only when “Wide Mode” is set to “Full”.
Horizontal Shift	Adjusts the horizontal position of the picture.
Vertical Shift	Adjusts the vertical position of the picture when “Wide Mode” is set to “Wide Zoom” or “Zoom”.
Vertical Size	Adjusts the vertical size of the picture when “Wide Mode” is set to “Wide Zoom” or “Zoom”.

Set-up menu

Press MENU and select “Settings”. Press  to select the “Set-up” icon (), then press .

Auto Start-up	Starts the initial set-up procedure. Usually, you do not need to do this operation because it was done when the TV was first installed (page 6). However, this option allows you to repeat the process (e.g. to retune the TV after moving house, or to search for new channels that have been launched by broadcasters).
Language	Selects the language in which the menus are displayed.
Cinema Drive	Provides smoother picture movement when playing DVD or VCR images taken on film, reducing picture blur and graininess. “Auto” : Provides smoother picture movement than the original film video. Use this setting for standard use. “Off” : Turns off the “Cinema Drive” feature.  • If the image contains irregular signals or too much noise, “Cinema Drive” will be automatically turned off even if “Auto” is selected. • “Cinema Drive” is not available for a PC input source.

AV Set-up

Video Labels

Assigns a name to any equipment connected to the side and rear jacks. The name will be displayed briefly on the screen when the equipment is selected. You can skip input signals from connected equipment that you do not want displayed on the screen.

1 Press  to select the desired input source, then press .



2 Press  to select the desired option below, then press .

Equipment labels: Uses one of the preset labels to assign a name to connected equipment.

“Edit:”: Creates your own label. Follow steps 2 to 4 of “Programme Labels” (page 30).

“Skip”: Skips an unnecessary input source.

Auto S Video

Selects the input signal from S video jack  1 when  /  1 jacks are both connected.

“On”: Switches automatically between the S video jack and the composite video jacks depending on the cable connection.

“Off”: Activates the composite video jacks.

Speaker

Turns on/off the TV's internal speakers.

“TV Speaker”: The TV speakers are turned on in order to listen to the TV's sound through the TV speakers.

“Audio System”: The TV speakers are turned off in order to listen to the TV's sound only through your external audio equipment connected to the audio output jacks.

You can also turn on the connected equipment that is compatible with control for HDMI, after making the appropriate settings of control for HDMI.

- All items in “Sound” menu except “Dual Sound” are not available when “Speaker” is set to “Audio System”.

Audio Out

“Variable”: The audio output from your audio system can be controlled by the TV's remote.

“Fixed”: The audio output of the TV is fixed. Use your audio receiver's volume control to adjust the volume (and other audio settings) through your audio system.

- “Audio Out” is not available for audio system connected to the TV using the HDMI jacks.

Colour System

Selects the colour system (“Auto”, “PAL”, “SECAM”, “NTSC3.58”, “NTSC4.43” or “PAL60”) according to the composite video signal from the input source.

HDMI Set-up

Allows the TV to communicate with equipment that is compatible with the control for HDMI function, and connected to the HDMI jacks of the TV. Note that communication settings must also be made on the connected equipment.

Control for HDMI

Sets whether or not to link the operations of the TV and the connected equipment that is compatible with control for HDMI. When set to “On”, the following menu items can be performed.

If the specific Sony equipment that is compatible with control for HDMI is connected, this setting is applied to the connected equipment automatically when the “Control for HDMI” is set to “On” using the TV.

Auto Devices Off

When this is set to “On”, the connected equipment that is compatible with control for HDMI turns off when you turn off the TV.

Auto TV On

When this is set to “On”, the TV turns on when you turn on the connected equipment that is compatible with control for HDMI.

Device List Update





Creates or updates the “HDMI Device List”. Up to 11 compatible equipment items can be connected, and up to 5 equipment items can be connected to a single jack. Be sure to update the “HDMI Device List” when you change the connections or settings.

If the specific Sony equipment that is compatible with control for HDMI is connected, this setting is applied to the connected equipment automatically when the “Device List Update” is executed on the TV.



HDMI Device List

Displays a list of connected equipment that is compatible with control for HDMI.

- You cannot use “Control for HDMI” and “Device List Update” if the TV operations are linked to the operations of an audio system that is compatible with control for HDMI.

Timer Settings	<p>Sets the timer to turn on/off the TV.</p> <p>Sleep Timer Sets a period of time after which the TV automatically switches itself into standby mode. When the “Sleep Timer” is activated, the  (Timer) indicator on the TV front panel lights up in amber.</p> <ul style="list-style-type: none">  If you turn off the TV and turn it on again, “Sleep Timer” is reset to “Off”. A notification message appears on the screen one minute before the TV switches to standby mode. <p>On Timer Sets the timer to turn on the TV from standby mode. “Day”: Selects the day on which you want to activate the “On Timer”. “Time”: Sets the time to turn on the TV. “Duration”: Selects the time period after which the TV automatically switches to standby mode again.</p> <p>Clock Set Allows you to adjust the clock manually.</p>
Power Saving	<p>Selects the power saving mode to reduce the power consumption of the TV. Choose either “Standard Power”, “Reduced Power” or “Picture Off”. When “Picture Off” is selected, the picture is turned off and the  (Picture Off) indicator on the TV front panel lights up in green. The sound remains unchanged.</p>
Light Sensor	<p>“On”: Automatically optimises the picture settings according to the ambient light in the room. “Off”: Turns off the “Light Sensor” feature.</p> <ul style="list-style-type: none">  Be sure not to put anything over the sensor, as its function may be affected.
Product Information	<p>Displays your TV’s product information.</p>
Factory Settings	<p>Resets all settings to factory settings other than “Programme Block”, “Favourites” settings, and the programme preset data. After completing this process, the initial set-up screen is displayed the next time you turn on the TV. Completing auto tuning in initial set-up will reset these settings. To keep them, select “Cancel” in the auto tuning confirmation dialog.</p> <ul style="list-style-type: none">  Be sure not to turn the TV off during this period (it takes about 30 seconds) or press any buttons.

PC Settings menu

Press MENU and select “Settings”. Press  to select the “PC Settings” icon (), then press .

Wide Mode	<p>Selects a screen mode for displaying input from your PC, see page 13. “Full 1”: Enlarges the picture to fill the display area, keeping its original horizontal-to-vertical aspect ratio. “Full 2”: Enlarges the picture to fill the display area.</p>
Reset	<p>Resets all the “PC Settings” except “Wide Mode” and “Power Management” to the factory settings.</p>
Auto Adjustment	<p>Automatically adjusts the display position and phase of the picture when the TV receives an input signal from the connected PC.</p> <ul style="list-style-type: none">  “Auto Adjustment” may not work well with certain input signals. In such cases, manually adjust “Phase” and “Horizontal Shift”.

Phase	Adjusts the phase when the screen flickers.
Pitch	Adjusts the pitch when the picture has unwanted vertical stripes.
Horizontal Shift	Adjusts the horizontal position of the picture.
Power Management	Switches the TV to standby mode if no signal is received for 30 seconds.

PC Input Signal Reference Chart for supported signals and “Resolution:” value displayed

Signals	Horizontal (Pixel)	Vertical (Line)	Horizontal frequency (kHz)	Vertical frequency (Hz)	Standard
VGA	640	480	31.5	60	VGA
	640	480	37.5	75	VESA
	720	400	31.5	70	VGA-T
SVGA	800	600	37.9	60	VESA Guidelines
	800	600	46.9	75	VESA
XGA	1024	768	48.4	60	VESA Guidelines
	1024	768	56.5	70	VESA
	1024	768	60	75	VESA
WXGA	1280	768	47.4	60	VESA
	1280	768	47.8	60	VESA
	1360	768	47.7	60	VESA

- 🔊 • This TV’s PC input does not support Sync on Green or Composite Sync.
- This TV’s PC input does not support interlaced signals.
- If input signal is not shown in above chart, then this signal may not be displayed properly or cannot be displayed according to your settings.
- When connecting a personal computer to HDMI IN 1, 2 or 3 jack, your TV can only display the signals (boldfaced) in the above chart with a 60 Hz vertical frequency.
- 💡 • For the best picture quality, it is recommended to use the signals (boldfaced) in the above chart with a 60 Hz vertical frequency from a personal computer. In plug and play, signals with a 60 Hz vertical frequency will be selected automatically.

Channel Set-up menu

Press MENU and select "Settings". Press \uparrow/\downarrow to select the "Channel Set-up" icon (), then press \oplus .

1 Digit Direct	<p>When "1 Digit Direct" is set to "On", you can select a channel using one preset number button (0 - 9) on the remote.</p> <p> • When "1 Digit Direct" is set to "On", you cannot select channel numbers 10 and above entering two digits using the remote.</p>
Favourite Set-up	<p>Allows you to set your favourite channels by assigning the desired channel numbers.</p> <ol style="list-style-type: none">1 Press \uparrow/\downarrow to select your favourite channel number, then press \oplus.2 Press \uparrow/\downarrow to select your desired channel, then press \oplus. <p>To reset the Favourite channels</p> <p>Select "_ _", then press \oplus.</p> <p>Repeat the procedure above to set other favourite channels.</p>
Auto Tuning	<p>Tunes in all the available channels.</p> <p>This option allows you to retune the TV after moving house, or to search for new channels that have been launched by broadcasters.</p>
Programme Sorting	<p>Changes the order in which the channels are stored on the TV.</p> <ol style="list-style-type: none">1 Press \uparrow/\downarrow to select the channel you want to move to a new position, then press \oplus.2 Press \uparrow/\downarrow to select the new position for your channel, then press \oplus.
Programme Labels	<p>Assigns a channel name of your choice up to five letters or numbers. The name will be displayed briefly on the screen when the channel is selected.</p> <ol style="list-style-type: none">1 Press \uparrow/\downarrow to select the channel you want to name, then press \oplus.2 Press \uparrow/\downarrow to select the desired letter or number ("_" for a blank space), then press \rightarrow. <p>If you input a wrong character</p> <p>Press \leftarrow/\rightarrow to select the wrong character. Then, press \uparrow/\downarrow to select the correct character.</p> <p>To delete all the characters</p> <p>Select "Reset", then press \oplus.</p> <ol style="list-style-type: none">3 Repeat the procedure in step 2 until the name is completed.4 Select "OK", then press \oplus.
Programme Block	<p>Blocks an individual channel from being watched.</p> <ol style="list-style-type: none">1 Press \uparrow/\downarrow to select the channel you want to block, then press \oplus.2 Press \uparrow/\downarrow to select "Block", then press \oplus. <p>To watch the channel, select "Allow".</p>
Intelligent Picture	<p>"On with Indicator": Automatically reduces the picture noise. The signal level bar is displayed when the channel is changed or the display is changed from an input screen to a TV programme.</p> <p>"On": Automatically reduces the picture noise.</p> <p>"Off": Turns off the "Intelligent Picture" feature.</p>

Manual Programme Preset

Before selecting “Label”/“AFT”/“Audio Filter”/“Skip”/“Colour System”/“Signal Booster”, press PROG +/- to select the programme number with the channel. You cannot select a programme number that is set to “Skip” (page 31).

Programme/TV System/VHF or UHF

Presets programme channels manually.

- 1 Select “Programme”, then press ⊕.
- 2 Press ⬆/⬇ to select the programme number you want to manually tune (if tuning a VCR, select channel 00), then press RETURN.
- 3 Press ⬆/⬇ to select “TV System”, then press ⊕.
- 4 Press ⬆/⬇ to select your TV broadcast systems, then press ⊕.
- 5 Press ⬆/⬇ to go to the frequency range indication (“VHF Low”, “VHF High” or “UHF”), then press ⊕.
- 6 Tune the channels as follows:
Press ⬅/➡ to search for the next available channel. When a channel has been found, the search will stop. To continue searching, press ⬅/➡.

Repeat the procedure above to preset other channels manually.

Label

Assigns a name of your choice, up to five letters or numbers, to the selected channel. This name will be displayed briefly on the screen when the channel is selected.

To input characters:

- 1 Press ⬆/⬇ to select the desired letter or number (“_” for a blank space), then press ➡.

If you input a wrong character

Press ⬅/➡ to select the wrong character. Then, press ⬆/⬇ to select the correct character.

- 2 Repeat the procedure in step 1 until the name is completed, then press ⊕.

AFT

Allows you to fine-tune the selected programme number manually if you feel that a slight tuning adjustment will improve the picture quality.

You can adjust the fine tuning over a range of -15 to +15. When “On” is selected, the fine tuning is performed automatically.

Audio Filter

Improves the sound for individual channels in the case of distortion in mono broadcasts. Sometimes a non-standard broadcast signal can cause sound distortion or intermittent sound muting when watching mono programmes.

If you do not experience any sound distortion, we recommend that you leave this option set to the factory setting “Off”.

🔊 • You cannot receive stereo or dual sound when “Low” or “High” is selected.

Skip

Skips unused channels when you press PROG +/- to select channels. (You can still select a skipped channel using the number buttons.)

Colour System

Selects the colour system (“Auto”, “PAL”, “SECAM”, “NTSC3.58”, “NTSC4.43” or “PAL60”) according to the channel.

Signal Booster (Intelligent Signal Booster)

Improves the picture quality if the TV signal is too strong or weak.

Press ⬆/⬇ to select either “Off” if the signal is too strong (picture distorted; picture with lines; signal interference) or “Auto” if the signal is weak (snowy picture), then press ⊕.





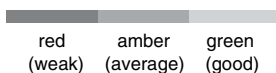





Signal Level

Displays the signal level for programme currently being watched.



Additional Information

Specifications

Model name	KLV-40S400A	KLV-37S400A	KLV-32S400A	KLV-26S400A	
System					
Panel System	LCD (Liquid Crystal Display) Panel				
TV System	B/G, I, D/K, M				
Colour System	PAL, PAL60, SECAM, NTSC4.43, NTSC3.58				
Channel Coverage	B/G: VHF: E2 to E12/ UHF: E21 to E69/ CATV: S01 to S03, S1 to S41 VHF: 0 to 12, 5A, 9A/ UHF: 28 to 69/ CATV: S01 to S03, S1 to S44 (Australia only) VHF: 1 to 11/ UHF: 21 to 69/ CATV: S01 to S03, S1 to S41 (New Zealand only) I: UHF: B21 to B69/ CATV: S01 to S03, S1 to S41 D/K: VHF: C1 to C12, R1 to R12/ UHF: C13 to C57, R21 to R60/ CATV: S01 to S03, S1 to S41, Z1 to Z39 M: VHF: A2 to A13/ UHF: A14 to A79/ CATV: A-8 to A-2, A to W+4, W+6 to W+84				
Sound Output	10 W + 10 W				
Input/Output jacks					
Antenna	75 ohm external terminal				
 1	S video input (4-pin mini DIN)				
 1, 2, 3	Video input (phono jack)				
 1, 2, 3	Audio input (phono jacks): 500 mVrms, Impedance: 47 kilohms				
 1, 2	Supported formats: 1080p (50/60 Hz), 1080i (50/60 Hz), 720p (50/60 Hz), 576p, 576i, 480p, 480i Y: 1 Vp-p, 75 ohms, 0.3V sync negative/Pb/Cb: 0.7 Vp-p, 75 ohms/Pb/Cr: 0.7 Vp-p, 75 ohms				
 1, 2	Audio input (phono jacks): 500 mVrms, Impedance: 47 kilohms				
	Video output (phono jack)				
	Audio output (phono jacks)				
HDMI IN 1, 2, 3	Video: 1080/24p, 1080p (50/60 Hz), 1080i (50/60 Hz), 720p (50/60 Hz), 576p, 576i, 480p, 480i Audio: Two channel linear PCM 32, 44.1 and 48 kHz, 16, 20 and 24 bits Analogue audio input (minijack): 500 mVrms, Impedance: 47 kilohms (HDMI IN 3 only)				
PC IN  (RGB)	PC Input (D-sub 15-pin) (see page 29) G: 0.7 Vp-p, 75 ohms, non Sync on Green/B: 0.7 Vp-p, 75 ohms/ R: 0.7 Vp-p, 75 ohms/HD: 1-5 Vp-p/VD: 1-5 Vp-p				
PC IN 	PC audio input (minijack)				
	Audio output (phono jacks)				
	Headphones jack				
Power and others					
Power Requirements	110–240 V AC, 50/60 Hz 220-240 V AC, 50/60 Hz (New Zealand only)				
Screen Size (inches)	40	37	32	26	
Display Resolution	1,920 pixels (horizontal) × 1,080 lines (vertical)	1,366 pixels (horizontal) × 768 lines (vertical)			
Power Consumption	Indicated on the rear of the TV.				
Dimensions (w × h × d)*	with stand (mm)	997 × 691 × 279	931 × 656 × 279	809 × 584 × 242	675 × 511 × 242
	without stand (mm)	997 × 644 × 110	931 × 609 × 110	809 × 542 × 99	675 × 466 × 97
Mass*	with stand (kg)	22	21	17	13
	without stand (kg)	19	18	14	10
Optional Accessories	Wall-Mount bracket	SU-WL500 and SU-WL50B		SU-WL100	
	TV stand	SU-FL300M			

* Dimensions and mass are approximate values.

Design and specifications are subject to change without notice.



Troubleshooting

If you find any problem while viewing your TV, you can either check the Troubleshooting guide below or use the “Factory Settings” function (page 28). If the problem persists, contact your Sony dealer.

Check whether the  (standby) indicator is flashing in red.







When it is flashing



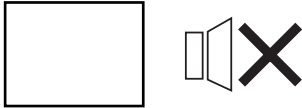



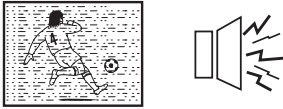
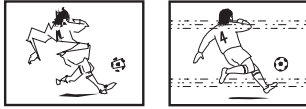

The self-diagnosis function is activated.

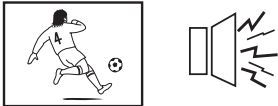
- 1 Count how many  (standby) indicator flashes between each two second break.
For example, the indicator flashes three times, then there is a two second break, followed by another three flashes, etc.
- 2 Press  on the top edge of the TV to turn it off, disconnect the AC power cord, and inform your dealer or Sony service centre of how the indicator flashes (number of flashes).

When it is not flashing

- 1 Check the items listed below.
- 2 If the problem still persists, have your TV serviced by qualified service personnel.

Problem	Cause/Remedy
No Picture	
<p>No picture (screen is dark) and no sound</p> 	<ul style="list-style-type: none"> • Check the antenna/cable connection. • Connect the TV to the AC power outlet, and press  on the top edge of the TV. • If the  (standby) indicator lights up in red, press .
<p>No picture or no menu information from equipment connected to the video input jack</p>	<ul style="list-style-type: none"> • Press / to display the connected equipment list, then select the desired input. • Check the connection between the optional equipment and the TV.
Poor Picture	
<p>Only snow and noise appear on the screen</p> 	<ul style="list-style-type: none"> • Check if the antenna is broken or bent. • Check if the antenna has reached the end of its serviceable life (three to five years in normal use, one to two years at the seaside).
<p>Distorted picture (dotted lines or stripes)</p> 	<ul style="list-style-type: none"> • Keep the TV away from electrical noise sources such as cars, motorcycles, hair-dryers or optional equipment. • When installing optional equipment, leave some space between the optional equipment and the TV. • Check the antenna/cable connection. • Keep the antenna cable away from other connecting cables. • Broadcast signals are too strong. Set the “Signal Booster” to “Off” (page 31) or turn off or disconnect the booster if it is in use.
<p>Picture or sound noise when viewing a TV channel</p>	<ul style="list-style-type: none"> • Select “Manual Programme Preset” in the “Channel Set-up” menu and adjust “AFT” (Automatic Fine Tuning) to obtain better picture reception (page 31). • Select “Noise Reduction” in the “Picture” menu to reduce the noise in the picture (page 23).

Problem	Cause/Remedy
<p>Good picture, but noisy sound</p> 	<ul style="list-style-type: none"> • The TV system setting is inappropriate. • If the sound of all the channels are noisy, perform “Auto Tuning” in the “Channel Set-up” menu to preset the channel again (page 30). • If the sound of some channels is noisy, select the channel, then perform “Manual Programme Preset” in the “Channel Set-up” menu, and select the appropriate TV system (“TV System”) (page 31).
<p>Some tiny black points and/or bright points appear on the screen</p>	<ul style="list-style-type: none"> • The picture of a display unit is composed of pixels. Tiny black points and/or bright points (pixels) on the screen do not indicate a malfunction.
<p>No colour on programmes</p> 	<ul style="list-style-type: none"> • Select “Reset” in the “Picture” menu to return to the factory settings (page 23).
<p>No colour or irregular colour when viewing a signal from the Y, Pb/Cb, Pr/Cr jacks of  1 or 2</p>	<ul style="list-style-type: none"> • Check the connection of the Y, Pb/Cb, Pr/Cr jacks of  1 or 2. • Make sure that the Y, Pb/Cb, Pr/Cr jacks of  1 or 2 are firmly seated in their respective jacks.
<p>Picture flashes initially when changing to HDMI mode or switching on the TV with HDMI mode</p>	<ul style="list-style-type: none"> • This is probably caused by the authentication process between HDMI equipment and the TV. It does not indicate a malfunction.
Sound	
<p>No sound, but good picture</p> 	<ul style="list-style-type: none"> • Press  +/- or  (Mute). • Check if the “Speaker” is set to “TV Speaker” from the “AV Set-up” menu in “Set-up” menu (page 27).
<p>Stereo broadcast sound switches on and off, or is distorted; the sound switches between stereo and monaural frequently</p>	<ul style="list-style-type: none"> • The antenna connection is loose or the antenna cable is damaged. Check the cable and connection on the TV, VCR, and on the wall (page 5). • Adjust the antenna direction for the minimum interference. Contact a Sony dealer for advice. • Signal transmission is low. Try using a booster. Otherwise, use the fine tuning (“AFT”) function (page 31).
General	
<p>The TV turns off automatically (the TV enters standby mode)</p>	<ul style="list-style-type: none"> • Check if the “Sleep Timer” is activated, or confirm the “Duration” setting of “On Timer” (page 28).
<p>The TV turns on automatically</p>	<ul style="list-style-type: none"> • Check if the “On Timer” is activated (page 28).
<p>Some input sources cannot be selected</p>	<ul style="list-style-type: none"> • Select “Video Labels” in the “AV Set-up” menu and cancel “Skip” of the input source (page 26).
<p>The remote does not function</p>	<ul style="list-style-type: none"> • Replace the batteries.
<p>The “Store Display Mode: On” message appears on the screen</p>	<ul style="list-style-type: none"> • Select “Factory Settings” in the “Set-up” menu (page 28).
<p>The wide screen mode changes spontaneously when “Auto Wide” is “On”</p>	<ul style="list-style-type: none"> • During a transition between two programmes, the TV detects the optimum wide screen mode. During this period, an irregular wide screen mode may appear. • The wide mode is switched automatically according to the revised signal with a Wide ID signal. • The “Auto Wide” feature stops working temporarily when you press  , and resumes after a while. To fix in the manually selected wide screen mode, set “Auto Wide” to “Off” in the “Screen” menu (page 25).

Problem	Cause/Remedy
Text display is incomplete or garbled	<ul style="list-style-type: none"> Your area may not be able to receive Text. Text is displayed only in the area that is covered by Text services. The antenna connection is loose or the antenna cable is damaged. Check the cable and connection on the TV, VCR, and on the wall (page 5). Adjust the antenna direction. Contact a Sony dealer for advice. Signal transmission is too low. Try using a booster. Using the fine tuning ("AFT") function may improve the picture (page 31).
Cannot play shooting games	<ul style="list-style-type: none"> Some shooting games which involve pointing a light beam at the TV screen with an electronic gun or rifle cannot be used with your TV. For details, see the instruction manual supplied with the video game software.
The TV cabinet creaks	<ul style="list-style-type: none"> Changes in room temperature sometimes make the TV cabinet expand or contract, causing a noise. This does not indicate a malfunction.
Static discharge is felt when touching the TV cabinet	<ul style="list-style-type: none"> This is the same static discharge that is felt when touching metal door handles or car doors especially when the air is dry, for example in winter. This does not indicate a malfunction.
Weak signal (signal level indicator displayed in red)	<ul style="list-style-type: none"> Check the antenna/cable connection. Set the "Signal Booster" to "Auto" (page 31) or try using an external booster.
Sound does not match pictures on the screen when audio is output directly from the amplifier system	<ul style="list-style-type: none"> Adjust the sound delay settings from the connected equipment to minimize the time gap between the audio and video output.



Customer support

<http://www.sony-asia.com/support>



Printed on 70% or more recycled paper using
VOC (Volatile Organic Compound)-free
vegetable oil based ink.



* 3 2 9 3 0 3 8 1 5 * (1)

<http://www.sony.net/>

Printed in Malaysia