

Dual Bias Resistor Transistor

LMBT3906DW1T1G

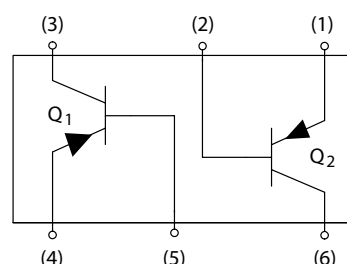
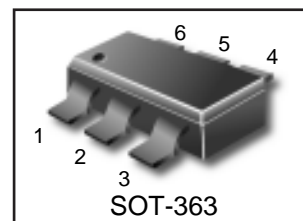

The LMBT3906DW1T1 device is a spin-off of our popular SOT-23/SOT-323 three-lead device. It is designed for general purpose amplifier applications and is housed in the SOT-363 six-lead surface mount package. By putting two discrete devices in one package, this device is ideal for low-power surface mount applications where board space is at a premium.

- h_{FE} , 100–300
- Low $V_{CE(sat)}$, ≤ 0.4 V
- Simplifies Circuit Design
- Reduces Board Space
- Reduces Component Count
- Available in 8 mm, 7-inch/3,000 Unit Tape and Reel
- Device Marking: LMBT3906DW1T1G = A2

Features

- We declare that the material of product complies with RoHS requirements.

MAXIMUM RATINGS

Rating	Symbol	Value	Unit
Collector–Emitter Voltage	V_{CEO}	–40	Vdc
Collector–Base Voltage	V_{CBO}	–40	Vdc
Emitter–Base Voltage	V_{EBO}	–5.0	Vdc
Collector Current – Continuous	I_C	–200	mAdc
Electrostatic Discharge	ESD	HBM>16000, MM>2000	V

THERMAL CHARACTERISTICS

Characteristic	Symbol	Max	Unit
Total Package Dissipation ⁽¹⁾ $T_A = 25^\circ\text{C}$	P_D	150	mW
Thermal Resistance Junction to Ambient	$R_{\theta JA}$	833	$^\circ\text{C/W}$
Junction and Storage Temperature Range	T_J, T_{stg}	–55 to +150	$^\circ\text{C}$

1. Device mounted on FR4 glass epoxy printed circuit board using the minimum recommended footprint.

ORDERING INFORMATION

Device	Marking	Shipping
LMBT3906DW1T1G	A2	3000 Units/Reel
LMBT3906DW1T1G	A2	10000 Units/Reel

LMBT3906DW1T1G
ELECTRICAL CHARACTERISTICS ($T_A = 25^\circ\text{C}$ unless otherwise noted)

Characteristic	Symbol	Min	Max	Unit
OFF CHARACTERISTICS				
Collector–Emitter Breakdown Voltage ⁽²⁾	$V_{(BR)CEO}$	-40	–	Vdc
Collector–Base Breakdown Voltage	$V_{(BR)CBO}$	-40	–	Vdc
Emitter–Base Breakdown Voltage	$V_{(BR)EBO}$	-5.0	–	Vdc
Base Cutoff Current	I_{BL}	–	-50	nAdc
Collector Cutoff Current	I_{CEX}	–	-50	nAdc

ON CHARACTERISTICS (2)

DC Current Gain ($I_C = -0.1$ mAdc, $V_{CE} = -1.0$ Vdc) ($I_C = -1.0$ mAdc, $V_{CE} = -1.0$ Vdc) ($I_C = -10$ mAdc, $V_{CE} = -1.0$ Vdc) ($I_C = -50$ mAdc, $V_{CE} = -1.0$ Vdc) ($I_C = -100$ mAdc, $V_{CE} = -1.0$ Vdc)	h_{FE}	60 80 100 60 30	– – 300 – –	–
Collector–Emitter Saturation Voltage ($I_C = -10$ mAdc, $I_B = -1.0$ mAdc) ($I_C = -50$ mAdc, $I_B = -5.0$ mAdc)	$V_{CE(sat)}$	– –	-0.25 -0.4	Vdc
Base–Emitter Saturation Voltage ($I_C = -10$ mAdc, $I_B = -1.0$ mAdc) ($I_C = -50$ mAdc, $I_B = -5.0$ mAdc)	$V_{BE(sat)}$	-0.65 –	-0.85 -0.95	Vdc

SMALL–SIGNAL CHARACTERISTICS

Current–Gain – Bandwidth Product	f_T	250	–	MHz
Output Capacitance	C_{obo}	–	4.5	pF
Input Capacitance	C_{ibo}	–	10.0	pF

 2. Pulse Test: Pulse Width ≤ 300 μs ; Duty Cycle $\leq 2.0\%$.

ELECTRICAL CHARACTERISTICS ($T_A = 25^\circ\text{C}$ unless otherwise noted) (Continued)

Characteristic	Symbol	Min	Max	Unit
Input Impedance ($V_{CE} = -10$ Vdc, $I_C = -1.0$ mAdc, $f = 1.0$ kHz)	h_{ie}	2.0	12	$k\ \Omega$
Voltage Feedback Ratio ($V_{CE} = -10$ Vdc, $I_C = -1.0$ mAdc, $f = 1.0$ kHz)	h_{re}	0.1	10	$\times 10^{-4}$
Small–Signal Current Gain ($V_{CE} = -10$ Vdc, $I_C = -1.0$ mAdc, $f = 1.0$ kHz)	h_{fe}	100	400	–
Output Admittance ($V_{CE} = -10$ Vdc, $I_C = -1.0$ mAdc, $f = 1.0$ kHz)	h_{oe}	3.0	60	μmhos
Noise Figure ($V_{CE} = -5.0$ Vdc, $I_C = -100$ μAdc , $R_S = 1.0$ $k\ \Omega$, $f = 1.0$ kHz)	NF	–	4.0	dB

SWITCHING CHARACTERISTICS

Delay Time	($V_{CC} = -3.0$ Vdc, $V_{BE} = 0.5$ Vdc)	t_d	–	35	ns
Rise Time	($I_C = -10$ mAdc, $I_{B1} = -1.0$ mAdc)	t_r	–	35	
Storage Time	($V_{CC} = -3.0$ Vdc, $I_C = -10$ mAdc)	t_s	–	225	ns
Fall Time	($I_{B1} = I_{B2} = -1.0$ mAdc)	t_f	–	75	

LMBT3906DW1T1G

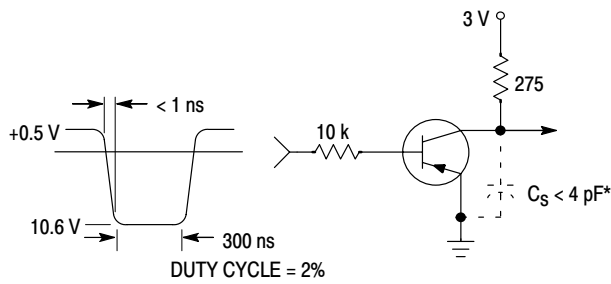

Figure 1. Delay and Rise Time Equivalent Test Circuit

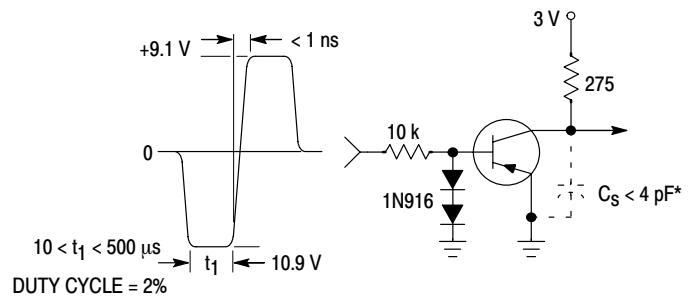

Figure 2. Storage and Fall Time Equivalent Test Circuit

* Total shunt capacitance of test jig and connectors

TYPICAL TRANSIENT CHARACTERISTICS

— $T_J = 25^\circ\text{C}$
 - - - $T_J = 125^\circ\text{C}$

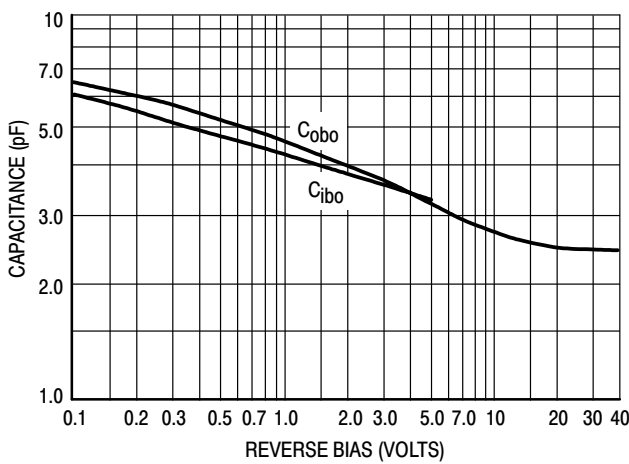

Figure 3. Capacitance

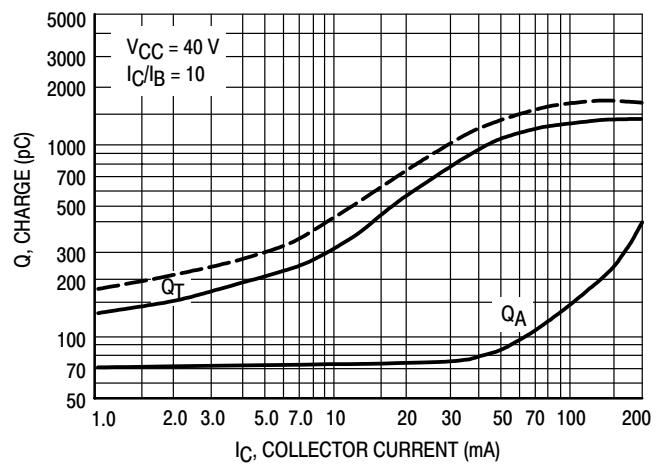

Figure 4. Charge Data

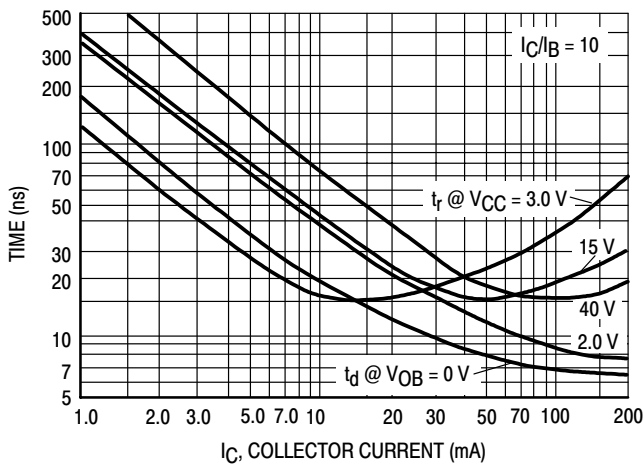

Figure 5. Turn-On Time

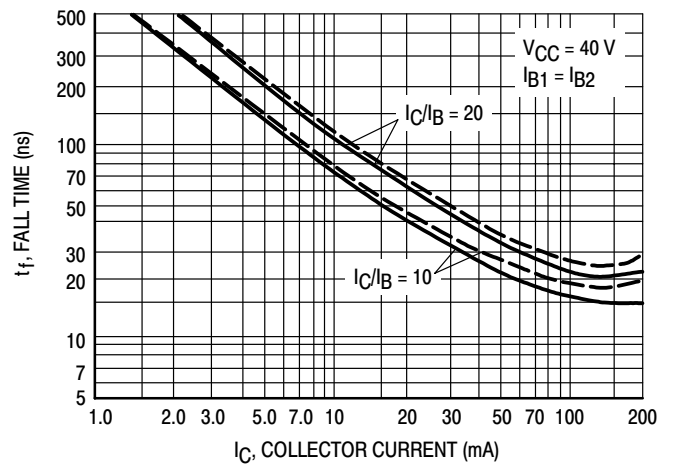

Figure 6. Fall Time

LMBT3906DW1T1G

**TYPICAL AUDIO SMALL-SIGNAL CHARACTERISTICS
NOISE FIGURE VARIATIONS**

($V_{CE} = -5.0$ Vdc, $T_A = 25^\circ\text{C}$, Bandwidth = 1.0 Hz)

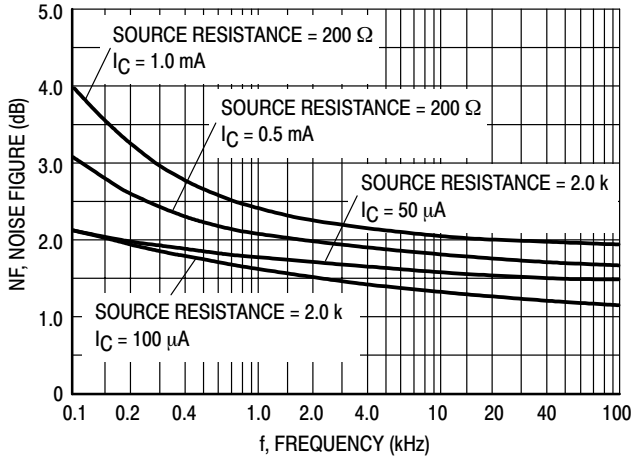

Figure 7.

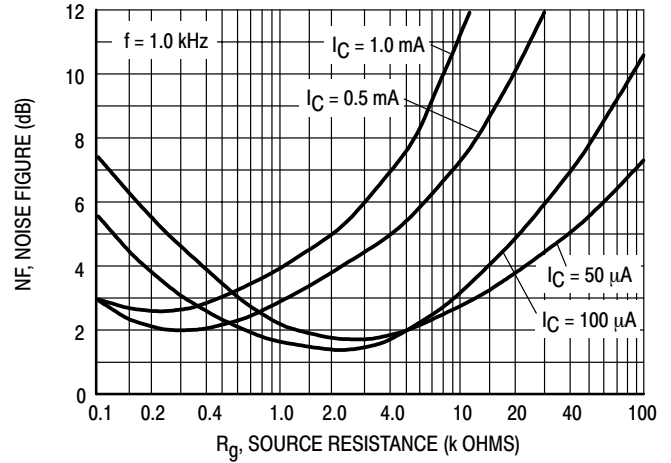

Figure 8.

h PARAMETERS

($V_{CE} = -10$ Vdc, $f = 1.0$ kHz, $T_A = 25^\circ\text{C}$)

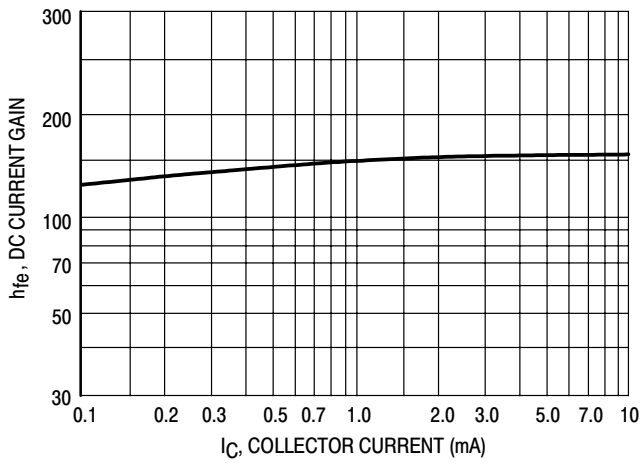

Figure 9. Current Gain

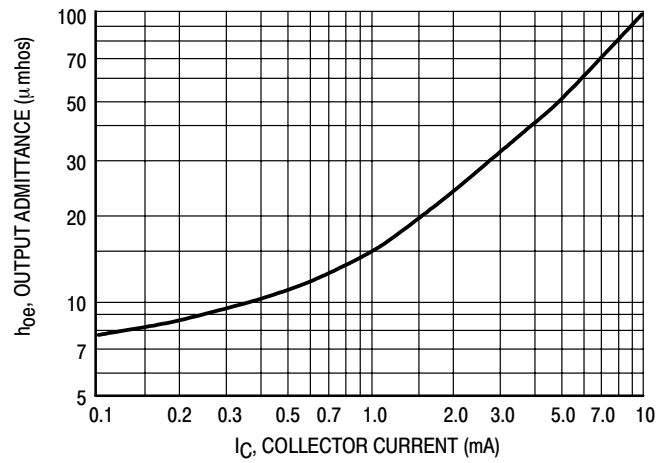

Figure 10. Output Admittance

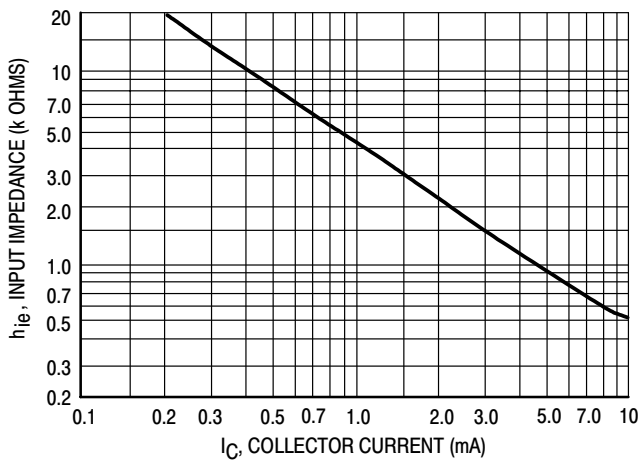

Figure 11. Input Impedance

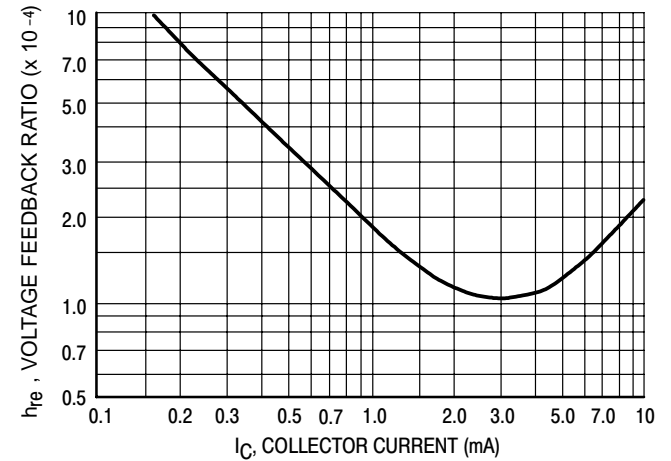

Figure 12. Voltage Feedback Ratio

TYPICAL STATIC CHARACTERISTICS

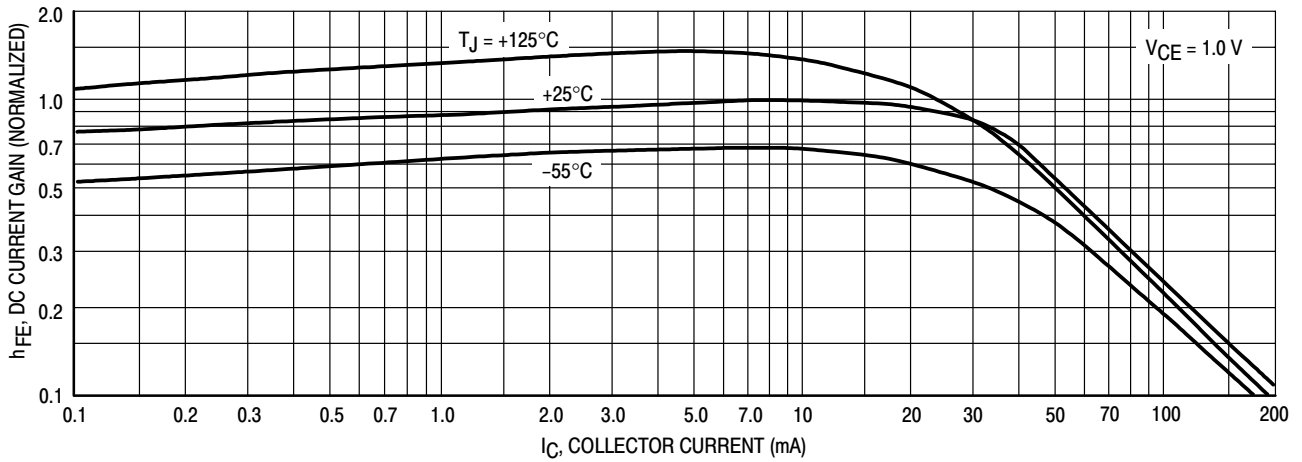

Figure 13. DC Current Gain

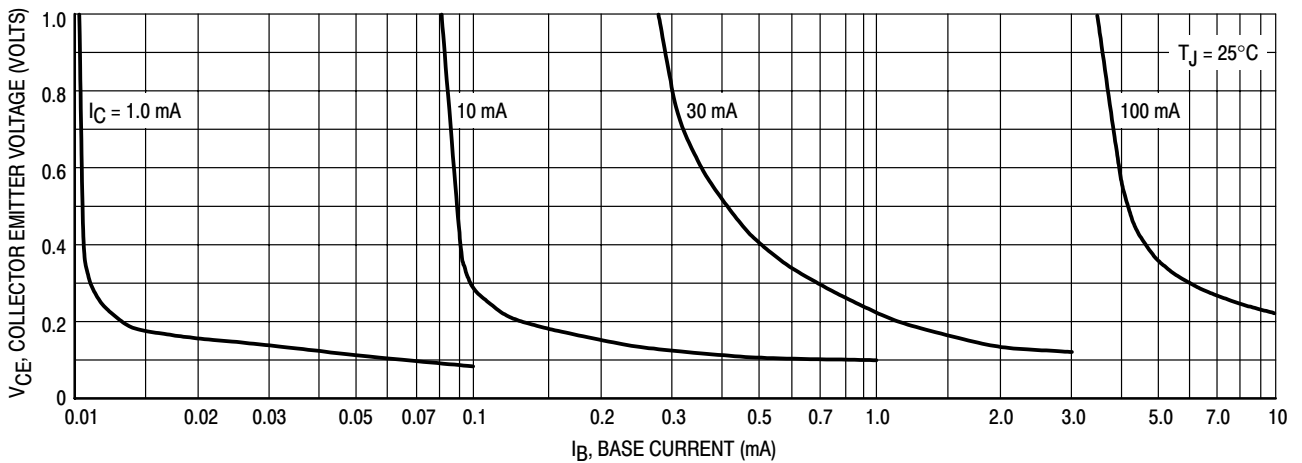

Figure 14. Collector Saturation Region

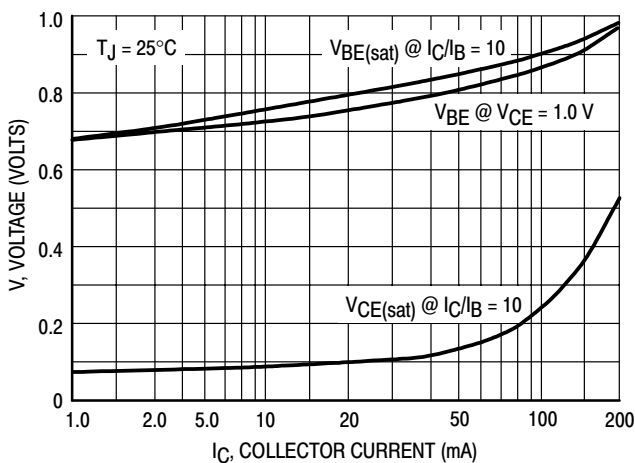

Figure 15. "ON" Voltages

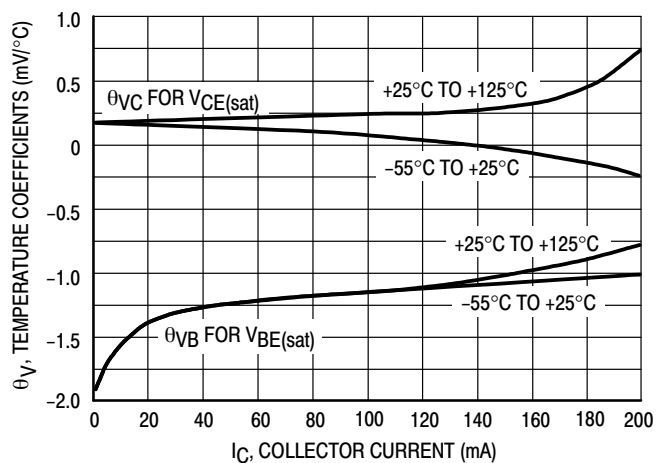
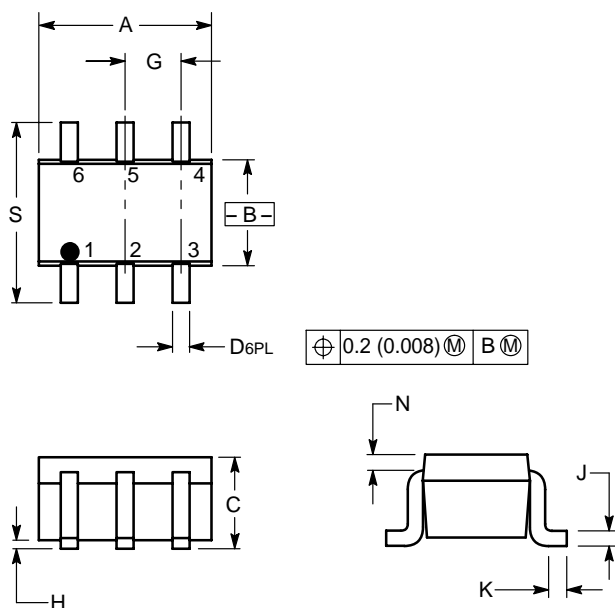

Figure 16. Temperature Coefficients

LMBT3906DW1T1G

SC-88/SOT-363



NOTES:

1. DIMENSIONING AND TOLERANCING PER ANSI Y14.5M, 1982.
2. CONTROLLING DIMENSION: INCH.

DIM	INCHES		MILLIMETERS	
	MIN	MAX	MIN	MAX
A	0.071	0.087	1.80	2.20
B	0.045	0.053	1.15	1.35
C	0.031	0.043	0.80	1.10
D	0.004	0.012	0.10	0.30
G	0.026 BSC		0.65 BSC	
H	---	0.004	---	0.10
J	0.004	0.010	0.10	0.25
K	0.004	0.012	0.10	0.30
N	0.008 REF		0.20 REF	
S	0.079	0.087	2.00	2.20

- PIN 1. EMITTER 2
- 2. BASE 2
- 3. COLLECTOR 1
- 4. EMITTER 1
- 5. BASE 1
- 6. COLLECTOR 2

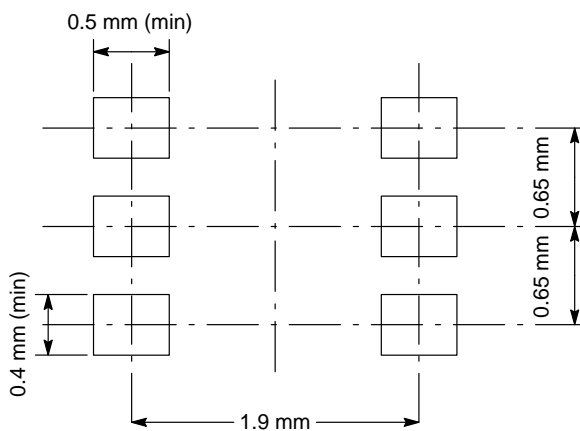

EMBOSSED TAPE AND REEL DATA FOR DISCRETES

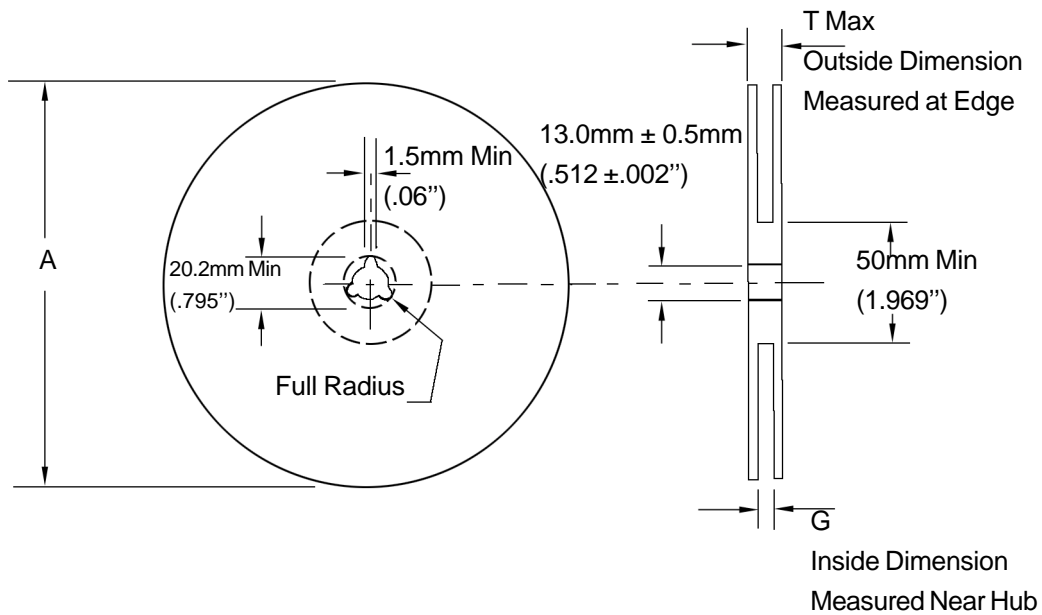

Size	A Max	G	T Max
8 mm	330mm (12.992")	8.4mm+1.5mm, -0.0 (.33"+.059", -0.00)	14.4mm (.56")

Reel Dimensions

Metric Dimensions Govern — English are in parentheses for reference only

Storage Conditions

Temperature: 5 to 40 Deg.C (20 to 30 Deg. C is preferred)

Humidity: 30 to 80 RH (40 to 60 is preferred)

Recommended Period: One year after manufacturing

(This recommended period is for the soldering condition only. The characteristics and reliabilities of the products are not restricted to this limitation)

Shipment Specification

