

RoHS **Pb** **GREEN** **SP03-6 (SO-8) Series**

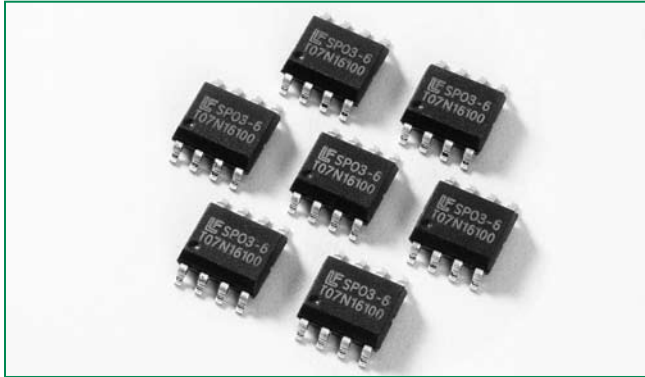

Description

This new broadband protection device from Littelfuse provides overvoltage protection for applications such as 10/100/1000 BaseT Ethernet, T3/E3 DS3 interfaces, ADSL2+, and VDSL2+. This new protector combines the TVS diode element with a diode rectifier bridge to provide both longitudinal and differential protection in one package. This design innovation results in a capacitive loading characteristic that is log-linear with respect to the signal voltage across the device. This reduces intermodulation (IM) distortion caused by a typical solid-state protection solution. The application schematic provides the connection information.

Agency Approvals - Pending

Agency	Agency File Number
	E128662

Pinout

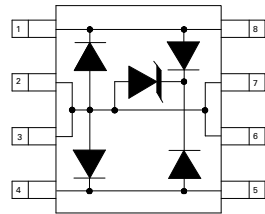

SO-8 (Top View)

Features

- RoHS compliant
- MS-012 surface mount package (JEDEC SO-8)
- Low insertion loss, log-linear capacitance
- Combined longitudinal and metallic protection
- Clamping speed of nanoseconds
- UL 94V-0 epoxy molding
- Pending UL recognized component
- Low clamping voltage

Applications

- T1/E1 Line cards
- T3/E3 and DS3 Interfaces
- STS-1 Interfaces
- 10/100/1000 BaseT Ethernet

Functional Block Diagram

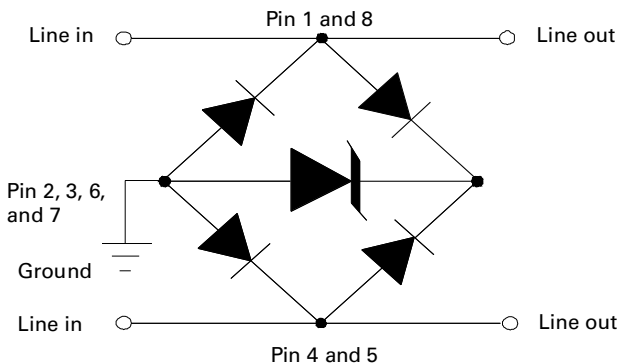

SP03-6 (SO-8)

Absolute Maximum Ratings

Parameter	Rating	Units
Peak Pulse Current (8/20μs)	150	A
Peak Pulse Power (8/20μs)	2800	W
IEC 61000-4-2, Direct Discharge, (Level 4)	30	kV
IEC 61000-4-2, Air Discharge, (Level 4)	30	kV
IEC 61000-4-5 (8/20μs)	100	A
Telcordia GR 1089 (Intra-Building) (2/10μs)	100	A
ITU K.20 (5/310μs)	40	A

CAUTION: Stresses above those listed in "Absolute Maximum Ratings" may cause permanent damage to the device. This is a stress only rating and operation of the device at these or any other conditions above those indicated in the operational sections of this specification is not implied.

Thermal Information

Parameter	Rating	Units
SOIC Package	170	°C/W
Operating Temperature Range	-55 to 125	°C
Storage Temperature Range	-65 to 150	°C
Maximum Junction Temperature	150	°C
Maximum Lead Temperature (Soldering 10s) (SOIC - Lead Tips Only)	300	°C

Electrical Characteristics (T_{OP} = 25°C)

Parameter	Symbol	Test Conditions	Min	Typ	Max	Units
Reverse Stand-Off Voltage	V _{RWM}	-	-	-	6	V
Reverse Breakdown Voltage	V _{BR}	I _T = 1mA	6.8	-	-	V
Reverse Leakage Current	I _R	V _{RWM} = 6V, T = 25°C	-	-	25	μA
Clamping Voltage, Line-Ground	V _C	I _{PP} = 50A, t _p = 8/20 μs	-	-	15	V
Clamping Voltage, Line-Ground	V _C	I _{PP} = 100A, t _p = 8/20 μs	-	-	20	V
Junction Capacitance	C _j	Between I/O Pins and Ground V _R = 0V, f = 1MHz	-	16	25	pF
		Between I/O Pins V _R = 0V, f = 1MHz	-	8	12	pF

Figure 1: Non-repetitive Peak Pulse Current vs. Pulse Time



Figure 2: Current Derating Curve

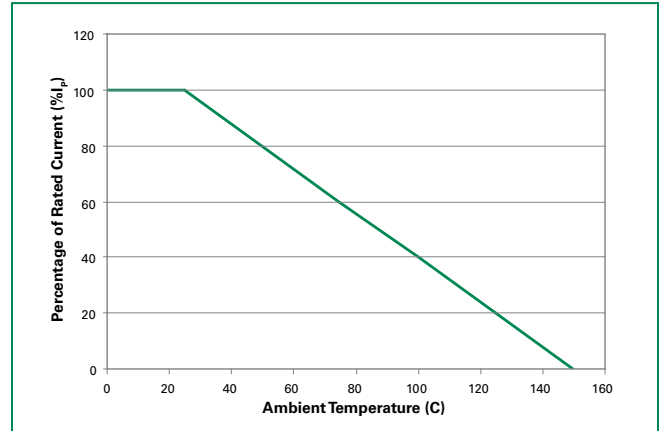

Figure 3: Pulse Waveform

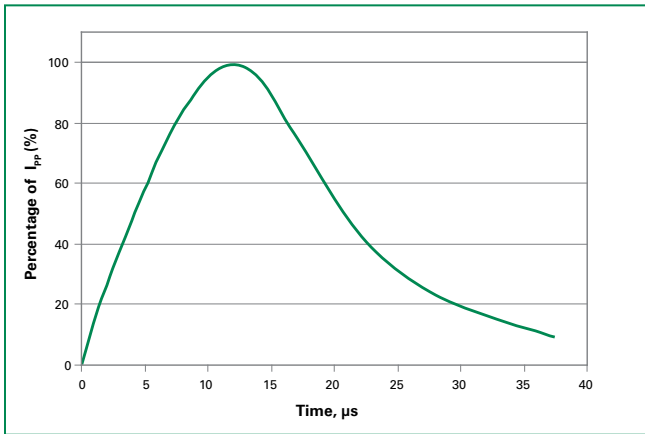

Figure 4: Clamping Voltage vs. Peak Pulse Current

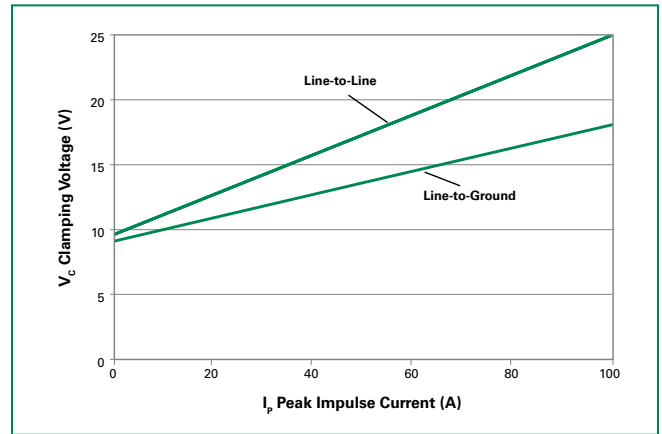

Figure 5: Capacitance vs. Reverse Voltage

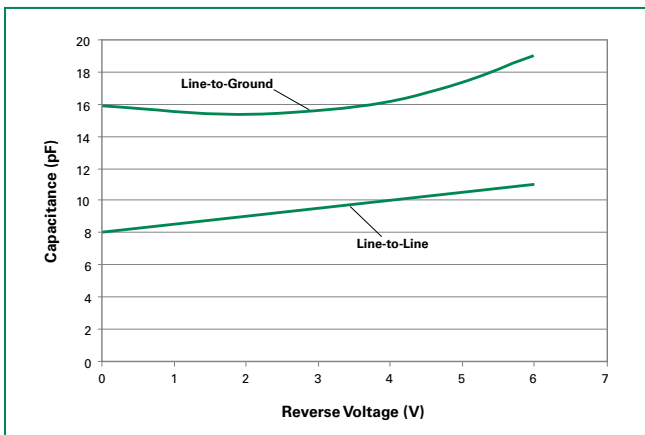
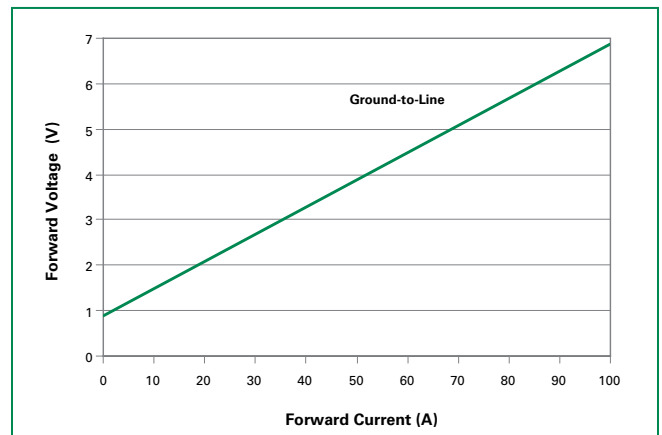

Figure 6: Forward Voltage vs. Forward Current



SP03-6 (SO-8)

Application Example

The following schematic shows a high-speed data interface protection solution. The SP03-6 provides both metallic (differential) and longitudinal (common mode) protection from lightning induced surge events. Its surge rating is compatible with the intra-building surge requirements of Telcordia's GR-1089-CORE, and the Basic Level

Recommendations of ITU K.20 and .21. This device protects against both positive and negative induced surge events. The TeleLink fuse provides overcurrent protection for the long term 50/60 Hz power fault events.

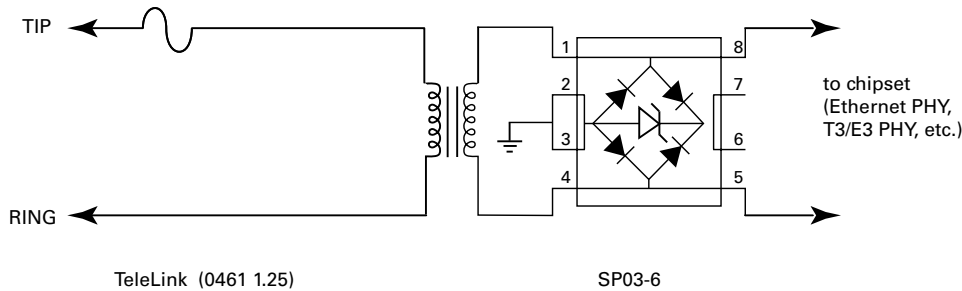

Soldering Parameters

Reflow Condition		Pb – Free assembly
Pre Heat	- Temperature Min ($T_{s(min)}$)	150°C
	- Temperature Max ($T_{s(max)}$)	200°C
	- Time (min to max) (t_s)	60 – 180 secs
Average ramp up rate (Liquidus) Temp (T_L) to peak		3°C/second max
$T_{s(max)}$ to T_L - Ramp-up Rate		3°C/second max
Reflow	- Temperature (T_L) (Liquidus)	217°C
	- Temperature (t_L)	60 – 150 seconds
Peak Temperature (T_p)		250 ^{+0/-5} °C
Time within 5°C of actual peak Temperature (t_p)		20 – 40 seconds
Ramp-down Rate		6°C/second max
Time 25°C to peak Temperature (T_p)		8 minutes Max.
Do not exceed		260°C

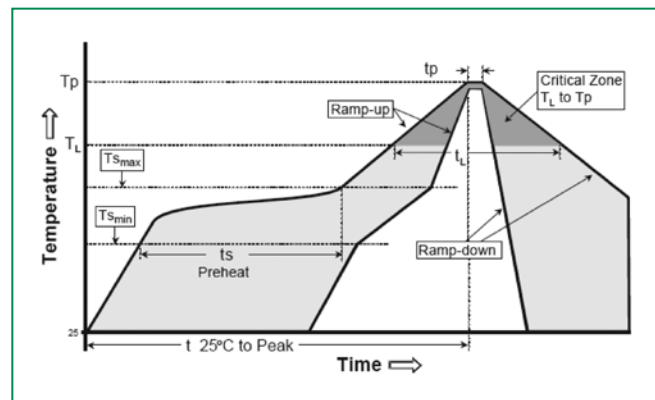

Package Dimensions - Mechanical Drawings and Recommended Solder Pad Outline

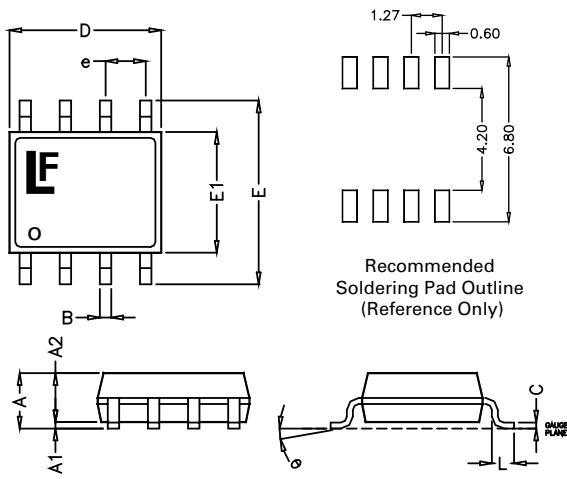

Package	MS-012 (SO-8)			
Pins	8			
JEDEC	MO-223 Issue A			
	Millimetres		Inches	
	Min	Max	Min	Max
A	1.35	1.75	0.053	0.069
A1	0.10	0.25	0.004	0.010
A2	1.25	1.65	0.043	0.065
B	0.31	0.51	0.012	0.020
c	0.017	0.25	0.007	0.010
D	4.80	5.00	0.189	0.197
E	5.80	6.20	0.228	0.244
E1	3.80	4.00	0.150	0.157
e	1.27 BSC		0.050 BSC	
L	0.40	1.27	0.016	0.050

Part Numbering System

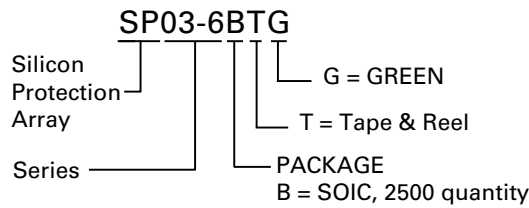

Product Characteristics

Lead Plating	Matte Tin
Lead Material	Copper Alloy
Lead Coplanarity	0.004 inches (0.102mm)
Substitute Material	Silicon
Body Material	Molded Epoxy
Flammability	UL94-V-0

Notes :

1. All dimensions are in millimeters
2. Dimensions include solder plating.
3. Dimensions are exclusive of mold flash & metal burr.
4. All specifications comply to JEDEC SPEC MO-223 Issue A
5. Blo is facing up for mold and facing down for trim/form, i.e. reverse trim/form.
6. Package surface matte finish VDI 11-13.

Part Marking System

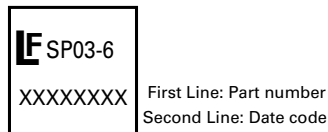

Ordering Information

Part Number	Package	Marking	Min. Order Qty.
SP03-6BTG	SOIC Tape & Reel	SP03-6	2500

SP03-6 (SO-8)

Embossed Carrier Tape & Reel Specification - SOIC Package

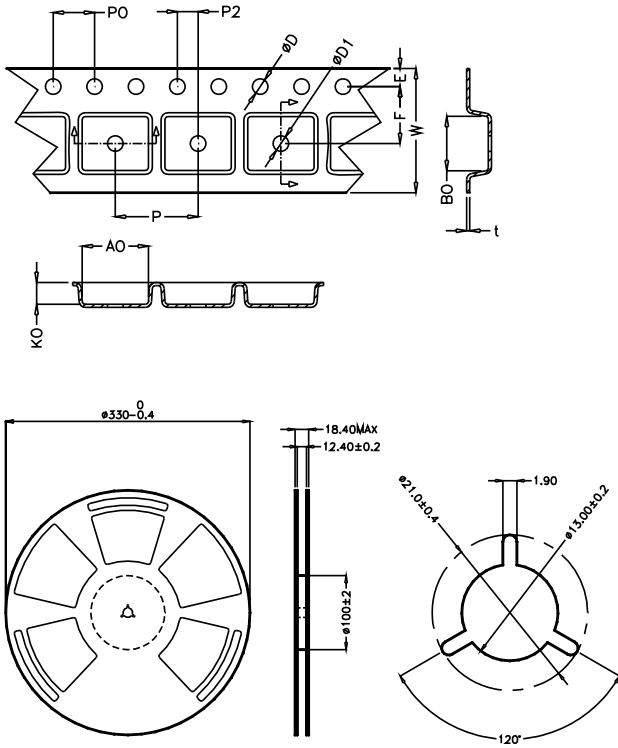

Dimensions

	Millimetres		Inches	
	Min	Max	Min	Max
E	1.65	1.85	0.065	0.073
F	5.4	5.6	0.213	0.22
P2	1.95	2.05	0.077	0.081
D	1.5	1.6	0.059	0.063
D1	1.50 Min		0.059 Min	
P0	3.9	4.1	0.154	0.161
10P0	40.0 +/- 0.20		1.574 +/- 0.008	
W	11.9	12.1	0.468	0.476
P	7.9	8.1	0.311	0.319
A0	6.3	6.5	0.248	0.256
B0	5.1	5.3	0.2	0.209
K0	2	2.2	0.079	0.087
t	0.30 +/- 0.05		0.012 +/- 0.002	