









Automotive

Innovative package options

Suffix	BQ	PW	D	PW	BQ	PW	GW	GM
								
	SOT763-1	SOT403-1	SOT108-1	SOT402-1	SOT764-1	SOT360-1	SOT363	SOT886
	16-pin	16-pin	14-pin	14-pin	20-pin	20-pin	6-pin	6-pin
Width (mm)	2.50	6.40	6.00	6.40	2.50	6.40	2.10	1.00
Length (mm)	3.50	5.00	8.65	5.00	4.50	6.50	2.00	1.45
Pitch (mm)	0.50	0.65	1.27	0.65	0.50	0.65	0.65	0.50

Q100 Logic samples available in e-sample store. Order them today!
Haven't found your function? Please contact your local NXP representative.



NXP Logic – Q100 logic portfolio

Continuing to lead the way in automotive logic

www.nxp.com

© 2012 NXP Semiconductors N.V.
All rights reserved. Reproduction in whole or in part is prohibited without the prior written consent of the copyright owner. The information presented in this document does not form part of any quotation or contract, is believed to be accurate and reliable and may be changed without notice. No liability will be accepted by the publisher for any consequence of its use. Publication thereof does not convey nor imply any license under patent- or other industrial or intellectual property rights.

Date of release: November 2012
Document order number: 9397 750 17356
Printed in the Netherlands



Introduction

The operating environment of automobile semiconductor components is much more hostile than that of semiconductors used in home or portable applications. A television set will generally spend its operating lifetime within an ambient temperature range of 0 °C to 40 °C. Due to internal heating, its semiconductor devices can be expected to operate between 20 °C and 60 °C. By comparison, an automobile is expected to start at temperatures lower than -20 °C and, in some cases, operate within the engine compartment at temperatures approaching 125 °C.

To ensure the reliability of automotive electronics, the Automotive Electronics Council introduced its AEC-Q100 standard which outlines procedures to be followed to ensure integrated circuits meet the quality and reliability levels required by automotive applications. As the global number one supplier, the introduction of its Q100 logic portfolio shows NXP continuing to lead the way in automotive logic.

Key benefits of the Q100 logic portfolio AEC-Q100 product qualification and reliability monitoring

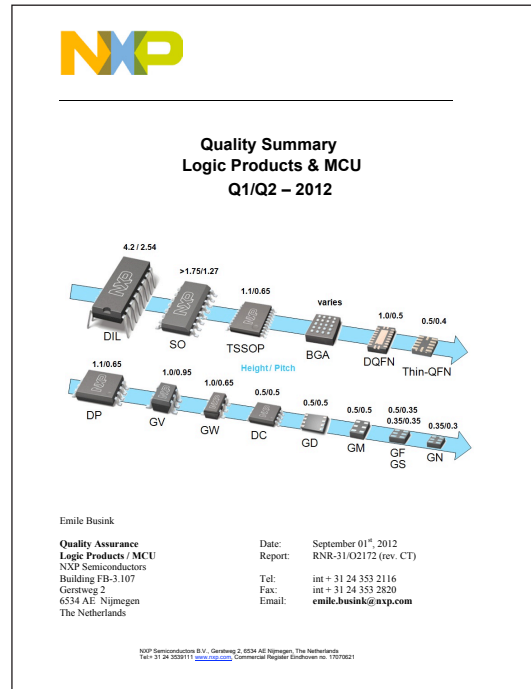

Operating at elevated temperatures reduces the lifetime of a semiconductor and temperature cycling has a negative impact on the stability of a package. In cases where there is no history of a product's reliability within automotive applications, a series of stresses to simulate the life cycle within an automotive environment must be applied to guarantee conformance to the AEC-Q100 standard.

To ensure continued reliability, NXP logic maintains an extensive reliability monitoring program; the results of which are published half yearly. These QSUM reports are available upon request via your NXP sales representative.

Tightened manufacturing process controls

Q100 devices are

- ▶ manufactured in TS16949 certified and VDA approved production facilities
- ▶ flagged as automotive lots
- ▶ subjected to additional process flow quality gates and stricter rules for lot dis-positioning and maverick lot handling

This ensures that automotive products

- ▶ receive highest priority
- ▶ have greater traceability for improved quality analysis
- ▶ that become outlier lots, passing a quality gate but outside of the acceptable distribution, are assigned to standard, non-Q100, types.

Six sigma design, zero defect test and inspection methodology

Six sigma design philosophy is applied to all Q100 devices. This ensures that an end user application designed to the datasheet limits can tolerate a shift as high as one and a half sigma in NXP's manufacturing processes. As the process control limits are much tighter than one and a half sigma, this virtually guarantees trouble free end user applications. During electrical test process, average test limits or statistical test limits are applied to screen outliers within automotive lots. Figure 1 shows the distribution of devices passing a test and the calculated statistical test limits in red. Although the outliers are within the upper and lower specification limits they are not delivered as Q100 products.

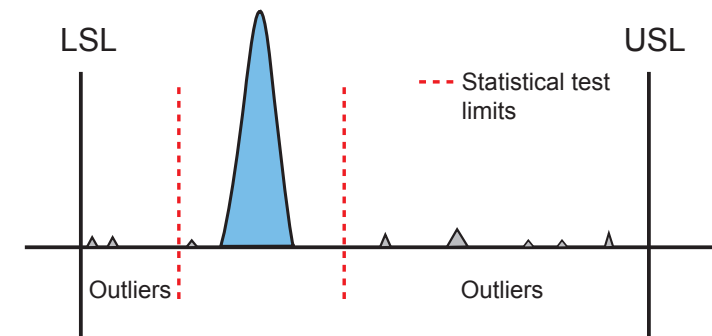

Fig. 1 Application of statistical test limits

Dedicated website and datasheets

A summary of NXP logic's Q100 portfolio including a search by function and a parametric search within each function can be found at www.nxp.com/products/automotive/logic, and unlike the standard types, each Q100 device has a dedicated datasheet confirming that it has been qualified in accordance with AEC-Q100 and is suitable for automotive applications.

Priority technical support

NXP's first and second tier technical support teams give Q100 product design-in assistance their highest priority and upon request AEC-Q100 production part approval process (PPAP) qualification data will be made available. Due to the stricter qualification requirements of automotive end user applications, a 180 day process change notification (PCN) approval cycle is applied for Q100 products instead of the 90 day PCN approval cycle for standard types. In the unlikely event of a quality issue, NXP logic guarantees a 10 day through put time with initial verification within 24 hours for its Q100 portfolio.

Examples of NXP Q100 logic automotive application areas

i/o expansion

Large pin count controllers are expensive, so when possible to reduce the complexity and pin-count of control solutions, input/output expansion devices such as multiplexer/de-multiplexer devices are used. Figure 2 shows an example of an 8:1 multiplexer used to sequentially switch analog sensor signals to a single analog to digital pin of a micro-controller.

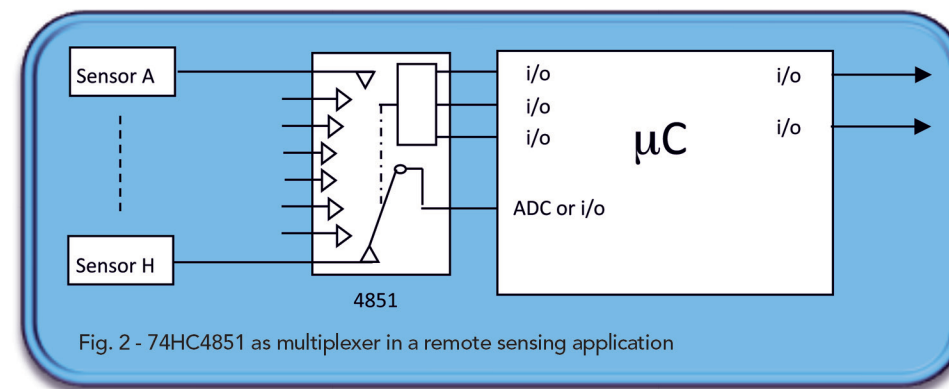

Fig. 2 - 74HC4851 as multiplexer in a remote sensing application

Interface logic

With high impedance inputs and low impedance outputs, interface logic such as registered or unregistered buffers and line drivers are used to interface between low drive outputs of a controller and higher loads of, for example, water pumps and window motors.

Display drivers

Display drivers integrate serial-in, parallel-out shift registers, which are common I/O expansion devices, with a number of MOSFET LED drivers. With 8-bit and 12-bit solutions, shift register based display drivers enable a controller to drive 8 or 12 LED's using 3 output lines. Cascading devices as shown in figure 3 increases the number of LED's controlled by the same 3 output lines. Display drivers reduce the size, complexity, pin count and ultimately cost of any micro-controller based solution.

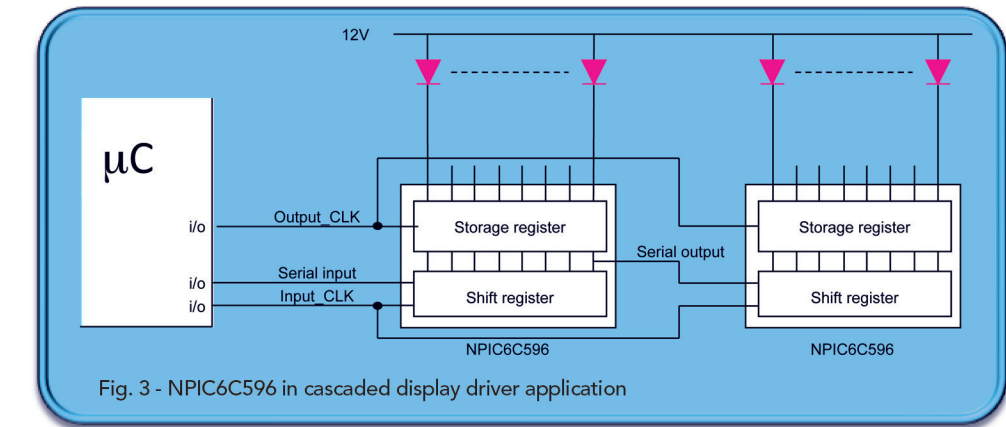

Fig. 3 - NPIC6C596 in cascaded display driver application

Control logic

Control applications such as engine control units and body control modules change settings based upon a combination of input signals. Control logic consists of simple Boolean functions, such as AND or NAND, to facilitate changing settings in simple sub-systems that don't require a micro-controller.

Display Logic	Function	Control Logic	Function
HEF4894B-Q100	12-stage shift-and-store register LED driver	74LVC1G125-Q100	bus buffer/line driver; 3-state
NPIC6C595-Q100	power logic 8-bit shift register; open-drain	74LVC1G14-Q100	single Schmitt trigger inverter
NPIC6C596-Q100	power logic 8-bit shift register; open-drain	74LVC1G17-Q100	single Schmitt trigger buffer
Interface logic	Function	74LVC1G32-Q100	single 2-input OR gate
HEF4093BT-Q100	quad 2-input NAND Schmitt trigger	74LVC244A-Q100	octal buffer/line driver; 3-state
HEF4094BT-Q100	8-stage shift-and-store register	74LVC245A-Q100	octal bus transceiver; 3-state
74HC(T)114-Q100	hex inverting Schmitt trigger	I/O expansion	Function
74HC(T)151-Q100	quad 2-input multiplexer	NX3L4051-Q100	low-ohmic single-pole octal-throw analog switch
74HC(T)244-Q100	octal buffer/line driver; 3-state	HEF4051B-Q100	8-channel analog multiplexer/demultiplexer
74AHC(T)14-Q100	hex inverting Schmitt trigger	HEF4052B-Q100	dual 4-channel analog multiplexer/demultiplexer
74AHC(T)1G08-Q100	2-input AND gate	HEF4066BT-Q100	quad single-pole single-throw analog switch
74AHC1G09-Q100	2-input AND gate with open-drain	74HC(T)138-Q100	3-to-8 line decoder/demultiplexer; inverting
74AHC(T)1G125-Q100	bus buffer/line driver; 3-state	74HC(T)165-Q100	8-bit parallel-in/serial out shift register
74AHC(T)244-Q100	bus buffer/line driver; 3-state	74HC(T)4051-Q100	8-channel analog multiplexer/demultiplexer
74AHC(T)125-Q100	quad buffer/line driver; 3-state	74HC(T)4052-Q100	dual 4-channel analog multiplexer/demultiplexer
Control Logic	Function	74HC(T)4053-Q100	triple 2-channel analog multiplexer/demultiplexer
HEF40106B-Q100	hex inverting Schmitt trigger	74HC(T)4066-Q100	16-channel analog multiplexer/demultiplexer
74HC(T)00-Q100	quad 2-input NAND gate	74HC(T)4851-Q100	8-channel analog mux/demux; injection-current control
74HC(T)04-Q100	hex inverter	74HC(T)4852-Q100	dual 4-channel analog mux/demux; injection-current control
74HC(T)08-Q100	quad 2-input AND gate	74HC(T)595-Q100	8-bit serial-in, serial or parallel-out shift register; 3-state
74HC(T)132-Q100	quad 2-input NAND Schmitt trigger	74LVC08-Q100	quad 2-input AND gate
74HC(T)1G08-Q100	2-input AND gate	74LVC14-Q100	hex inverting Schmitt trigger with 5 V tolerant input
74LVC1G08-Q100	single 2-input AND gate		