

VHF/UHF Transistors

- We declare that the material of product compliance with RoHS requirements.

Ordering Information

Device	Marking	Shipping
LMBTH10LT1G	3EM	3000/Tape&Reel
LMBTH10LT3G	3EM	10000/Tape&Reel

MAXIMUM RATINGS

Rating	Symbol	Value	Unit
Collector–Emitter Voltage	V_{CEO}	25	Vdc
Collector–Base Voltage	V_{CBO}	30	Vdc
Emitter–Base Voltage	V_{EBO}	3.0	Vdc

THERMAL CHARACTERISTICS

Characteristic	Symbol	Max	Unit
Total Device Dissipation FR–5 Board, (1) $T_A = 25^\circ\text{C}$	P_D	225	mW
Derate above 25°C		1.8	mW/ $^\circ\text{C}$
Thermal Resistance, Junction to Ambient	$R_{\theta JA}$	556	$^\circ\text{C}/\text{W}$
Total Device Dissipation Alumina Substrate, (2) $T_A = 25^\circ\text{C}$	P_D	300	mW
Derate above 25°C		2.4	mW/ $^\circ\text{C}$
Thermal Resistance, Junction to Ambient	$R_{\theta JA}$	417	$^\circ\text{C}/\text{W}$
Junction and Storage Temperature	T_J, T_{stg}	-55 to +150	$^\circ\text{C}$

DEVICE MARKING

LMBTH10LT1G = 3EM

ELECTRICAL CHARACTERISTICS ($T_A = 25^\circ\text{C}$ unless otherwise noted.)

Characteristic	Symbol	Min	Typ	Max	Unit
----------------	--------	-----	-----	-----	------

OFF CHARACTERISTICS

Collector–Emitter Breakdown Voltage ($I_C = 1.0 \text{ mAdc}, I_E = 0$)	$V_{(BR)CEO}$	25	—	—	Vdc
Collector–Base Breakdown Voltage ($I_C = 100 \mu\text{Adc}, I_E = 0$)	$V_{(BR)CBO}$	30	—	—	Vdc
Emitter–Base Breakdown Voltage ($I_E = 10 \mu\text{Adc}, I_C = 0$)	$V_{(BR)EBO}$	3.0	—	—	Vdc
Collector Cutoff Current ($V_{CB} = 25\text{Vdc}, I_E = 0$)	I_{CBO}	—	—	100	nAdc
Collector Cutoff Current ($V_{CB} = 30\text{Vdc}, I_E = 0$)	I_{CBO}	—	—	100	uAdc
Emitter Cutoff Current ($V_{EB} = 2.0\text{Vdc}, I_C = 0$)	I_{EBO}	—	—	100	nAdc
Emitter Cutoff Current ($V_{EB} = 3.0\text{Vdc}, I_C = 0$)	I_{EBO}	—	—	10	uAdc

1. FR–5 = 1.0 x 0.75 x 0.062 in.

2. Alumina = 0.4 x 0.3 x 0.024 in. 99.5% alumina.

LMBTH10LT1G

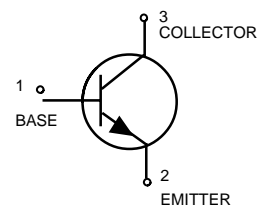
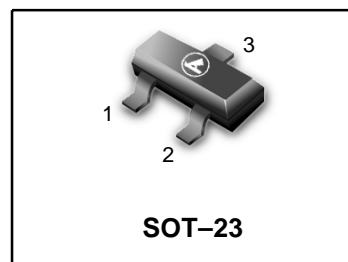

LMBTH10LT1G

ELECTRICAL CHARACTERISTICS ($T_A = 25^\circ\text{C}$ unless otherwise noted) (Continued)

Characteristic	Symbol	Min	Typ	Max	Unit
----------------	--------	-----	-----	-----	------

ON CHARACTERISTICS

DC Current Gain ($I_C = 4.0 \text{ mA}$, $V_{CE} = 10 \text{ Vdc}$)	h_{FE}	60	—	—	—
Collector–Emitter Saturation Voltage ($I_C = 4.0 \text{ mA}$, $I_B = 0.4 \text{ mA}$)	$V_{CE(sat)}$	—	—	0.5	Vdc
Base–Emitter On Voltage ($I_C = 4.0 \text{ mA}$, $V_{CE} = 10 \text{ Vdc}$)	V_{BE}	—	—	0.95	Vdc

SMALL–SIGNAL CHARACTERISTICS

Current Gain–Bandwidth Product ($V_{CE} = 10 \text{ Vdc}$, $I_C = 4.0 \text{ mA}$, $f = 100 \text{ MHz}$)	f_T	650	—	—	MHz
Collector –Base Capacitance ($V_{CB} = 10 \text{ Vdc}$, $I_E = 0$, $f = 1.0 \text{ MHz}$)	C_{cb}	—	—	0.7	pF
Collector –Base Feedback Capacitance ($V_{CB} = 10 \text{ Vdc}$, $I_E = 0$, $f = 1.0 \text{ MHz}$)	C_{fb}	—	—	0.65	pF
Collector Base Time Constant ($I_C = 4.0 \text{ mA}$, $V_{CB} = 10 \text{ Vdc}$, $f = 31.8 \text{ MHz}$)	$r_b' C_C$	—	—	9.0	ps

LMBTH10LT1G

TYPICAL CHARACTERISTICS

COMMON-BASE y PARAMETERS versus FREQUENCY

($V_{CB} = 10 \text{ Vdc}$, $I_C = 4.0 \text{ mAdc}$, $T_A = 25^\circ\text{C}$)

y_{ib} , INPUT ADMITTANCE

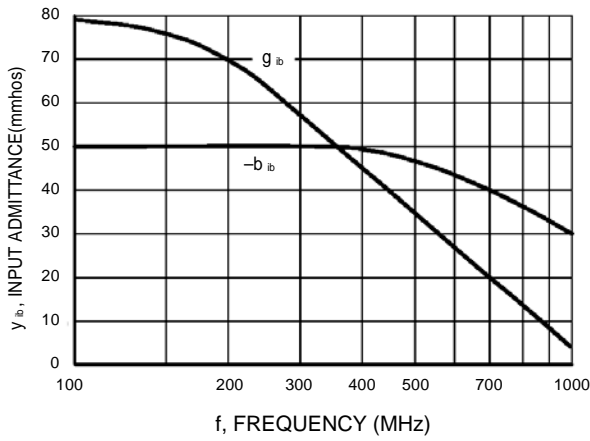

Figure 1. Rectangular Form

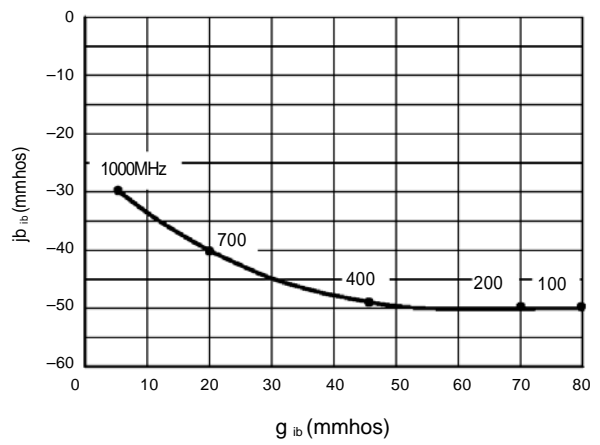

Figure 2. Polar Form

y_{fb} , FORWARD TRANSFER ADMITTANCE

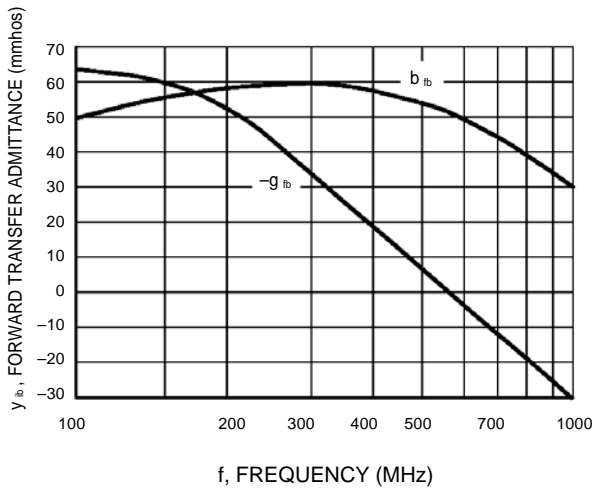

Figure 3. Rectangular Form

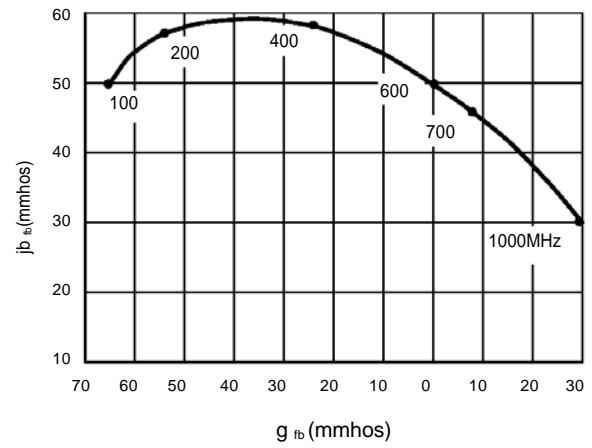

Figure 4. Polar Form

LMBTH10LT1G

TYPICAL CHARACTERISTICS

COMMON-BASE y PARAMETERS versus FREQUENCY

($V_{CB} = 10$ Vdc, $I_C = 4.0$ mA dc, $T_A = 25^\circ\text{C}$)

y_{rb} , REVERSE TRANSFER ADMITTANCE

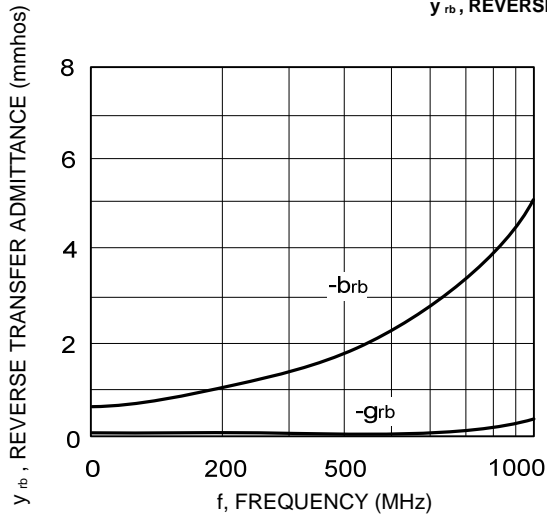

Figure 5. Rectangular Form

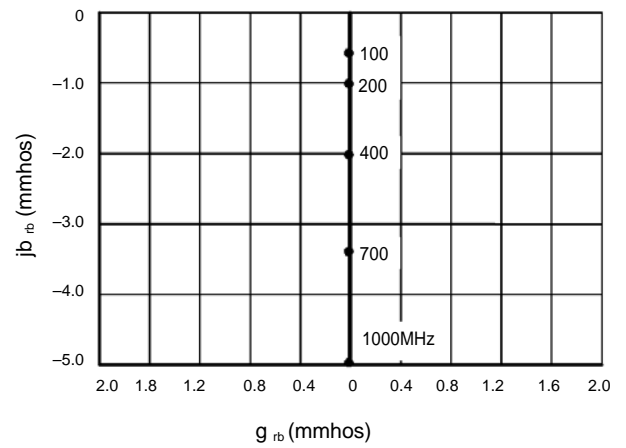

Figure 6. Polar Form

y_{ob} , OUTPUT ADMITTANCE

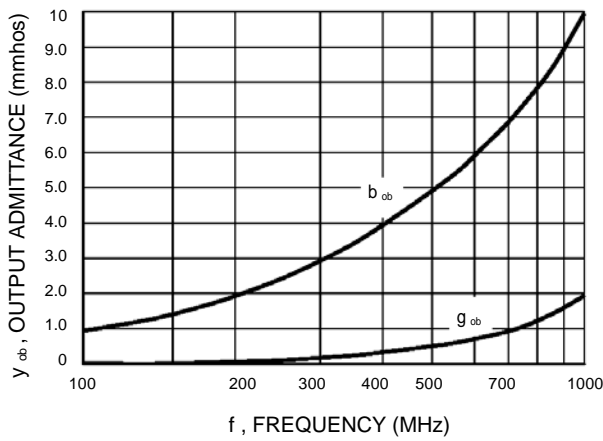

Figure 7. Rectangular Form

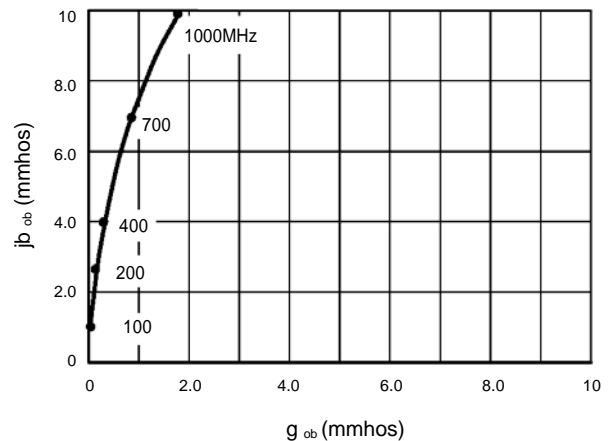
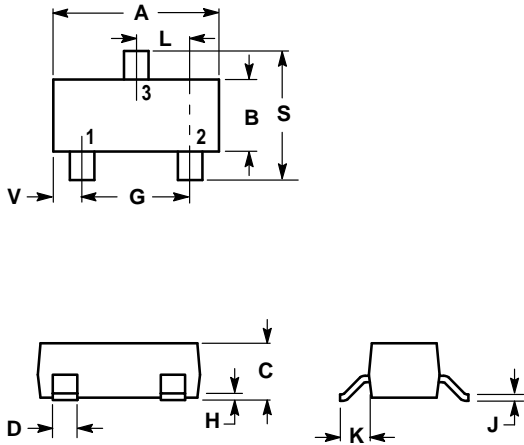

Figure 8. Polar Form

LMBTH10LT1G

SOT-23



NOTES:

1. DIMENSIONING AND TOLERANCING PER ANSI Y14.5M, 1982.
2. CONTROLLING DIMENSION: INCH.

DIM	INCHES		MILLIMETERS	
	MIN	MAX	MIN	MAX
A	0.1102	0.1197	2.80	3.04
B	0.0472	0.0551	1.20	1.40
C	0.0350	0.0440	0.89	1.11
D	0.0150	0.0200	0.37	0.50
G	0.0701	0.0807	1.78	2.04
H	0.0005	0.0040	0.013	0.100
J	0.0034	0.0070	0.085	0.177
K	0.0140	0.0285	0.35	0.69
L	0.0350	0.0401	0.89	1.02
S	0.0830	0.1039	2.10	2.64
V	0.0177	0.0236	0.45	0.60

- PIN 1. BASE
 2. EMITTER
 3. COLLECTOR

