

DRAWING NO SHEET MODEL NAME ISSUE  
**SPL9066 1 OF 3 ASS8800 1**

ISSUE	MODIFICATION	DRN	DATE
1	ORIGINAL ISSUE	RE	14.03.12



**Marl International Limited**  
 Marl Business Park,  
 Ulverston, Cumbria,  
 LA12 9BN, England.

tel: +44 (0)1229 582430  
 fax: +44 (0)1229 585155  
 e-mail: sales@marl.co.uk  
 website: www.marl.co.uk

**748-982-76-50**

**OVERVIEW**

THE MARL LOW PROFILE FLOOD LIGHT COMBINES THE LATEST 130Lm/W LEDS WITH HIGH-EFFICIENCY OPTICS, PSU AND OPTIMISED THERMAL DESIGN TO ACHIEVE A TOTAL LUMEN OUTPUT OF UP TO 5000 LUMENS MAKING IT THE IDEAL ANSWER TO LOW ENERGY FLOOD LIGHTING SOLUTIONS. THE ROBUST HOUSING IS POWDER COATED TO PROVIDE LONG TERM ENVIRONMENTAL PROTECTION AND IS IP SEALED TO IP66. THE FLOODLIGHT HAS BEEN DESIGNED FOR SIMPLE INSTALLATION WITH ADJUSTABLE MOUNTING BRACKET AND PRE-TERMINATED WITH UV STABILISED POWER CABLE.

EFFICIENCY OF >80Lm/W MEANS THIS PRODUCT QUALIFIES FOR ENHANCED CAPITAL ALLOWANCE (ECA) CLAIM. CONTACT SALES FOR DETAILS.

**ELECTRICAL**

INPUT POWER: 60W  
 INPUT VOLTAGE: 90-305VAC  
 FREQUENCY: 47-63Hz  
 POWER FACTOR: >0.95/230VAC  
 INRUSH CURRENT: COLD START 75A/230VAC  
 AC CURRENT: (0.8A/115VAC 0.4/230VAC)  
 PROTECTION: OVER VOLTAGE / CURRENT / TEMPERATURE & S/C  
 AMBIENT OPERATING TEMPERATURE: -30°C TO +45°C  
 STORAGE TEMPERATURE: -40°C TO +80°C  
 COMPLIANCE TO WORLDWIDE SAFETY REGULATIONS FOR LIGHTING  
 80.8Lm/W TOTAL SYSTEM EFFICIENCY - INDEPENDENTLY TESTED (SEE PAGE 3)

**OPTICAL**

VIEWING ANGLE: 100°  
 COLOUR TEMP: >5000K  
 CRI (TYP): 85.7

**MECHANICAL**

IP RATING: IP66  
 GLASS: TEMPERED  
 HOUSING: DIE-CAST ALUMINIUM POWDER COATED  
 WEIGHT: 8.1 KG  
 CABLE SPEC: PVC INSULATED PUR SHEATHED  
 3-CORE 16/0.2MM, 7.1MM OD  
 CABLE LENGTH: 2M



- **HIGH EFFICIENCY COMPONENTS USED FOR MAXIMUM ENERGY SAVING.**
- **LONG LIFE AND RELIABILITY ELIMINATE MAINTENANCE PERIOD FOR 60,000HRS (13 YRS @12 HRS PER DAY).**
- **DURABLE POWDER COATED IP66 HOUSING WITH TEMPERED GLASS.**
- **CAN REPLACE 500W LINEAR HALOGEN OR 100W METAL HALIDE**

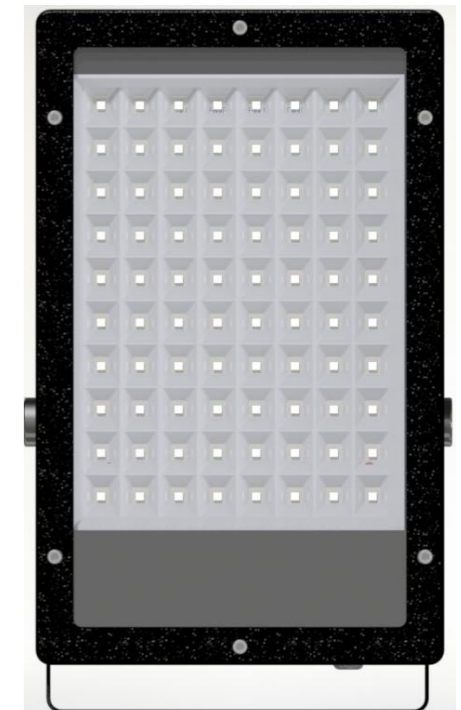

**21/03/12  
 NON-MAINTAINED  
 COPY**

TOLERANCE/ SCALE UOS		DRN: RE
LINEAR ± 0.5		DATE: 14.03.12
ANGULAR N/A		CHK1: <b>RW</b>
ORIGINAL SCALE 1:5		CHK2: <b>NJO</b>

DRAWING NO SHEET MODEL NAME ISSUE  
**SPL9066 2 OF 3 ASS8800 1**

ISSUE	MODIFICATION	DRN	DATE
1	ORIGINAL ISSUE	RE	14.03.12



**Marl International Limited**  
 Marl Business Park,  
 Ulverston, Cumbria,  
 LA12 9BN, England.

tel: +44 (0)1229 582430  
 fax: +44 (0)1229 585155  
 e-mail: sales@marl.co.uk  
 website: www.marl.co.uk

# 748-982-76-50

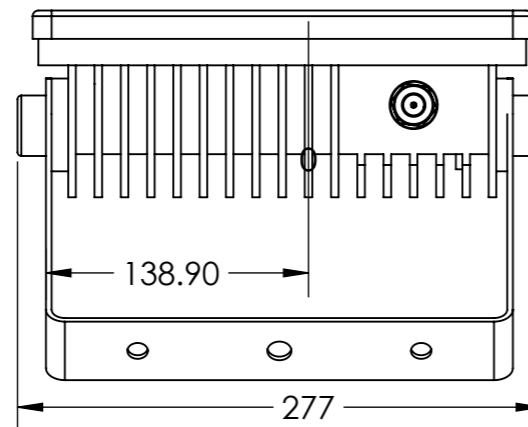
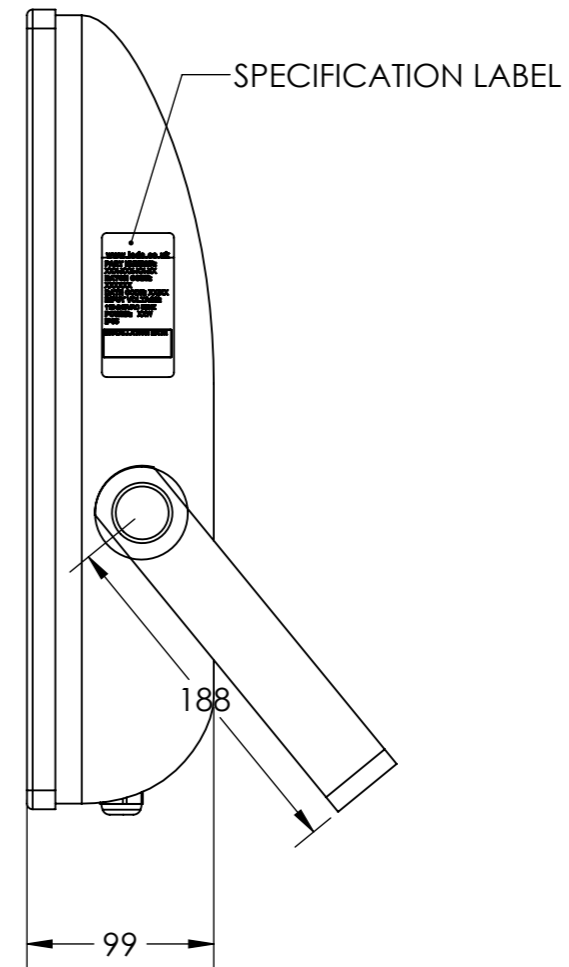
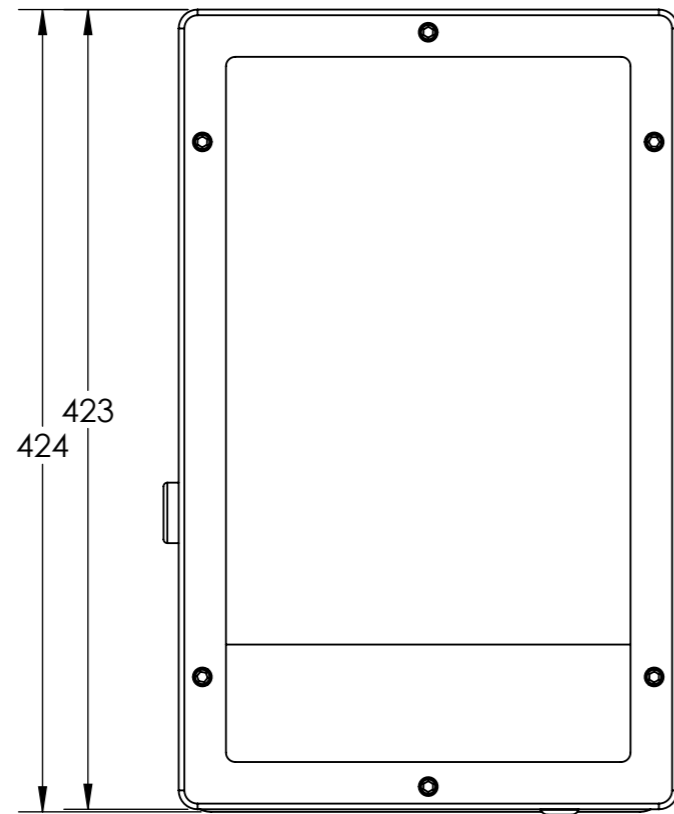

- **HIGH EFFICIENCY COMPONENTS USED FOR MAXIMUM ENERGY SAVING.**
- **LONG LIFE AND RELIABILITY ELIMINATE MAINTENANCE PERIOD FOR 60,000HRS (13 YRS @12 HRS PER DAY).**
- **DURABLE POWDER COATED IP66 HOUSING WITH TEMPERED GLASS.**
- **CAN REPLACE 500W LINEAR HALOGEN OR 100W METAL HALIDE**

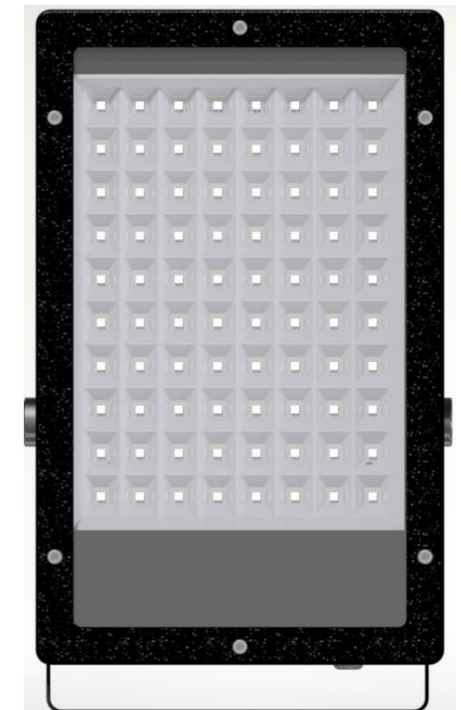

**21/03/12  
 NON-MAINTAINED  
 COPY**

TOLERANCE/ SCALE UOS  
 LINEAR ± 0.5  
 ANGULAR N/A  
 ORIGINAL SCALE 1:4

ALL DIMENSIONS  
 IN MM

DRN: RE  
 DATE: 14.03.12  
 CHK1: **RW**  
 CHK2: **NJO**

DRAWING NO SHEET MODEL NAME ISSUE  
**SPL9066 3 OF 3 ASS8800 1**

ISSUE	MODIFICATION	DRN	DATE
1	ORIGINAL ISSUE	RE	14.03.12

**21/03/12  
NON-MAINTAINED  
COPY**

## 748-982-76-50



**Marl International Limited**  
 Marl Business Park,  
 Ulverston, Cumbria,  
 LA12 9BN, England.

tel: +44 (0)1229 582430  
 fax: +44 (0)1229 585155  
 e-mail: sales@marl.co.uk  
 website: www.marl.co.uk

Average Principal Axes Luminous Intensities (cd/klm)

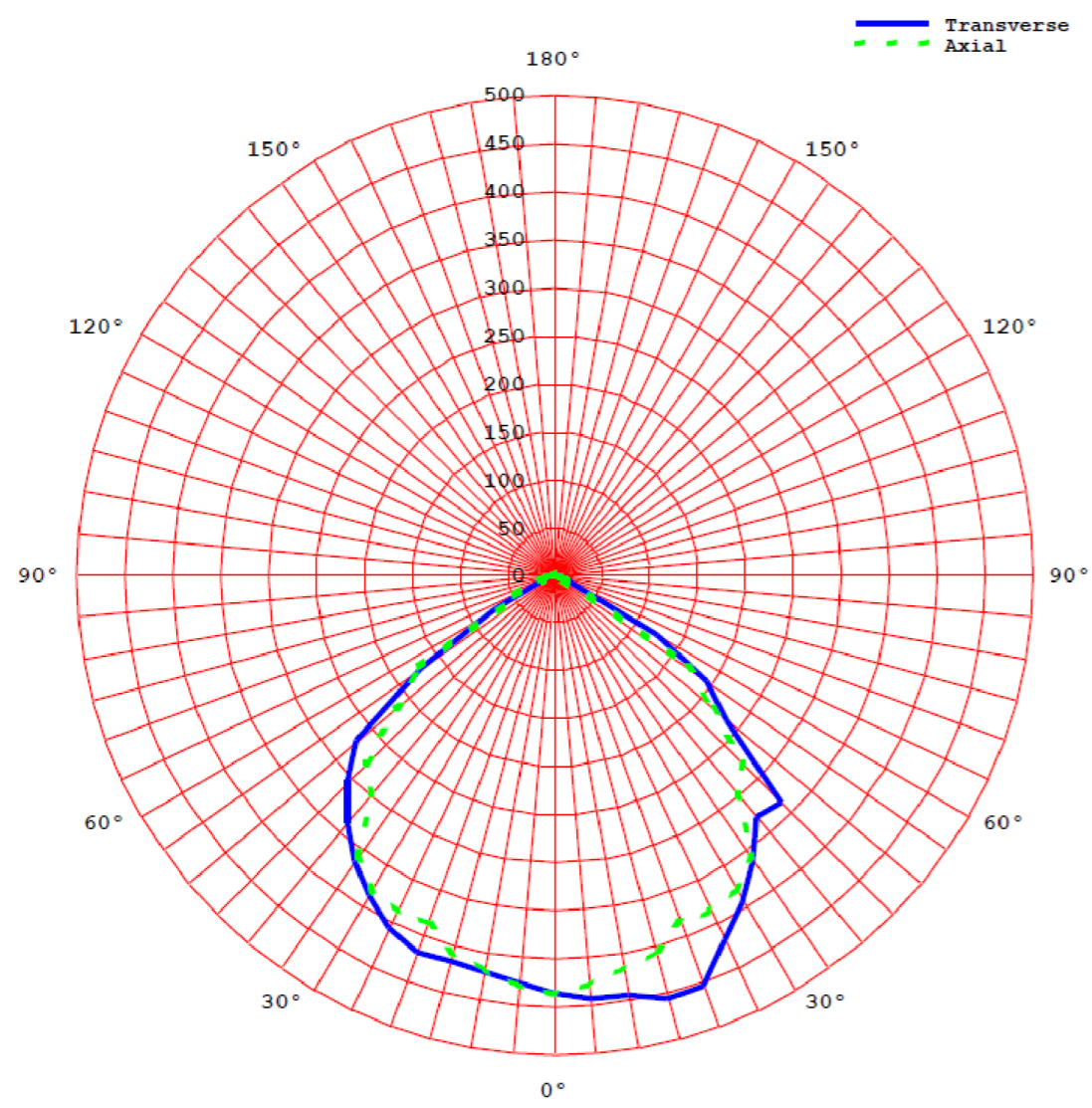

RESULTS PROVIDED BY 42 PARTNERS LTD  
 PHOTOMETRIC REPORT DATED 14.03.12  
 IES FILES AVAILABLE ON REQUEST

Job / Report / Date 42 / 10249 / 10249-1a / 2012.03.14

Customer Marl International Limited  
 Luminaire catalog No. 748-982-76-50  
 Luminaire description LED floodlight  
 Source description 80 LED array  
 Luminaire output 4,938 lm

Electrical input & Photometric output characteristics

Sample	Voltage (V)	Current (mA)	Power Factor	Power (W)	VA	Output (lm)	Efficacy (lm/W)
Luminaire	230.0	273.3	0.972	61.1	62.9	4,938	80.8

Electrical characteristics at 25°C  
 Luminaire 230V 273.3mA 0.97PF 61.1W 62.9VA

Lumen Output figures used in this report (lumens)  
 Measured Luminaire Output 4,938

Measured luminous efficacy at 25°C  
 Luminaire 80.8 lm/W

CIE Chromaticity Coordinates:  
 CIE 1931(x,y) = ( 0.3353 , 0.3113 )  
 CIE 1976(u',v') = ( 0.2211 , 0.4619 )

Correlated Color Temperature  
 CCT = 5330

Color Rendering Index  
 General CRI = 85.7

- **HIGH EFFICIENCY COMPONENTS USED FOR MAXIMUM ENERGY SAVING.**
- **LONG LIFE AND RELIABILITY ELIMINATE MAINTENANCE PERIOD FOR 60,000HRS (13 YRS @12 HRS PER DAY).**
- **DURABLE POWDER COATED IP66 HOUSING WITH TEMPERED GLASS.**
- **CAN REPLACE 500W LINEAR HALOGEN OR 100W METAL HALIDE**

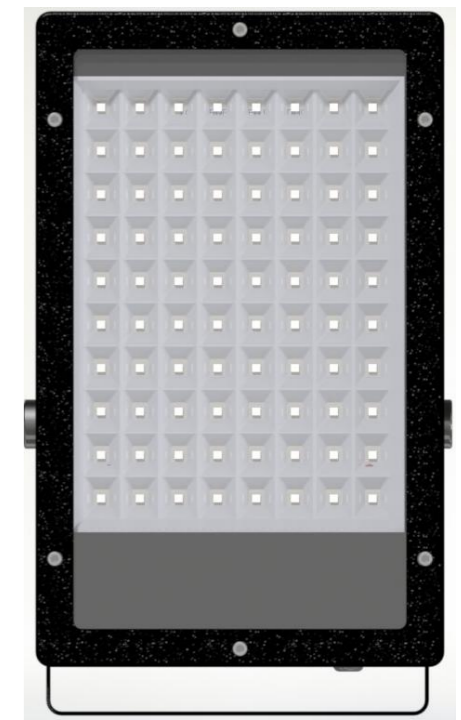

TOLERANCE/ SCALE UOS		DRN: RE
LINEAR ± 0.5		DATE: 14.03.12
ANGULAR N/A		CHK1: <b>RW</b>
ORIGINAL SCALE N/A		CHK2: <b>NJO</b>