

SPDT SWITCH GaAs MMIC

■ GENERAL DESCRIPTION

The NJG1669MD7 is a GaAs SPDT switch IC suited for WiMAX CPE and data card application. The NJG1669MD7 features low insertion loss, high power handling and high isolation.

This device exhibits wide frequency coverage up to 6.0GHz. And also this switch MMIC includes ESD protection circuits.

An ultra- small and ultra-thin package of EQFN14-D7 is adopted.

■ PACKAGE OUTLINE

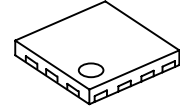

NJG1669MD7

■ FEATURES

- Control voltage +2.0V~+5.0V
 - Low insertion loss
 - 0.35dB typ. @f=2.5GHz, P_{IN}=30dBm, V_{CTL(H)}=3.0V
 - 0.40dB typ. @f=3.5GHz, P_{IN}=30dBm, V_{CTL(H)}=3.0V
 - 0.45dB typ. @f=6.0GHz, P_{IN}=30dBm, V_{CTL(H)}=3.0V
 - High isolation
 - 28dB typ. @f=2.5GHz, P_{IN}=30dBm, V_{CTL(H)}=3.0V
 - 29dB typ. @f=3.5GHz, P_{IN}=30dBm, V_{CTL(H)}=3.0V
 - 25dB typ. @f=6.0GHz, P_{IN}=30dBm, V_{CTL(H)}=3.0V
 - High P_{-0.1dB} Compression
 - 37dBm typ. @f=2.5GHz, V_{CTL(H)}=3.0V
 - 37dBm typ. @f=3.5GHz, V_{CTL(H)}=3.0V
 - Ultra- small and ultra-thin package
 - Lead-free and halogen-free
- EQFN14-D7 (package Size: 1.6 x 1.6x 0.397mm typ.)

■ PIN CONFIGURATION

EQFN14-D7 Type
(TOP VIEW)

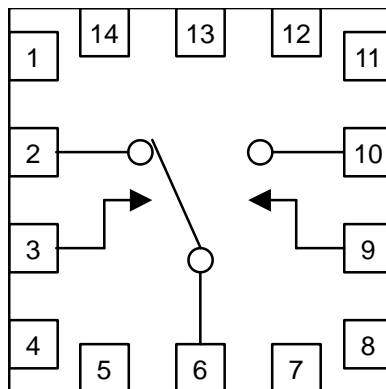

- | | |
|------------|-------------|
| 1. NC(GND) | 8. NC(GND) |
| 2. P2 | 9. CTL1 |
| 3. CTL2 | 10. P1 |
| 4. NC(GND) | 11. NC(GND) |
| 5. NC(GND) | 12. NC(GND) |
| 6. PC | 13. GND |
| 7. NC(GND) | 14. NC(GND) |

■ TRUTH TABLE

“H”=V_{CTL(H)}, “L”=V_{CTL(L)}

CTL1	CTL2	PATH
H	L	PC-P1
L	H	PC-P2

NOTE: The information on this datasheet is subject to change without notice

■ ABSOLUTE MAXIMUM RATINGS

(T_a=25°C, Z_s=Z_l=50Ω)

PARAMETER	SYMBOL	CONDITIONS	RATINGS	UNITS
RF Input power	P _{IN}	V _{CTL} =0/3V	38	dBm
Control voltage	V _{CTL}	CTL terminal	6.0	V
Power dissipation	P _D	Four-layer FR4 PCB with through-hole (74.2x74.2mm), T _j =150°C	1300	mW
Operating temperature	T _{opr}		-40~+85	°C
Storage temperature	T _{stg}		-55~+150	°C

■ ELECTRICAL CHARACTERISTICS

(General conditions: T_a=+25°C, V_{CTL(L)}=0V, V_{CTL(H)}=3V, Z_s=Z_l=50Ω)

PARAMETER	SYMBOL	CONDITIONS	MIN	TYP	MAX	UNITS
Control voltage (L)	V _{CTL(L)}		-0.2	-	0.2	V
Control voltage (H)	V _{CTL(H)}		2.0	3.0	5.0	V
Control current	I _{CTL}		-	15	30	μA
Insertion loss 1	LOSS1	f=2.5GHz	-	0.35	0.55	dB
Insertion loss 2	LOSS2	f=3.5GHz	-	0.40	0.60	dB
Insertion loss 3	LOSS3	f=6.0GHz	-	0.45	0.65	dB
Isolation 1	ISL1	f=2.5GHz	25	28	-	dB
Isolation 2	ISL2	f=3.5GHz	26	29	-	dB
Isolation 3	ISL3	f=6.0GHz	22	25	-	dB
Input power at 0.1dB compression point 1	P _{-0.1dB(1)}	f=2.5GHz	34	37	-	dBm
Input power at 0.1dB compression point 2	P _{-0.1dB(2)}	f=3.5GHz	34	37	-	dBm
VSWR	VSWR	f=3.5GHz, ON STATE	-	1.1	1.4	
2nd Harmonics 1	2f ₀₍₁₎	f=2.5GHz, P _{IN} =30dBm	-	-40	-30	dBm
2nd Harmonics 2	2f ₀₍₂₎	f=3.5GHz, P _{IN} =30dBm	-	-40	-30	dBm
3rd Harmonics 1	3f ₀₍₁₎	f=2.5GHz, P _{IN} =30dBm	-	-40	-30	dBm
3rd Harmonics 2	3f ₀₍₂₎	f=3.5GHz, P _{IN} =30dBm	-	-40	-30	dBm
Switching time	T _{SW}	50% DC to 10/90% RF	-	350	-	ns

NJG1669MD7

www.DataSheet4U.com

■ TERMINAL INFORMATION

No.	SYMBOL	DESCRIPTION
1,4,5,7,8, 11,12,14	NC (GND)	No connected terminals. Please connect these terminals with a ground plane as close as possible for good RF performance.
2	P2	RF port. This port is connected with PC port by controlling 3rd pin to $V_{CTL(H)}$ and 9th pin to $V_{CTL(L)}$. An external capacitor is required to block the DC bias voltage of internal circuit.
3	CTL2	Control signal input terminal. Please connect a bypass capacitor (10pF) with a ground plane for avoiding RF noise from outside.
6	PC	Common RF port. An external capacitor is required to block the DC bias voltage of internal circuit.
9	CTL1	Control signal input terminal. Please connect a bypass capacitor (10pF) with a ground plane for avoiding RF noise from outside.
10	P1	RF port. This port is connected with PC port by controlling 3rd pin to $V_{CTL(L)}$ and 9th pin to $V_{CTL(H)}$. An external capacitor is required to block the DC bias voltage of internal circuit.
13	GND	Ground terminal. Please connect this terminal with a ground plane as close as possible for good RF performance.

■ **ELECTRICAL CHARACTERISTICS** (With Application circuit, Loss of external circuit are excluded)

Loss, ISL vs. Frequency

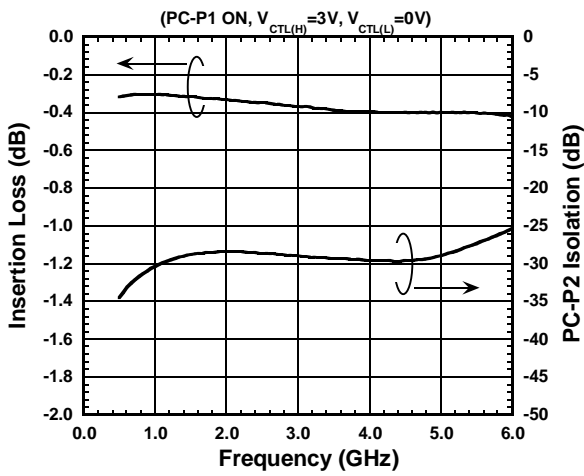

Loss, ISL vs. Frequency

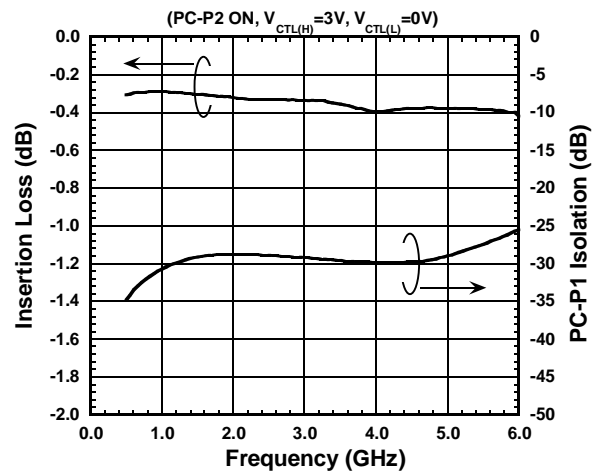

VSWR vs. Frequency

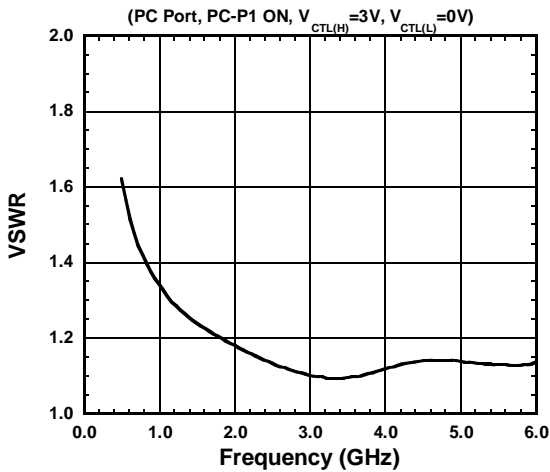

VSWR vs. Frequency

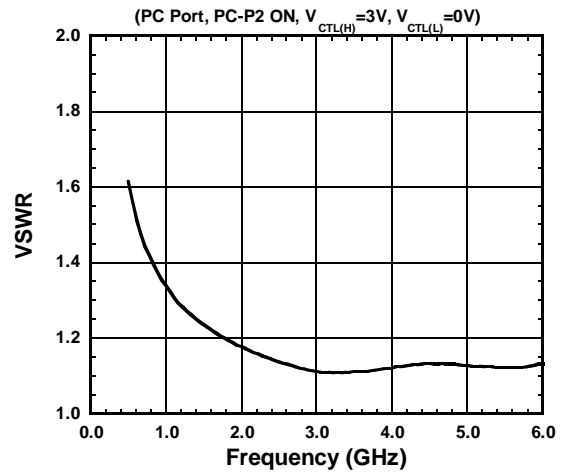

NJG1669MD7

www.DataSheet4U.com

ELECTRICAL CHARACTERISTICS (With Application circuit, Loss of external circuit are excluded)

Output Power, I_{CTL} vs. Input Power

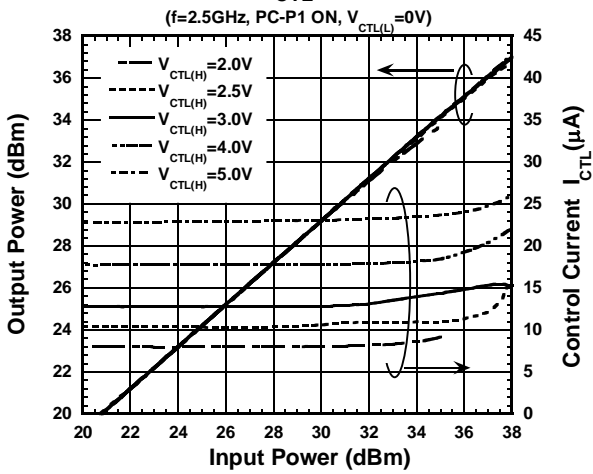

Output Power, I_{CTL} vs. Input Power

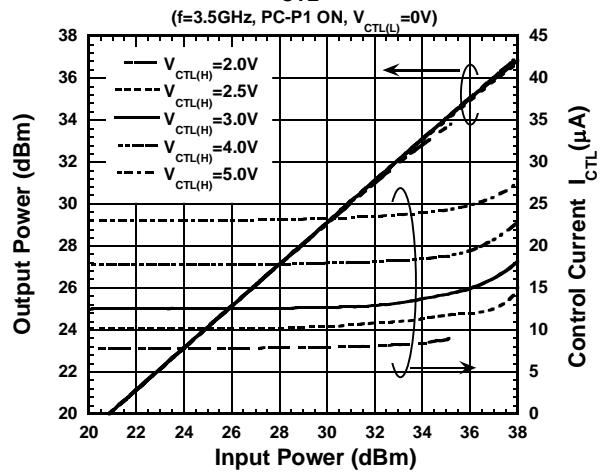

Loss, ISL vs. Input Power

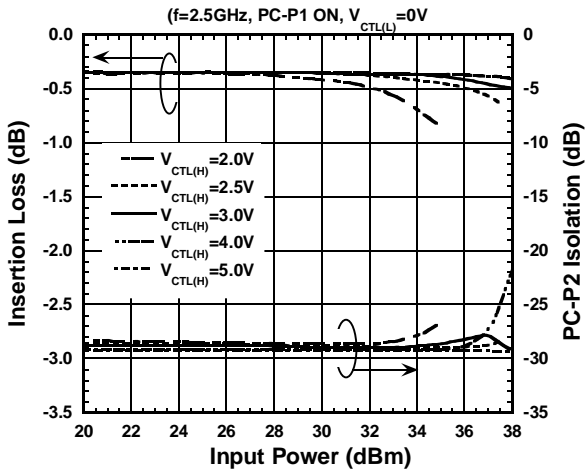

Loss, ISL vs. Input Power

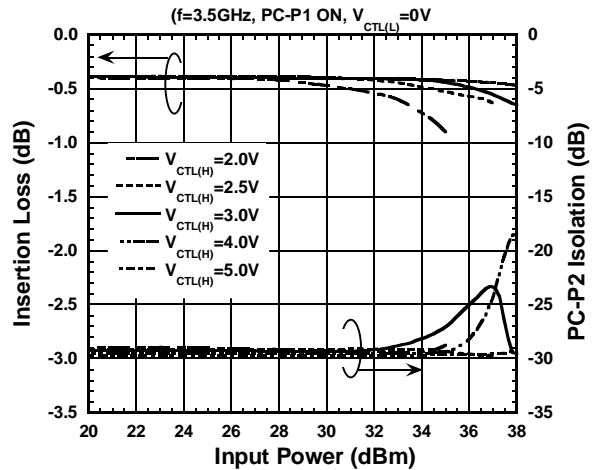

■ ELECTRICAL CHARACTERISTICS (With Application circuit, Loss of external circuit are excluded)

2nd Harmonics vs. Input Power

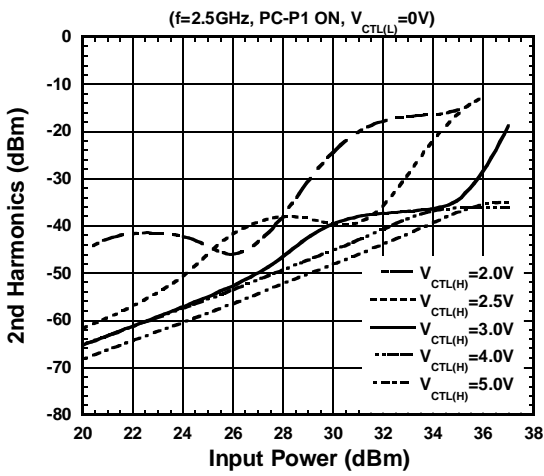

2nd Harmonics vs. Input Power

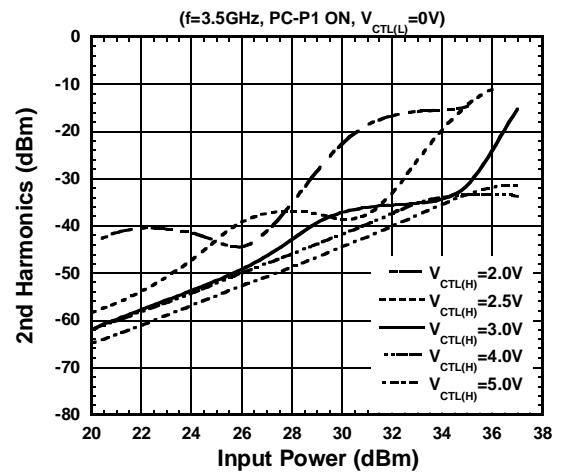

3rd Harmonics vs. Input Power

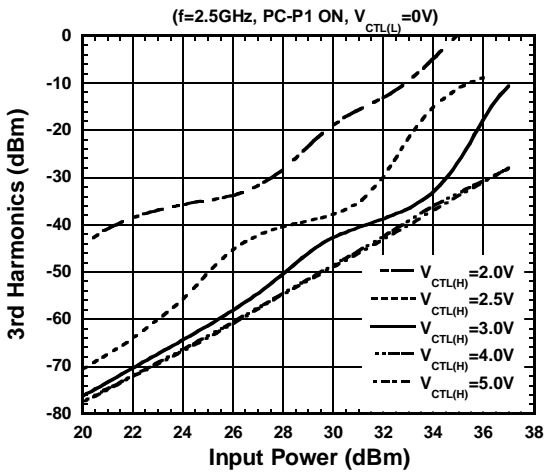

3rd Harmonics vs. Input Power

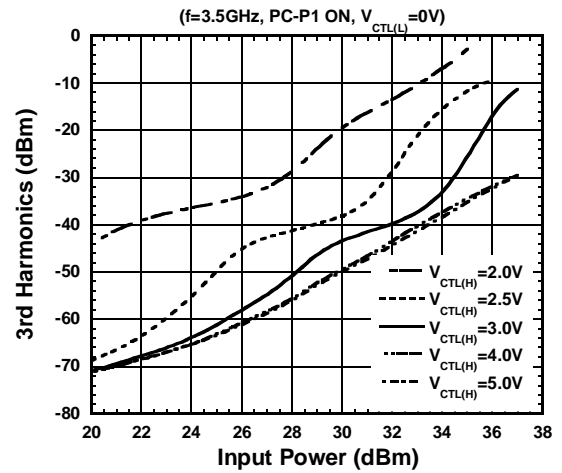

Switching Time

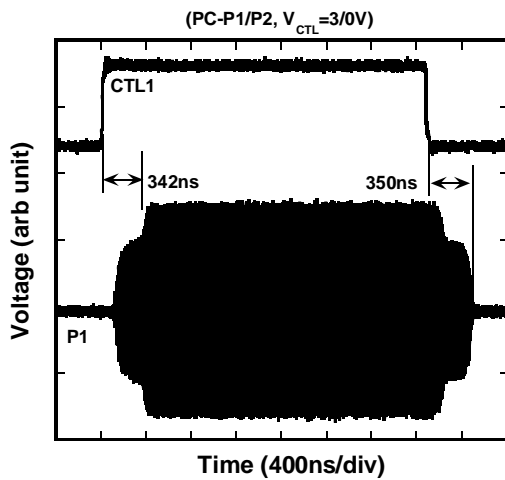

NJG1669MD7

www.DataSheet4U.com

ELECTRICAL CHARACTERISTICS (With Application circuit, Loss of external circuit are excluded)

Loss, ISL vs. Ambient Temperature

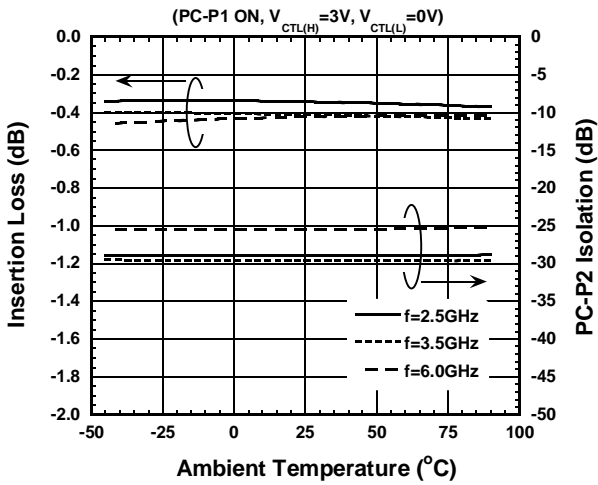

VSWR vs. Ambient Temperature

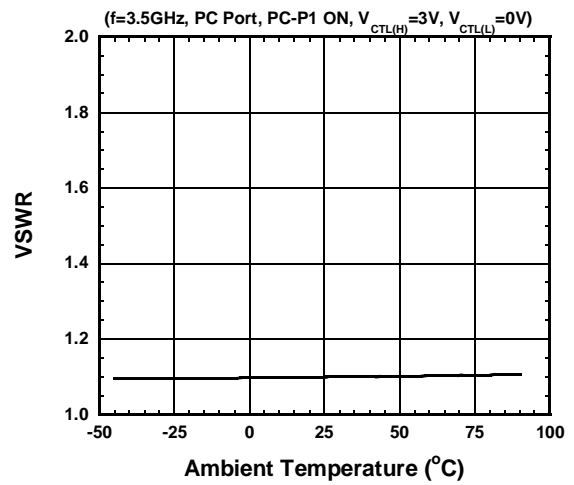

I_{CTL} vs. Ambient Temperature

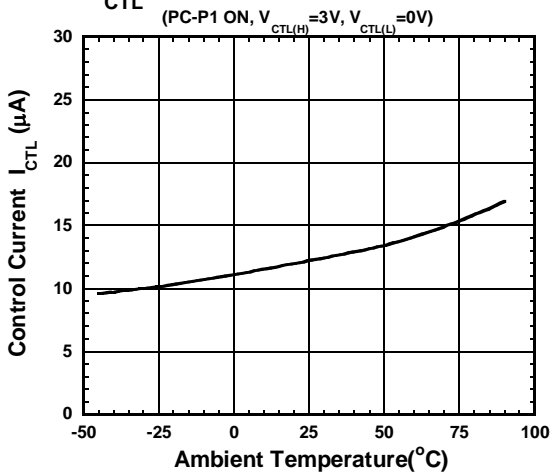

P_{-0.1dB} vs. Ambient Temperature

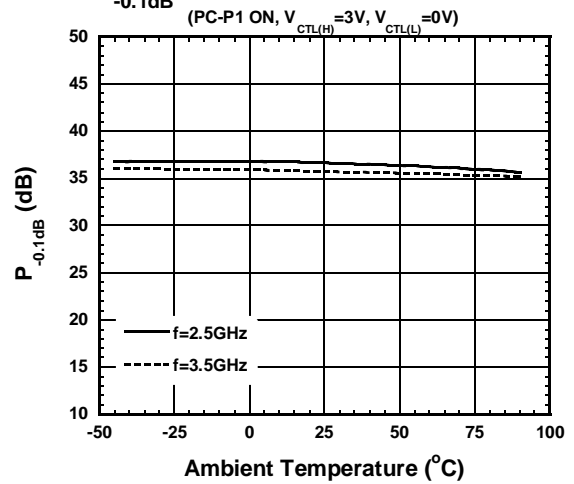

2nd Harmonics vs. Ambient Temperature

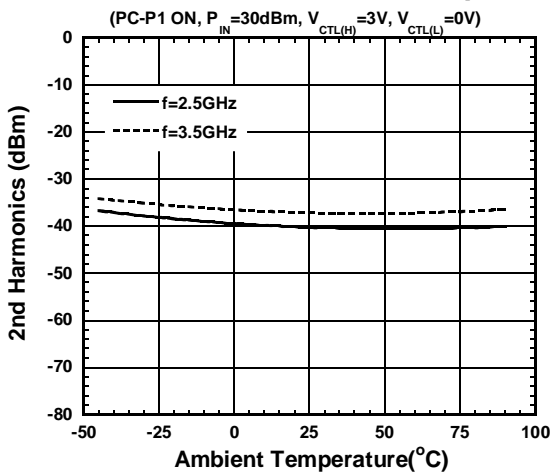

3rd Harmonics vs. Ambient Temperature

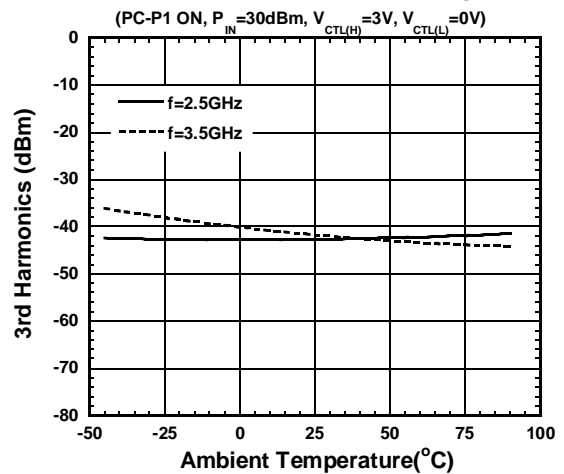

APPLICATION CIRCUIT

(TOP VIEW)

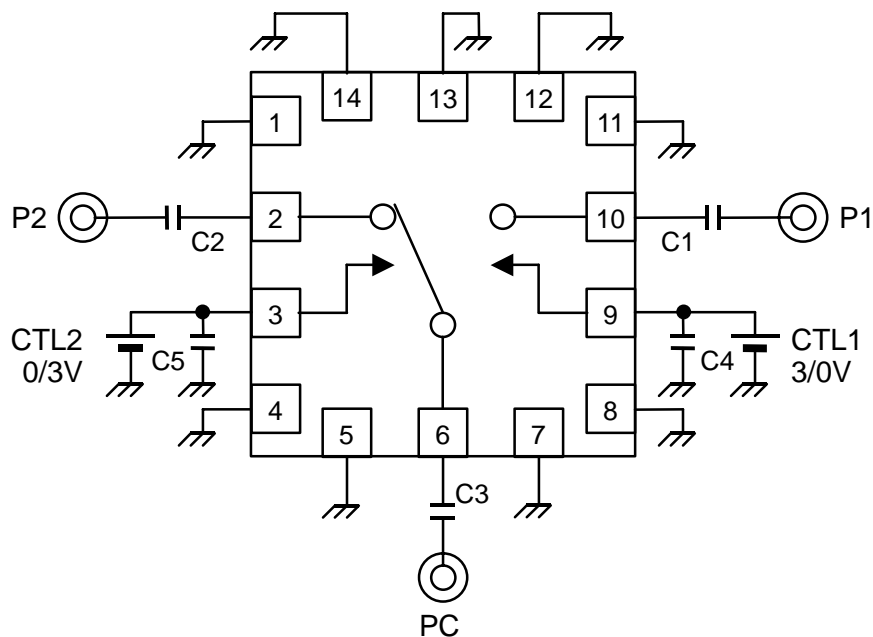

TEST PCB LAYOUT

(Top View)

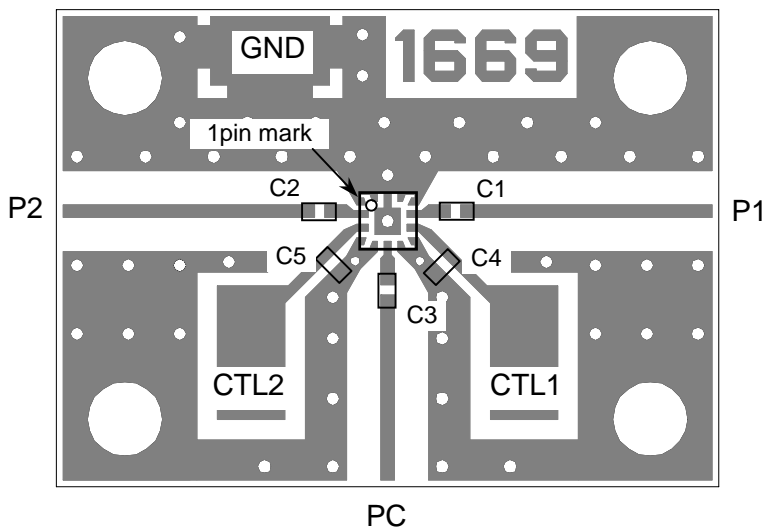

PCB: FR-4, t=0.2mm
 Capacitor size: 1005
 Strip Line Width: 0.4mm
 PCB size: 19.4 x 14.0mm

Losses of PCB, capacitors and connectors

Frequency (GHz)	Loss (dB)
2.5	0.37
3.5	0.45
6.0	0.71

PARTS LIST

Parts ID	Value	Notes
C1~C3	27pF	Murata MFG (GRM15)
C4, C5	10pF	

PRECAUTIONS

- [1] The DC blocking capacitors have to be placed at RF terminal of P1, P2 and PC.
Please choose appropriate capacitance values to the application frequency.
- [2] For avoiding the degradation of RF performance, please place bypass capacitors (C4 and C5) as close as possible to each terminal.
- [3] For good RF performance, the GND terminals must be connected with the ground plane of substrate, and through - holes for GND should be placed the IC near.

NJG1669MD7

www.DataSheet4U.com

PACKAGE OUTLINE (EQFN14-D7)

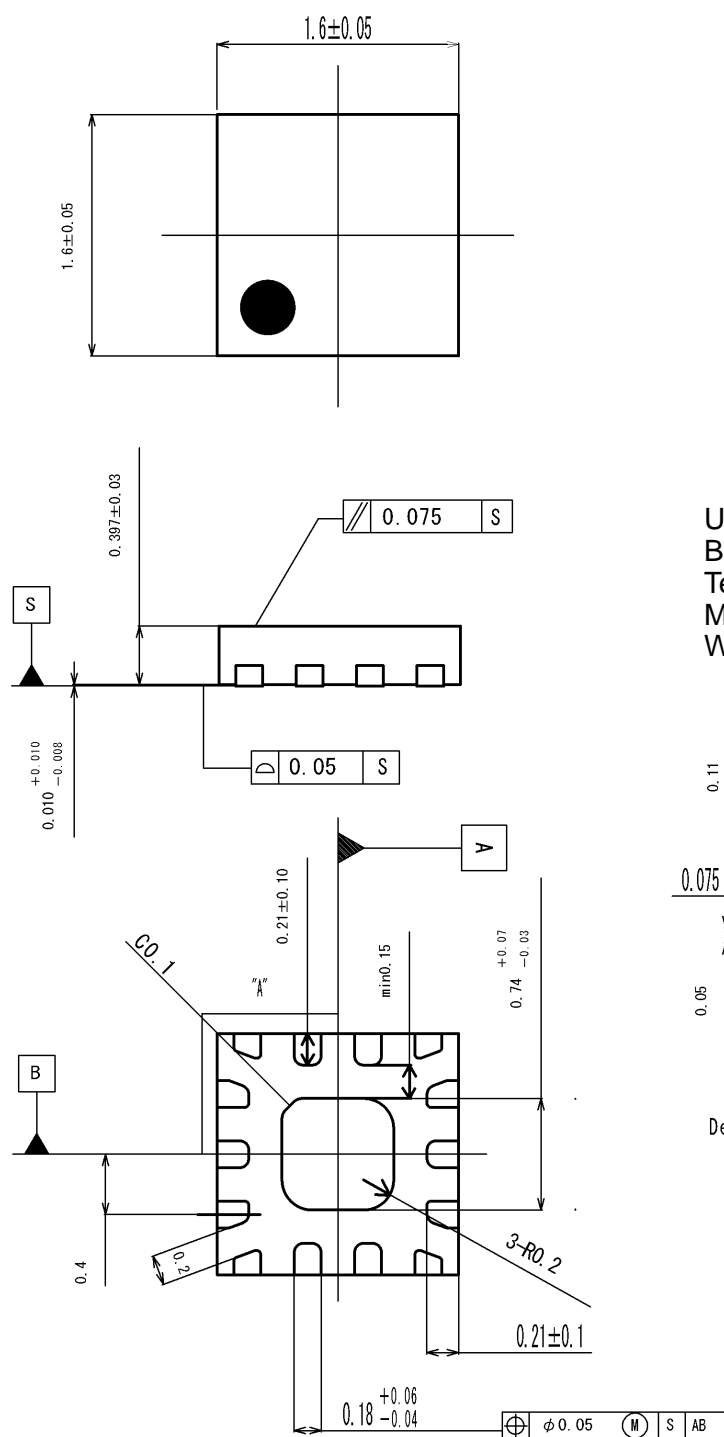

Units : mm
 Board : Cu
 Terminal treat : SnBi
 Molding material : Epoxy resin
 Weight : 3.3mg

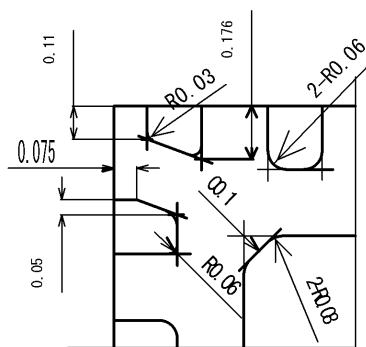

Details of "A" part (x2)

Cautions on using this product

This product contains Gallium-Arsenide (GaAs) which is a harmful material.

- Do NOT eat or put into mouth.
- Do NOT dispose in fire or break up this product.
- Do NOT chemically make gas or powder with this product.
- To waste this product, please obey the relating law of your country.

[CAUTION]

The specifications on this databook are only given for information, without any guarantee as regards either mistakes or omissions. The application circuits in this databook are described only to show representative usages of the product and not intended for the guarantee or permission of any right including the industrial rights.

This product may be damaged with electric static discharge (ESD) or spike voltage. Please handle with care to avoid these damages.