

**PRODUCT SUMMARY**

# SKY77702 Power Amplifier Module for WCDMA / HSDPA / HSUPA / HSPA+ / LTE – Band II (1850–1910 MHz)

**Applications**

- WCDMA handsets
- HSDPA
- HSUPA
- HSPA+
- LTE

**Features**

- Low voltage positive bias supply 3.2 V to 4.2 V
- Good linearity
- High efficiency
  - 40% @ 28.6 dBm
- Large dynamic range
- Small, low profile package
  - 3 mm x 3 mm x 0.9 mm
  - 10-pad configuration
- Power down control
- InGaP
- Supports low collector voltage operation
- Digital Enable
- No V<sub>REF</sub> required
- CMOS compatible control signals
- Integrated Directional Coupler

**Description**

The SKY77702 Power Amplifier Module (PAM) is a fully matched 10-pad surface mount module developed for Wideband Code Division Multiple Access (WCDMA) applications. This small and efficient module packs full 1850–1910 MHz bandwidth coverage into a single compact package. Because of high efficiencies attained throughout the entire power range, the SKY77702 delivers unsurpassed talk-time advantages. The SKY77702 meets the stringent spectral linearity requirements of High Speed Downlink Packet Access (HSDPA), High Speed Uplink Packet Access (HSUPA), and Long Term Evolution (LTE) data transmission with high power added efficiency. A directional coupler is integrated into the module thus eliminating the need for any external coupler.

The single Gallium Arsenide (GaAs) Microwave Monolithic Integrated Circuit (MMIC) contains all active circuitry in the module. The MMIC contains on-board bias circuitry, as well as input and interstage matching circuits. Output match into a 50-ohm load is realized off-chip within the module package to optimize efficiency and power performance.

The SKY77702 PAM is manufactured with Skyworks' InGaP GaAs Heterojunction Bipolar Transistor (HBT) BiFET process that provides for all positive voltage DC supply operation while maintaining high efficiency and good linearity. Primary bias to the SKY77702 is supplied directly from any three-cell Ni-Cd, a single-cell Li-Ion, or other suitable battery with an output in the 3.2 to 4.2 volt range. No V<sub>REF</sub> voltage is required. Power down is accomplished by setting the voltage on VENABLE to zero volts. No external supply side switch is needed as typical "off" leakage is a few microamperes with full primary voltage supplied from the battery.

**NEW** Skyworks Green™ products are RoHS (Restriction of Hazardous Substances)-compliant, conform to the EIA/EICTA/JEITA Joint Industry Guide (JIG) Level A guidelines, are halogen free according to IEC-61249-2-21, and contain < 1,000 ppm antimony trioxide in polymeric materials.

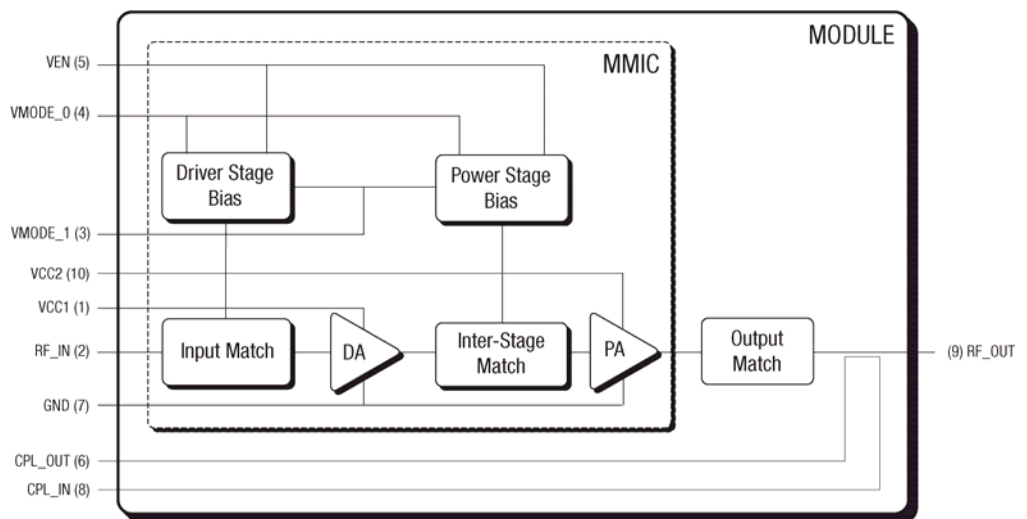
**Figure 1. SKY77702 Functional Block Diagram**

Copyright © 2010, Skyworks Solutions, Inc. All Rights Reserved.

Information in this document is provided in connection with Skyworks Solutions, Inc. ("Skyworks") products. These materials are provided by Skyworks as a service to its customers and may be used for informational purposes only by the customer. Skyworks assumes no responsibility for errors or omissions in these materials. Skyworks may make changes to its documentation, products, specifications and product descriptions at any time, without notice. Skyworks makes no commitment to update the information and shall have no responsibility whatsoever for conflicts, incompatibilities, or other difficulties arising from future changes to its documentation, products, specifications and product descriptions.

No license, express or implied, by estoppel or otherwise, to any intellectual property rights is granted by or under this document. Except as may be provided in Skyworks' Terms and Conditions of Sale for such products, Skyworks assumes no liability whatsoever in association with its documentation, products, specifications and product descriptions.

THESE MATERIALS ARE PROVIDED "AS IS" WITHOUT WARRANTY OF ANY KIND, EITHER EXPRESS OR IMPLIED OR OTHERWISE, RELATING TO SALE AND/OR USE OF SKYWORKS PRODUCTS INCLUDING WARRANTIES RELATING TO FITNESS FOR A PARTICULAR PURPOSE, MERCHANTABILITY, PERFORMANCE, QUALITY OR NON-INFRINGEMENT OF ANY PATENT, COPYRIGHT OR OTHER INTELLECTUAL PROPERTY RIGHT. SKYWORKS FURTHER DOES NOT WARRANT THE ACCURACY OR COMPLETENESS OF THE INFORMATION, TEXT, GRAPHICS OR OTHER ITEMS CONTAINED WITHIN THESE MATERIALS. SKYWORKS SHALL NOT BE LIABLE FOR ANY DAMAGES, INCLUDING SPECIAL, INDIRECT, INCIDENTAL, OR CONSEQUENTIAL DAMAGES, INCLUDING WITHOUT LIMITATION, LOST REVENUES OR LOST PROFITS THAT MAY RESULT FROM THE USE OF THESE MATERIALS WHETHER OR NOT THE RECIPIENT OF MATERIALS HAS BEEN ADVISED OF THE POSSIBILITY OF SUCH DAMAGE.

Skyworks products are not intended for use in medical, lifesaving or life-sustaining applications. Skyworks' customers using or selling Skyworks products for use in such applications do so at their own risk and agree to fully indemnify Skyworks for any damages resulting from such improper use or sale.

The following are trademarks of Skyworks Solutions, Inc.: Skyworks®, the Skyworks logo®, and Breakthrough Simplicity®. Product names or services listed in this publication are for identification purposes only, and may be trademarks of Skyworks or other third parties. Third-party brands and names are the property of their respective owners. Additional information, posted at [www.skyworksinc.com](http://www.skyworksinc.com), is incorporated by reference.