

Small Signal Diode

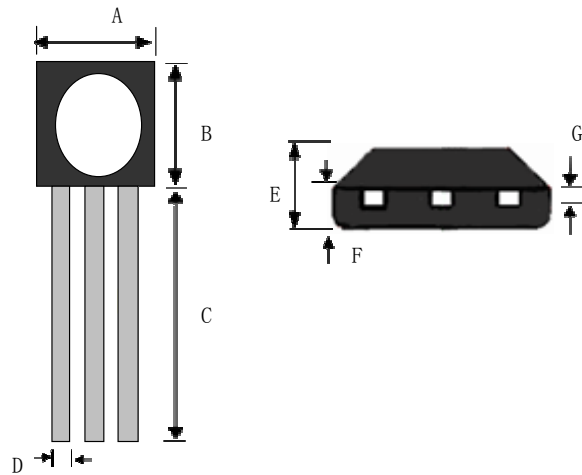

DO-92



Features

- ✦ Epitaxial planar die construction
- ✦ Surface device type mounting
- ✦ Moisture sensitivity level 1
- ✦ Matte Tin(Sn) lead finish with Nickel(Ni) underplate
- ✦ Pb free version and RoHS compliant
- ✦ Green compound (Halogen free) with suffix "G" on packing code and prefix "G" on date code

Mechanical Data

- ✦ Case : TO-92 plastic package
- ✦ Terminal: Matte tin plated, lead free., solderable per MIL-STD-202, Method 208 guaranteed
- ✦ Weight : 0.19gram (approximately)
- ✦ High temperature soldering guaranteed: 260°C/10s

Ordering Information

Package	Part No.	Packing
TO-92	MCR100-3 A1/A1G	4k/ box
TO-92	MCR100-4 A1/A1G	4k/ box
TO-92	MCR100-5 A1/A1G	4k/ box
TO-92	MCR100-6 A1/A1G	4k/ box
TO-92	MCR100-7 A1/A1G	4k/ box
TO-92	MCR100-8 A1/A1G	4k/ box

Dimensions	Unit (mm)		Unit (inch)	
	Min	Max	Min	Max
A	4.50	4.70	0.177	0.185
B	4.50	4.70	0.177	0.185
C	12.50		0.492	
D	0.35	0.45	0.013	0.017
E	3.50	3.70	0.137	0.145
F	1.00	1.20	0.039	0.047
G	0.29	0.39	0.011	0.015

Maximum Ratings and Electrical Characteristics

Rating at 25°C ambient temperature unless otherwise specified.

Maximum Ratings

Type Number	Symbol	Value	Units
Forward Current RMS(All Conduction Angles)	$I_{T(RMS)}$	0.8	A
Peak Repetitive Forward and Reverse Blocking Voltage ($T_J=25^\circ\text{C}$, $T_O=125^\circ\text{C}$, $R_{GK}=1\text{K}\Omega$)	V_{DRM} and V_{RRM}	100 200 300 400 500 600	V
Peak Forward Surge Current, $T_A=25^\circ\text{C}$ (1/2 Cycle, Sine Wave, 60Hz)	I_{TSM}	10	A
Circuit Fusing Considerations ($t=8.3$ ms)	I^2t	0.415	A^2s
Forward Peak Gate Power ($T_A=25^\circ\text{C}$, $PW \leq 1$ us)	P_{GM}	0.1	W
Forward Average Gate Power ($T_A=25^\circ\text{C}$)	$P_{GF(AV)}$	0.01	W
Forward Peak Gate Current ($T_A=25^\circ\text{C}$, $PW \leq 1$ us)	I_{GFM}	1	A
Reverse Peak Gate Current ($T_A=25^\circ\text{C}$, $PW \leq 1$ us)	V_{GRM}	5	V

Notes:1. Valid provided that electrodes are kept at ambient temperature

Small Signal Diode

Electrical Characteristics $T_a=25^\circ\text{C}$

Type Number	Symbol	Min	Max	Units
Peak Forward or Reverse Blocking Current at $V_{AK} = \text{Rated } V_{DRM} \text{ or } V_{RRM}$	I_{DRM}, I_{RRM}	-	10	μA
Peak Forward On-State Voltage at $I_{TM}=1\text{A Peak}, T_A=25^\circ\text{C}$	V_{TM}	-	1.7	V
Gate Trigger Current (Continuous dc) at Anode Voltage = 7 Vdc., $R_L=100\Omega$	I_{GT}	-	200	μA
Gate Trigger Current (Continuous dc) at Anode Voltage = 7 Vdc., $R_L=100\Omega$ at Anode Voltage = Rated $V_{DRM}, R_L=100\Omega$	V_{GT}	-	0.8	V
Holding Current at Anode Voltage = 7 Vdc., initiating current = 20mA	I_H	-	5	mA

Rating and Characteristic Curves

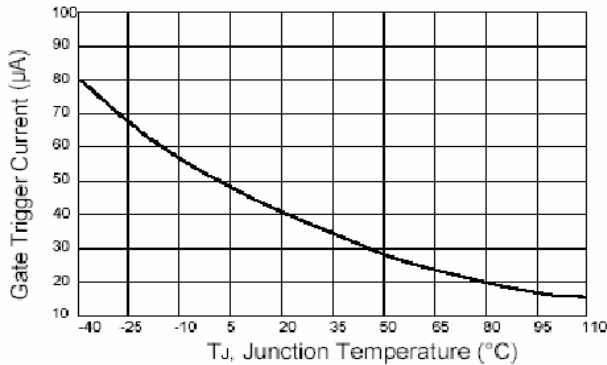

Figure 1. Typical Gate Trigger Current Versus Junction Temperature

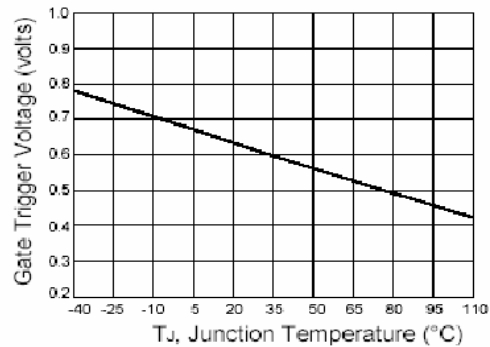

Figure 2. Typical Gate Trigger Voltage Versus Junction Temperature

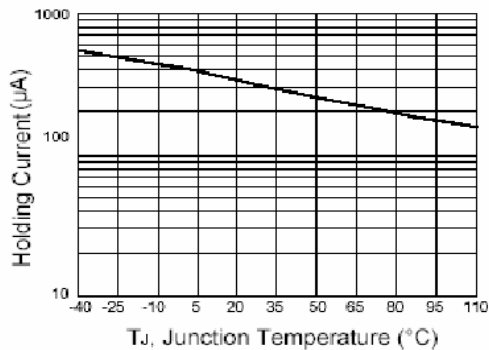

Figure 3. Typical Holding Current Versus Junction Temperature

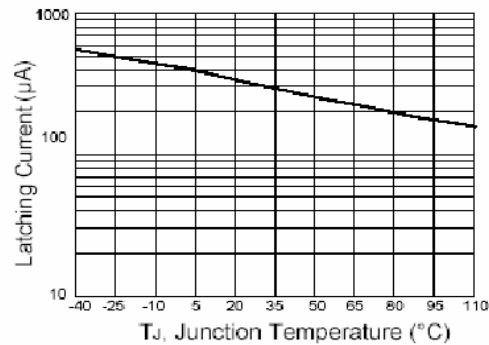

Figure 4. Typical Latching Current Versus Junction Temperature

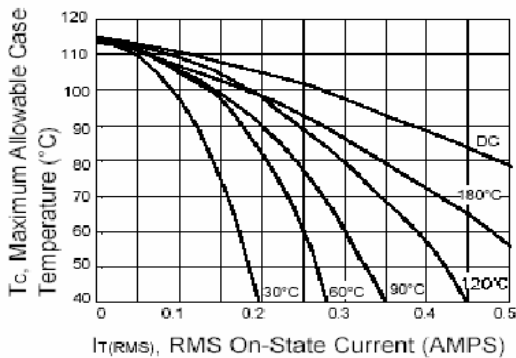

Figure 5. Typical RMS Current Derating

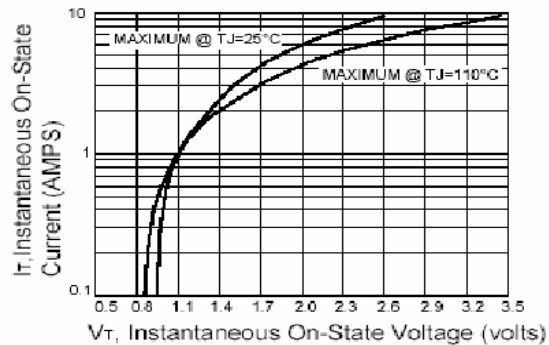

Figure 6. Typical On-State Characteristics

Small Signal Diode

Tape & Reel specification

