



# Magnetics for LM258x Flyback Regulator

These standard flyback regulator transformers are designed for use with National Semiconductor LM2585, LM2586, LM2587 and LM2588 **SIMPLE SWITCHER**® switching regulators.

They are available in surface mount and through hole configurations. All feature 500 V isolation between windings and a variety of available turns ratios.

Ref. number	Part number	Input voltage (V)	Inductance at 0 Adc ±15% (µH)	Inductance at Ipk min (µH)	Volt-time product max (Vµsec)	Leakage Inductance <sup>1</sup> max (µH)	DCR (Ohms)		Turns ratio pri : sec	Output	Ipk <sup>2</sup> (A)
							pri	sec			
T1 (SM)	Q4435-BL	4 – 6	22	19.0	166.5	0.7	0.020	0.025	1 : 1	5 V, 1.6 A	4.85
T1 (PC)	Q4434-BL	4 – 6	22	19.8	162.0	2.0	0.028	0.028	1 : 1	5 V, 1.6 A	5.0
T2 (SM)	Q4436-BL	4 – 6	22	17.6	166.5	0.5	0.025	0.23 (10-11) 0.25 (9-8)	1 : 2.5 1 : 2.5	12 V, 0.35 A 12 V, 0.35 A	5.0
T2 (PC)	Q4337-BL	4 – 6	22	19.8	162.0	2.0	0.030	0.32 (8-7) 0.32 (6-5)	1 : 2.5 1 : 2.5	12 V, 0.35 A 12 V, 0.35 A	5.0
T3 (PC)	Q4343-BL	18 – 36	85	76.5	364.5	3.5	0.150	0.011 (10-9) 0.011 (7-6)	1 : 0.8 1 : 0.8	12 V, 1.4 A 12 V, 1.4 A	3.0
T4 (PC)	Q4344-BL	18 – 36	85	76.5	364.5	3.5	0.145	0.20 (10-9) 0.20 (7-6) 0.03 (4-5)	1 : 0.8 1 : 0.8 1 : 0.35	12 V, 0.75 A 12 V, 0.75 A 5 V, 3.0 A	3.0
T5 (SM)	Q4437-BL	18 – 36	55	47.3	299.7	2.0	0.110	0.035 (10-11) 0.30 (9-8) 0.32 (4-5)	1 : 0.5 1 : 1.167 1 : 1.167	5 V, 1.8 A 12 V, 0.25 A 12 V, 0.25 A	3.0
T5 (PC)	Q4338-BL	18 – 36	66	59.4	499.5	3.5	0.090	0.039 (8-7) 0.58 (6-5) 0.60 (3-4)	1 : 0.5 1 : 1.167 1 : 1.167	5 V, 1.8 A 12 V, 0.25 A 12 V, 0.25 A	3.0
T6 (SM)	Q4438-BL	18 – 36	65	57.0	299.7	3.0	0.065	0.15 (10-11) 0.15 (9-8)	1 : 1.2 1 : 1.2	12 V, 0.63 A 12 V, 0.63 A	3.0
T6 (PC)	Q4339-BL	18 – 36	66	59.4	499.5	3.0	0.090	0.20 (8-7) 0.24 (5-6)	1 : 1.2 1 : 1.2	12 V, 0.63 A 12 V, 0.63 A	3.0
T7 (SM)	S6057-AL	4 – 6	47	40.0	233.1	2.0	0.065	0.065	1 : 1	5 V, 0.9 A	3.0
T7 (PC)	S6000-AL	4 – 6	47	40.0	212.6	2.0	0.065	0.042	1 : 1	5 V, 0.9 A	3.0

1. Leakage inductance measured across the primary at 0.10 Vrms, 100 kHz.

2. DC current at which the primary inductance is measured.

3. Electrical specifications at 25° C.

Refer to Doc 362 "Soldering Surface Mount Components" before soldering.

**Core material** Ferrite

**Ambient temperature** –40°C to +85°C

**Weight**

<b>Q4337-BL:</b>	11.4 g	<b>Q4435-BL:</b>	9.0 g
<b>Q4338-BL:</b>	11.5 g	<b>Q4436-BL:</b>	8.7 g
<b>Q4339-BL:</b>	11.6 g	<b>Q4437-BL:</b>	8.2 g
<b>Q4343-BL:</b>	25.1 g	<b>Q4438-BL:</b>	8.6 g
<b>Q4344-BL:</b>	23.1 g	<b>S6000-AL:</b>	10.6 g
<b>Q4434-BL:</b>	11.5 g	<b>S6057-AL:</b>	8.2 g

**Storage temperature** Component: –40°C to +85°C.

Packaging: –40°C to +80°C

**Resistance to soldering heat (SM parts)** Max three 40 second reflows at +260°C, parts cooled to room temperature between cycles

**Moisture Sensitivity Level (MSL)** 1 (unlimited floor life at <30°C / 85% relative humidity)

**Mean Time Between Failures (MTBF)** 26,315,789 hours

**PCB washing** Only pure water or alcohol recommended

**Coilcraft**®

Specifications subject to change without notice.  
Please check our website for latest information.

Document 183-1 Revised 10/31/08

1102 Silver Lake Road Cary, Illinois 60013 Phone 847/639-6400 Fax 847/639-1469

E-mail [info@coilcraft.com](mailto:info@coilcraft.com) Web <http://www.coilcraft.com>



# Magnetics for LM258x Flyback Regulator

## Schematics – Surface Mount (SM)

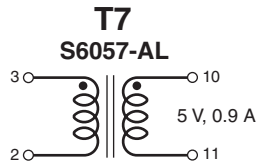
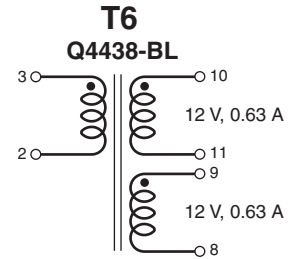
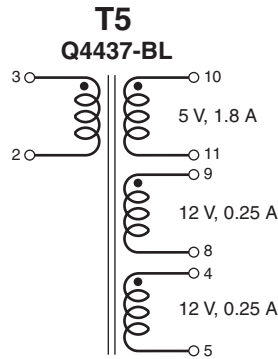
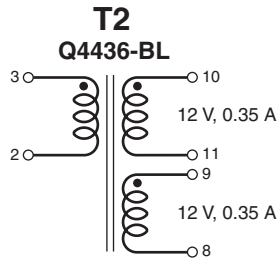
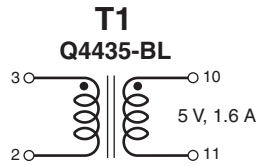

## Schematics – Leaded (PC)

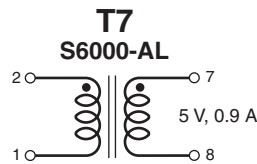
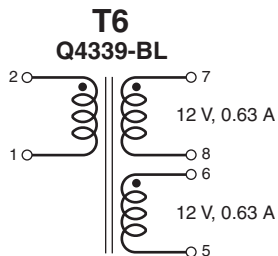
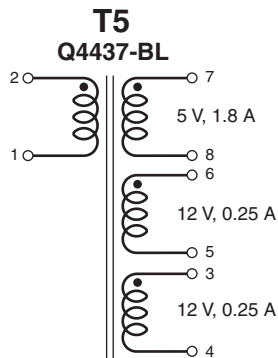
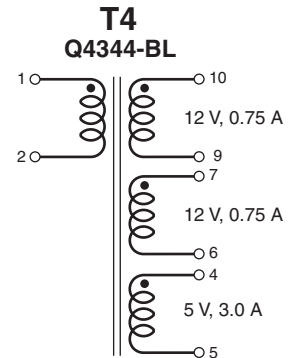
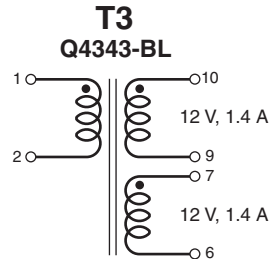
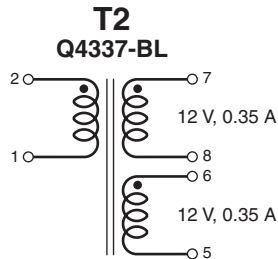
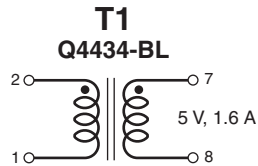

Specifications subject to change without notice.  
Please check our website for latest information.

Document 183-2 Revised 10/31/08

1102 Silver Lake Road Cary, Illinois 60013 Phone 847/639-6400 Fax 847/639-1469

E-mail [info@coilcraft.com](mailto:info@coilcraft.com) Web <http://www.coilcraft.com>



# Magnetics for LM258x Flyback Regulator

## Surface Mount (Q4435-BL, Q4436-BL, Q4437-BL, Q4438-BL, S6057-AL)

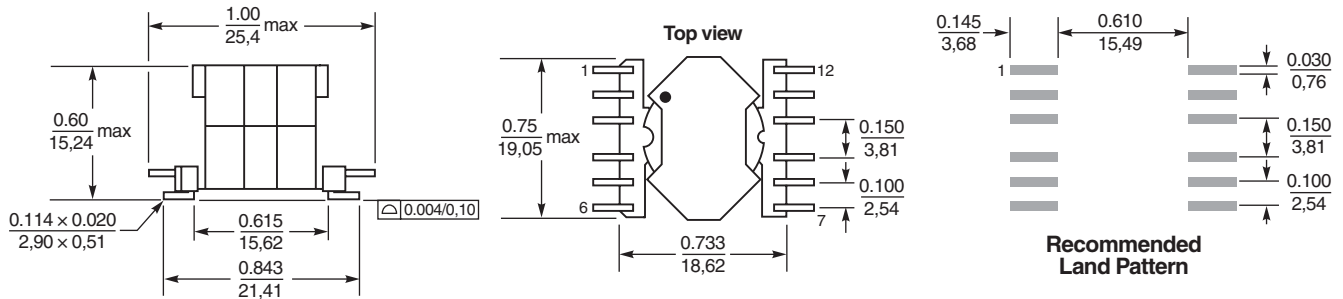

**Terminations** RoHS tin-silver over tin over nickel over phos bronze.  
Packaged 81 parts per tray

## Leaded – T1, T2, T5, T6, T7 (Q4434-BL, Q4337-BL, Q4338-BL, Q4339-BL, S6000-AL)

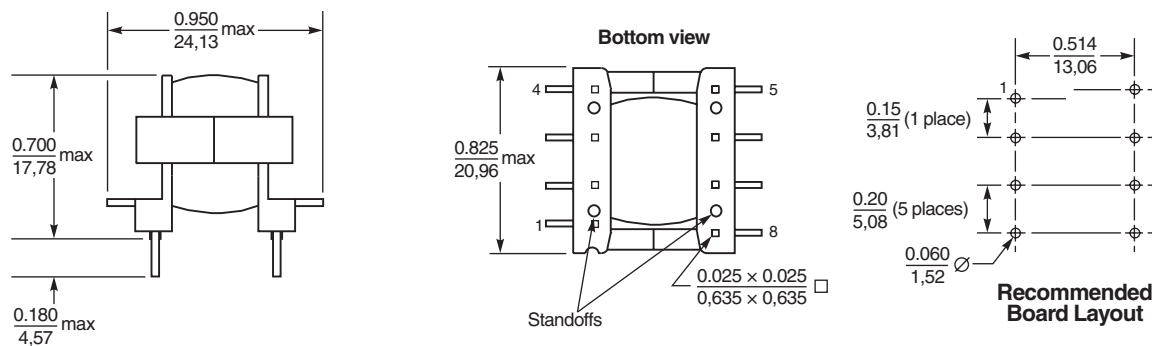

**Terminations** RoHS tin-silver over tin over nickel over phos bronze.  
Packaged 49 parts per tray

## Leaded – T3, T4 (Q4343-BL, Q4344-BL)

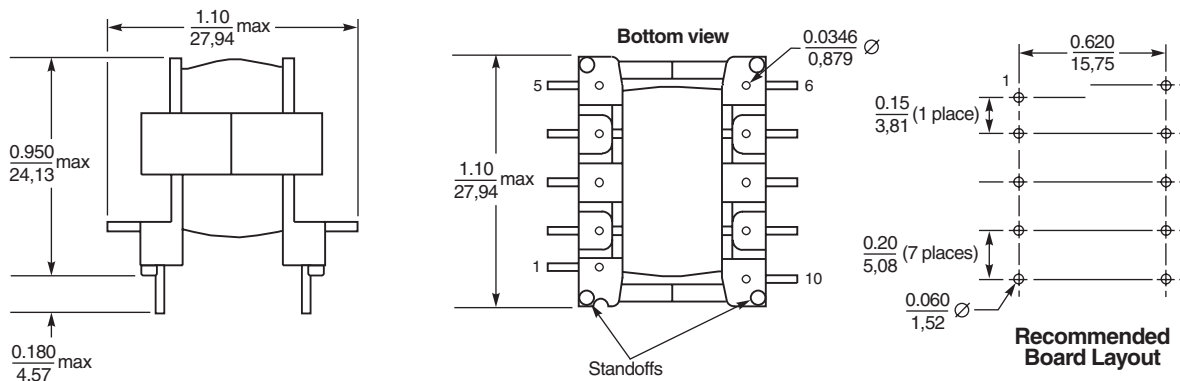

**Terminations** RoHS tin-silver over tin over copper.  
Packaged 30 parts per tray



Specifications subject to change without notice.  
Please check our website for latest information.

Document 183-3 Revised 10/31/08