

Miniature Fuses
Type FST 5 × 20

time-lag T
low breaking capacity L
Glass tube

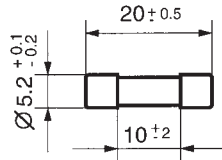

Standards

IEC 60127-2/3, EN 60127-2/3.

Approvals

- SEV
- VDE
- SEMKO
- UL
- CSA
- VDE to / bis 6,3 A
- VDE 8 A + 10 A

Pre-arcing time/current characteristic (at T_a 23 °C)

Rated current I _n	1,5 · I _{rat} *		2,1 · I _{rat}		2,75 · I _{rat}		4 · I _{rat}		10 · I _{rat}	
	min.	max.	min.	max.	min.	max.	min.	max.	min.	max.
20 mA	60 min				40 ms	3 s	10 ms	300 ms		
32 mA – 100 mA	60 min	2 min	200 ms	10 s	40 ms	3 s	10 ms	300 ms		
> 100 mA – 6,3 A	60 min	2 min	600 ms	10 s	150 ms	3 s	20 ms	300 ms		
> 6,3 A – 20 A	30 min	2 min	600 ms	10 s	150 ms	3 s	20 ms	300 ms		

* Non fusing current I_{nf}
** These values are not guaranteed at 20 mA

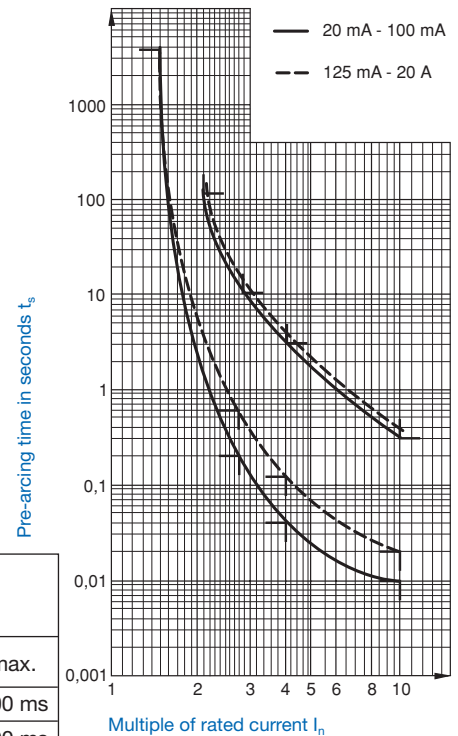

Order No. /	Rated current I _n Rated voltage U _n	Breaking capacity	Voltage drop		Sustained power dissipation		Pre-arcing I ² t at 10 · I _n typ. A ² s	Approvals						
			at max. I _n IEC 60127 mV	typ. I _n mV	at max. 1,5 I _n IEC 60127 W	typ. 1,5 I _n W		SEV	VDE	SEMKO	UL	CSA		
0034.3101	20 mA* / 250 V	L = 35 A / 250 V AC, p.f. / cos φ 1		2700		0,1	1,2 · 10 ⁻³							
0034.3102	32 mA / 250 V		5000	3000	1,6	0,2	1,9 · 10 ⁻³	•	•	•	•	•		
0034.3103	40 mA / 250 V		4000	2100	1,6	0,2	2,7 · 10 ⁻³	•	•	•	•	•		
0034.3104	50 mA / 250 V		3500	950	1,6	0,125	3,63 · 10 ⁻²	•	•	•	•	•		
0034.3105	63 mA / 250 V		3000	1300	1,6	0,2	4,01 · 10 ⁻²	•	•	•	•	•		
0034.3106	80 mA / 250 V		3000	1100	1,6	0,3	5,70 · 10 ⁻²	•	•	•	•	•		
0034.3107	100 mA / 250 V		2500	1000	1,6	0,3	1,07 · 10 ⁻¹	•	•	•	•	•		
0034.3108	125 mA / 250 V		2000	400	1,6	0,2	6,4 · 10 ⁻²	•	•	•	•	•		
0034.3109	160 mA / 250 V		1900	340	1,6	0,2	2,3 · 10 ⁻¹	•	•	•	•	•		
0034.3110	200 mA / 250 V		1500	270	1,6	0,2	2,56 · 10 ⁻¹	•	•	•	•	•		
0034.3111	250 mA / 250 V		1300	210	1,6	0,2	2,38 · 10 ⁻¹	•	•	•	•	•		
0034.3112	315 mA / 250 V		1100	170	1,6	0,2	5,44 · 10 ⁻¹	•	•	•	•	•		
0034.3113	400 mA / 250 V		1000	150	1,6	0,2	7,68 · 10 ⁻¹	•	•	•	•	•		
0034.3114	500 mA / 250 V		900	160	1,6	0,2	3	•	•	•	•	•		
0034.3115	630 mA / 250 V		300	160	1,6	0,3	4,35	•	•	•	•	•		
0034.3116	800 mA / 250 V		250	120	1,6	0,3	3,85	•	•	•	•	•		
0034.3117	1 A / 250 V		150	60	1,6	0,2	3,30	•	•	•	•	•		
0034.3118	1,25 A / 250 V		150	60	1,6	0,3	5,50	•	•	•	•	•		
0034.3165	1,4 A* / 250 V		60	60	0,3	0,3	7,45						•	
0034.3119	1,6 A / 250 V		150	60	1,6	0,3	10,5	•	•	•	•	•		
0034.3120	2 A / 250 V	150	60	1,6	0,3	16	•	•	•	•	•			
0034.3121	2,5 A / 250 V	120	60	1,6	0,4	21,9	•	•	•	•	•			
0034.3122	3,15 A / 250 V	100	60	1,6	0,5	47	•	•	•	•	•			
0034.3123	4 A / 250 V	100	60	1,6	0,8	68,3	•	•	•	•	•			
0034.3124	5 A / 250 V	100	60	1,6	0,9	102	•	•	•	•	•			
0034.3125	6,3 A / 250 V	100	60	1,6	1,0	190	•	•	•	•	•			
0034.3126	8 A / 250 V*	100	60	4	1,3	275	•	•	•	•	•			
0034.3127	10 A / 250 V*	100	60	4	1,3	520	•	•	•	•	•			
0034.3128	12,5 A / 250 V*	60	60	2,5	2,5	750						•	•	
0034.3129	16 A / 250 V*	60	60	3,3	3,3	1638						•	•	
0034.3130	20 A / 250 V*	60	60	4,2	4,2	3057						•	•	

* Not mentioned in the standards



Available as Pigtail miniature fuse-links, see page 100

FST 5 x 20 Miniature Fuses pre-inserted into fuseholder OGN-SMD see page 167, 168

FUSES

Non resettable

SP 5 × 20, SPT 5 × 20, FSF 5 × 20, FST 5 × 20

Pigtails

Miniature Fuses with Pigtails Type SP 5 × 20

quick acting F
high breaking capacity



Order No.		I_n / U_n
0001.1001.PT	0001.1001.TR	500 mA / 250 V
0001.1002.PT	0001.1002.TR	630 mA / 250 V
0001.1003.PT	0001.1003.TR	800 mA / 250 V
0001.1004.PT	0001.1004.TR	1 A / 250 V
0001.1005.PT	0001.1005.TR	1,25 A / 250 V
0001.1006.PT	0001.1006.TR	1,6 A / 250 V
0001.1007.PT	0001.1007.TR	2 A / 250 V
0001.1008.PT	0001.1008.TR	2,5 A / 250 V
0001.1009.PT	0001.1009.TR	3,15 A / 250 V
0001.1010.PT	0001.1010.TR	4 A / 250 V
0001.1011.PT	0001.1011.TR	5 A / 250 V
0001.1012.PT	0001.1012.TR	6,3 A / 250 V
0001.1013.PT	0001.1013.TR	8 A / 250 V
0001.1014.PT	0001.1014.TR	10 A / 250 V

Technical data see page 96

Miniature Fuses with Pigtails Type FSF 5 × 20

quick acting F
low breaking capacity

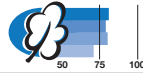

Order No.		I_n / U_n
0034.1513.PT	0034.1513.TR	500 mA / 250 V
0034.1514.PT	0034.1514.TR	630 mA / 250 V
0034.1515.PT	0034.1515.TR	800 mA / 250 V
0034.1516.PT	0034.1516.TR	1 A / 250 V
0034.1517.PT	0034.1517.TR	1,25 A / 250 V
0034.1518.PT	0034.1518.TR	1,6 A / 250 V
0034.1519.PT	0034.1519.TR	2 A / 250 V
0034.1520.PT	0034.1520.TR	2,5 A / 250 V
0034.1521.PT	0034.1521.TR	3,15 A / 250 V
0034.1522.PT	0034.1522.TR	4 A / 250 V
0034.1523.PT	0034.1523.TR	5 A / 250 V
0034.1524.PT	0034.1524.TR	6,3 A / 250 V
0034.1525.PT	0034.1525.TR	8 A / 250 V

Technical data see page 89

Packaging :

00XX.XXXX.PT Boxes of 1000 pieces
00XX.XXXX.TR Taped and reeled

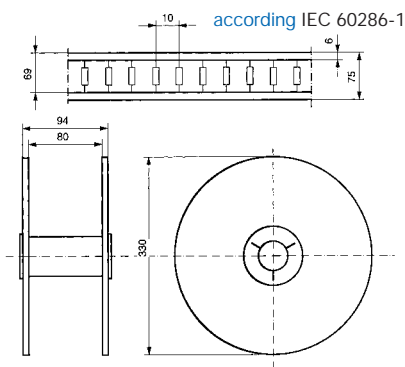

Miniature Fuses with Pigtails Type SPT 5 × 20

time-lag T
high breaking capacity

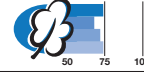

Order No.		I_n / U_n
0001.2504.PT	0001.2504.TR	1 A / 250 V
0001.2505.PT	0001.2505.TR	1,25 A / 250 V
0001.2506.PT	0001.2506.TR	1,6 A / 250 V
0001.2507.PT	0001.2507.TR	2 A / 250 V
0001.2508.PT	0001.2508.TR	2,5 A / 250 V
0001.2509.PT	0001.2509.TR	3,15 A / 250 V
0001.2510.PT	0001.2510.TR	4 A / 250 V
0001.2511.PT	0001.2511.TR	5 A / 250 V
0001.2512.PT	0001.2512.TR	6,3 A / 250 V
0001.2513.PT	0001.2513.TR	8 A / 250 V
0001.2514.PT	0001.2514.TR	10 A / 250 V

Technical data see page 97

Miniature Fuses with Pigtails Type FST 5 × 20

time-lag T
low breaking capacity

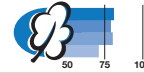

Order No.		I_n / U_n
0034.3104.PT	0034.3104.TR	50 mA / 250 V
0034.3105.PT	0034.3105.TR	63 mA / 250 V
0034.3106.PT	0034.3106.TR	80 mA / 250 V
0034.3107.PT	0034.3107.TR	100 mA / 250 V
0034.3108.PT	0034.3108.TR	125 mA / 250 V
0034.3109.PT	0034.3109.TR	160 mA / 250 V
0034.3110.PT	0034.3110.TR	200 mA / 250 V
0034.3111.PT	0034.3111.TR	250 mA / 250 V
0034.3112.PT	0034.3112.TR	315 mA / 250 V
0034.3113.PT	0034.3113.TR	400 mA / 250 V
0034.3114.PT	0034.3114.TR	500 mA / 250 V
0034.3115.PT	0034.3115.TR	630 mA / 250 V
0034.3116.PT	0034.3116.TR	800 mA / 250 V
0034.3117.PT	0034.3117.TR	1 A / 250 V
0034.3118.PT	0034.3118.TR	1,25 A / 250 V
0034.3165.PT	0034.3165.TR	1,4 A / 250 V
0034.3119.PT	0034.3119.TR	1,6 A / 250 V
0034.3120.PT	0034.3120.TR	2 A / 250 V
0034.3121.PT	0034.3121.TR	2,5 A / 250 V
0034.3122.PT	0034.3122.TR	3,15 A / 250 V
0034.3123.PT	0034.3123.TR	4 A / 250 V
0034.3124.PT	0034.3124.TR	5 A / 250 V
0034.3125.PT	0034.3125.TR	6,3 A / 250 V
0034.3126.PT	0034.3126.TR	8 A / 250 V

Technical data see page 90

Dimensions

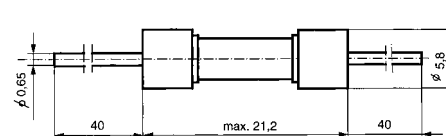

Pigtail only approved up to 8 A