

## 2SB1031 (K)

SILICON PNP EPITAXIAL

LOW FREQUENCY POWER AMPLIFIER  
COMPLEMENTARY PAIR WITH 2SD1435 (K)

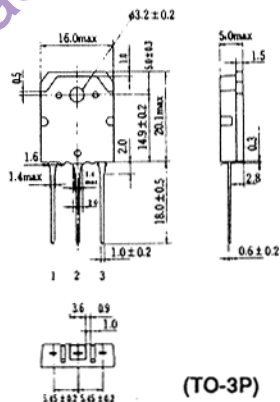

1. Base
  2. Collector (Flange)
  3. Emitter
- (Dimensions in mm)

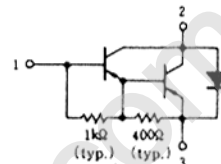

### ■ ABSOLUTE MAXIMUM RATINGS (Ta=25°C)

Item	Symbol	2SB1031 (K)	Unit
Collector to base voltage	V <sub>CB0</sub>	-100	V
Collector to emitter voltage	V <sub>CEO</sub>	-100	V
Emitter to base voltage	V <sub>EBO</sub>	-7	V
Collector current	I <sub>C</sub>	-15	A
Collector peak current	i <sub>C(peak)</sub>	-20	A
Base current	I <sub>B</sub>	-3	A
Collector power dissipation	P <sub>C*</sub>	100	W
Junction temperature	T <sub>j</sub>	150	°C
Storage temperature	T <sub>stg</sub>	-55 to +150	°C

\* Value at T<sub>C</sub> = 25°C

### MAXIMUM COLLECTOR DISSIPATION CURVE

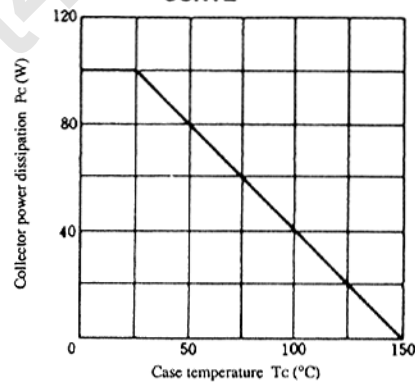

### ■ ELECTRICAL CHARACTERISTICS (Ta=25°C)

Item	Symbol	Test Condition	min.	typ.	max.	Unit
Collector to emitter breakdown voltage	V <sub>(BR)CEO</sub>	I <sub>C</sub> = -1mA, R <sub>BE</sub> = ∞	-100	—	—	V
Emitter to base breakdown voltage	V <sub>(BR)EBO</sub>	I <sub>E</sub> = -50mA, I <sub>C</sub> = 0	-7	—	—	V
Collector to emitter sustain voltage	V <sub>CEO(sus)</sub>	I <sub>C</sub> = -200mA, R <sub>BE</sub> = ∞*	-100	—	—	V
Collector cutoff current	I <sub>CB0</sub>	V <sub>CB</sub> = -100V, I <sub>E</sub> = 0	—	—	-100	μA
	I <sub>CEO</sub>	V <sub>CE</sub> = -80V, R <sub>BE</sub> = ∞	—	—	-1.0	μA
DC current transfer ratio	h <sub>FE</sub>	V <sub>CE</sub> = -3V, I <sub>C</sub> = -8A*	1000	—	20000	
Collector to emitter saturation voltage	V <sub>CE(sat)1</sub>	I <sub>C</sub> = -8A, I <sub>B</sub> = -16mA*	—	—	-2.0	V
Base to emitter saturation voltage	V <sub>BE(sat)1</sub>		—	—	-2.5	V
Collector to emitter saturation voltage	V <sub>CE(sat)2</sub>	I <sub>C</sub> = -15A, I <sub>B</sub> = -150mA*	—	—	-3.0	V
Base to emitter saturation voltage	V <sub>BE(sat)2</sub>		—	—	-3.5	V
Turn on time	t <sub>on</sub>	I <sub>C</sub> = -8A,	—	2	—	μs
Turn off time	t <sub>off</sub>	I <sub>B1</sub> = -I <sub>B2</sub> = -16mA	—	8	—	μs

\* Pulse Test

AREA OF SAFE OPERATION

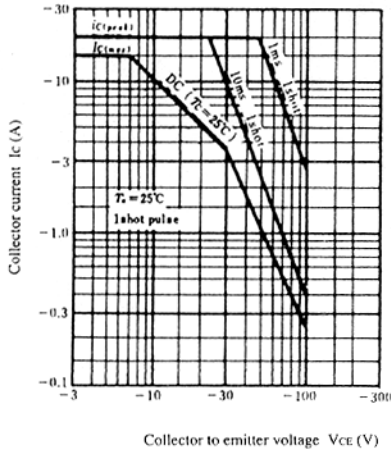

TYPICAL OUTPUT CHARACTERISTICS

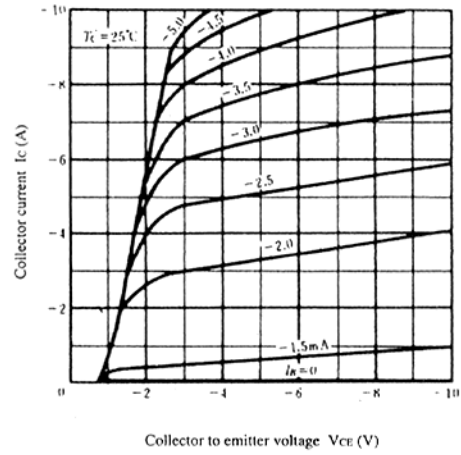

DC CURRENT TRANSFER RATIO VS. COLLECTOR CURRENT

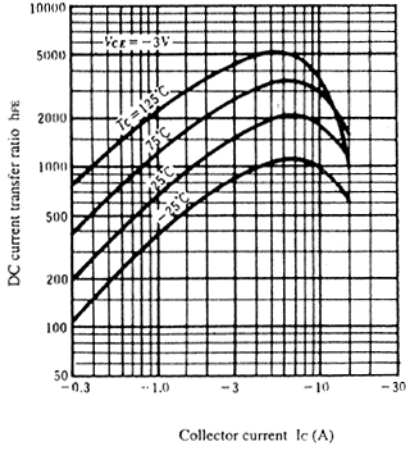

SATURATION VOLTAGE VS. COLLECTOR CURRENT

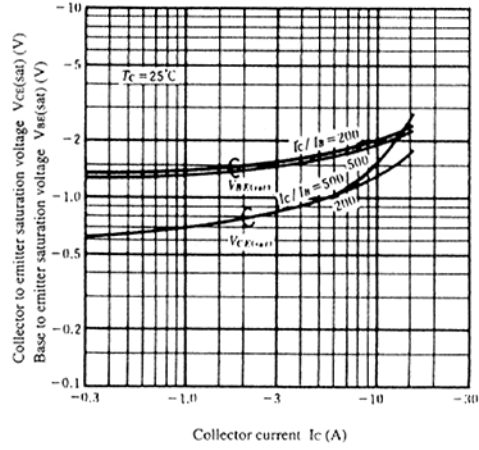

SWITCHING TIME TEST CIRCUIT

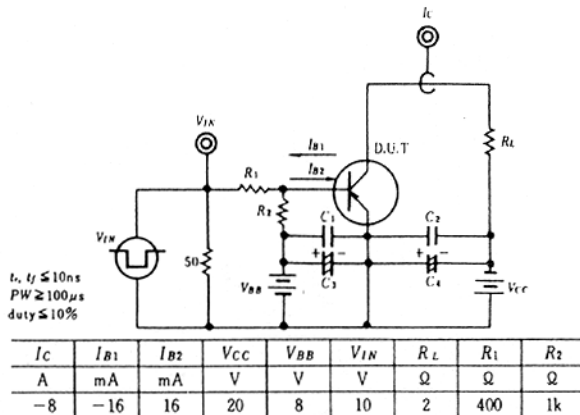

RESPONSE WAVEFORM

