

High Reliability Wideband Transformers

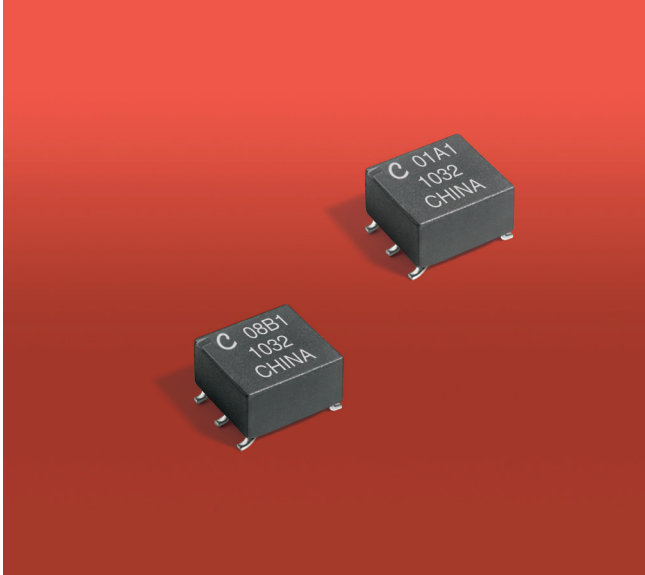

- Small wideband transformer: 7.2 × 6.43 × 4.45 mm high
- 300 V interwinding isolation, 1/4 Watt RF input power
- 250 mA max current rating.

Core material Ferrite

Terminations tin-silver-copper over tin over nickel over phos bronze.

Ambient temperature –55°C to +125°C

Storage temperature Component: –55°C to +125°C.

Tape and reel packaging: –55°C to +80°C

Resistance to soldering heat Max three 40 second reflows at +260°C, parts cooled to room temperature between cycles

Moisture Sensitivity Level (MSL) 1 (unlimited floor life at <30°C / 85% relative humidity)

Enhanced crush-resistant packaging 750/7" reel

Plastic tape: 12 mm wide, 0.3 mm thick, 8 mm pocket spacing, 2.9 mm pocket depth

Part number	Schematic	Impedance ratio ¹ pri:sec	Bandwidth (MHz)	Insertion loss max (dB)	Pins 1-3 (primary)		Pins 6-4 (secondary)	
					L min ² (µH)	DCR max ³ (mOhm)	L min ² (µH)	DCR max ³ (mOhm)
ML520RFA01A1LZ	A	1 : 1	0.045 – 365	0.25	60	130	60	130
ML520RFA01B1LZ	B	1 : 1	0.045 – 365	0.25	60	130	60	130
ML520RFA02B1LZ	B	1 : 2	0.045 – 495	0.25	60	130	140	180
ML520RFA03B1LZ	B	1 : 3	0.075 – 425	0.35	40	120	140	180
ML520RFA04B1LZ	B	1 : 4	0.120 – 440	0.60	25	90	100	160
ML520RFA08B1LZ	B	1 : 8	0.105 – 300	0.60	25	90	200	180
ML520RFA09B1LZ	B	1 : 9	0.075 – 200	0.30	40	120	500	250
ML520RFA16B1LZ	B	1 : 16	0.105 – 135	0.60	25	90	500	250

1. Impedance ratio is for the full primary winding to the full secondary winding.

2. Inductance measured at 100 kHz, 0.1 V, 0 Adc on an Voltech AT3600 or equivalent.

3. DCR measured on a Voltech AT3600 or equivalent.

4. Electrical specifications at 25°C.

Refer to Doc 362 "Soldering Surface Mount Components" before soldering.

Schematics

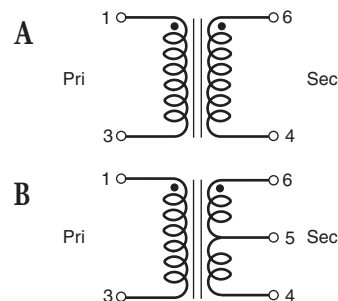

ML520RFA Series

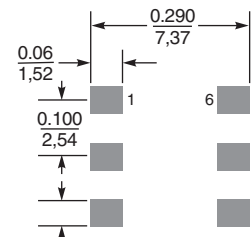
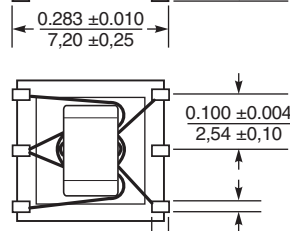
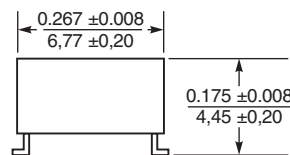
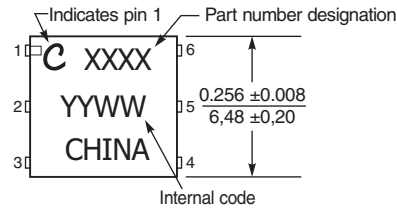
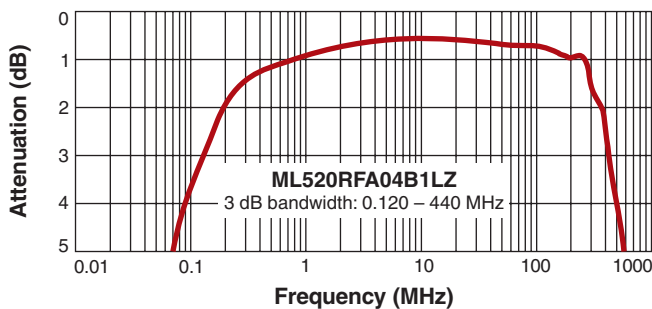
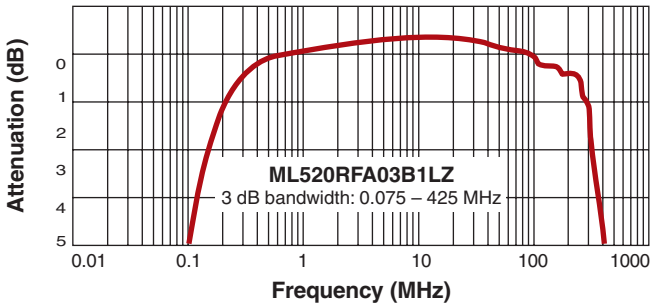
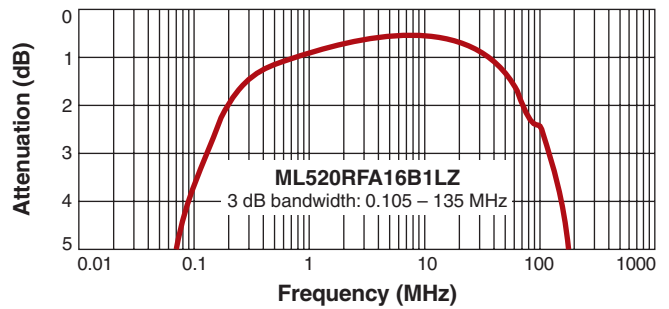
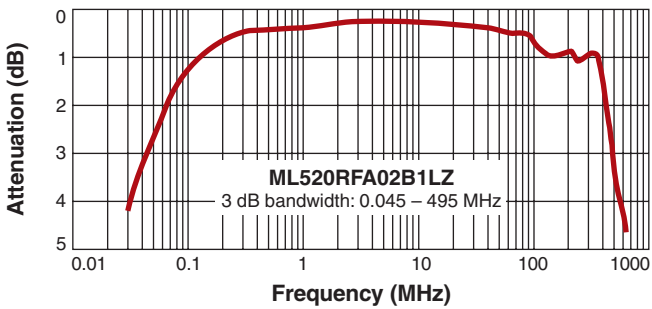
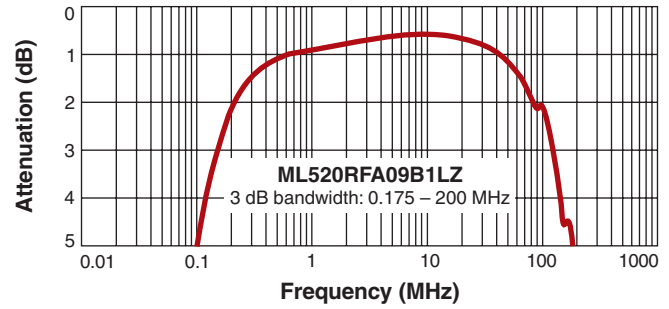
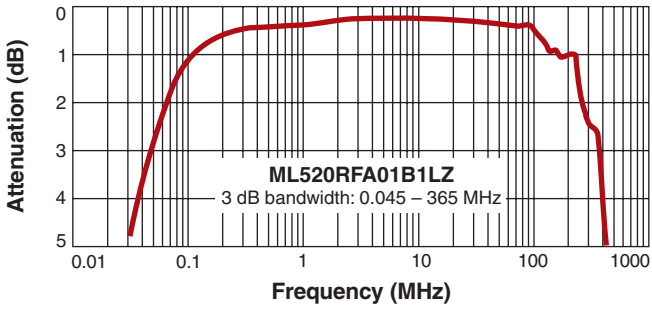
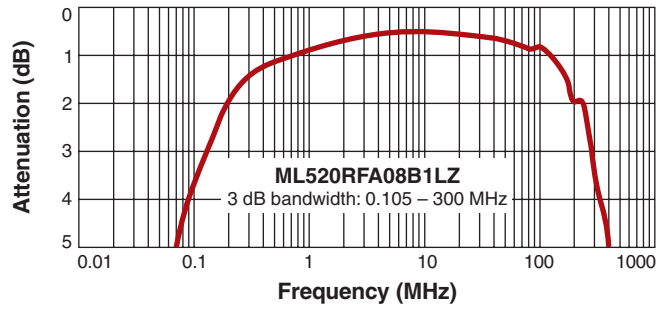
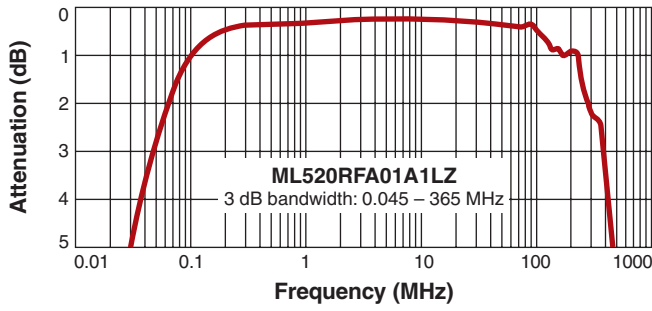

Dimensions are in inches/mm