

256Mb N-die DDR SDRAM

66TSOP-(II) with Lead-Free & Halogen-Free
(RoHS compliant)

datasheet

SAMSUNG ELECTRONICS RESERVES THE RIGHT TO CHANGE PRODUCTS, INFORMATION AND SPECIFICATIONS WITHOUT NOTICE.

Products and specifications discussed herein are for reference purposes only. All information discussed herein is provided on an "AS IS" basis, without warranties of any kind.

This document and all information discussed herein remain the sole and exclusive property of Samsung Electronics. No license of any patent, copyright, mask work, trademark or any other intellectual property right is granted by one party to the other party under this document, by implication, estoppel or otherwise.

Samsung products are not intended for use in life support, critical care, medical, safety equipment, or similar applications where product failure could result in loss of life or personal or physical harm, or any military or defense application, or any governmental procurement to which special terms or provisions may apply.

For updates or additional information about Samsung products, contact your nearest Samsung office.

All brand names, trademarks and registered trademarks belong to their respective owners.

© 2010 Samsung Electronics Co., Ltd. All rights reserved.

Revision History

<u>Revision No.</u>	<u>History</u>	<u>Draft Date</u>	<u>Remark</u>	<u>Editor</u>
1.0	- First Release	Apr. 2010	-	S.H.Kim
1.01	- Corrected Typo.	May. 2010	-	S.H.Kim

[Table Of Contents](#)

256Mb N-die DDR SDRAM

1. Key Features.....	4
2. Ordering Information	4
3. Operating Frequencies	4
4. Pin / Ball Description	5
5. Package Physical Dimension.....	6
6. Block Diagram (16Mb x4 / 8Mbx8 / 4Mx16 I/O x4 Banks)	7
7. Input/Output Function Description	8
8. Command Truth Table	9
9. General Description	10
10. Absolute Maximum Rating	10
11. DC Operating Conditions	10
12. DDR SDRAM Spec Items & Test Conditions	11
13. Input/Output Capacitance	11
14. Detailed test condition for DDR SDRAM IDD1 & IDD7A	12
15. DDR SDRAM IDD Spec Table	13
16. AC Operating Conditions	14
17. AC Overshoot/Undershoot specification for Address and Control Pins	14
18. Overshoot/Undershoot specification for Data, Strobe and Mask Pins	15
19. AC Timing Parameters & Specifications	16
20. System Characteristics for DDR SDRAM	17
21. Component Notes	18
22. System Notes.....	20
23. IBIS : I/V Characteristics for Input and Output Buffers.....	21

1. Key Features

- $V_{DD} : 2.5V \pm 0.2V, V_{DDQ} : 2.5V \pm 0.2V$
- Double-data-rate architecture; two data transfers per clock cycle
- Bidirectional data strobe [DQS] (x4,x8) & [L(U)DQS] (x16)
- Four banks operation
- Differential clock inputs(CK and \overline{CK})
- DLL aligns DQ and DQS transition with CK transition
- MRS cycle with address key programs
 - Read latency : DDR266(2, 2.5 Clock), DDR333(2.5 Clock), DDR400(3 Clock)
 - Burst length (2, 4, 8)
 - Burst type (sequential & interleave)
- All inputs except data & DM are sampled at the positive going edge of the system clock(CK)
- Data I/O transactions on both edges of data strobe
- Edge aligned data output, center aligned data input
- LDM,UDM for write masking only (x16)
- DM for write masking only (x4, x8)
- Auto & Self refresh
- 7.8us refresh interval(8K/64ms refresh)
- Maximum burst refresh cycle : 8
- 66pin TSOP II **Lead-Free & Halogen-Free** package
- RoHS compliant

2. Ordering Information

Part No.	Org.	Max Freq.	Interface	Package	NOTE
K4H560438N-LC/LB3	64M x 4	B3(DDR333@CL=2.5)	SSTL2	66pin TSOP II Lead-Free & Halogen-Free	1, 2
K4H560438N-LC/LB0		B0(DDR266@CL=2.5)			2
K4H560838N-LC/LCC	32M x 8	CC(DDR400@CL=3)	SSTL2	66pin TSOP II Lead-Free & Halogen-Free	2
K4H560838N-LC/LB3		B3(DDR333@CL=2.5)			1, 2
K4H561638N-LC/LCC	16M x 16	CC(DDR400@CL=3)	SSTL2	66pin TSOP II Lead-Free & Halogen-Free	2
K4H561638N-LC/LB3		B3(DDR333@CL=2.5)			1, 2

NOTE :

1. "-B3"(DDR333, CL=2.5) can support "-B0"(DDR266, CL=2.5)/ "-A2"(DDR266, CL=2).
2. "L" of Part number(12th digit) stands for RoHS compliant and Halogen-Free product.

3. Operating Frequencies

	CC(DDR400@CL=3)	B3(DDR333@CL=2.5)	A2(DDR266@CL=2.0)	B0(DDR266@CL=2.5)
Speed @CL2	-	133MHz	133MHz	100MHz
Speed @CL2.5	166MHz	166MHz	133MHz	133MHz
Speed @CL3	200MHz	-	-	-
CL-tRCD-tRP	3-3-3	2.5-3-3	2-3-3	2.5-3-3

4. Pin / Ball Description

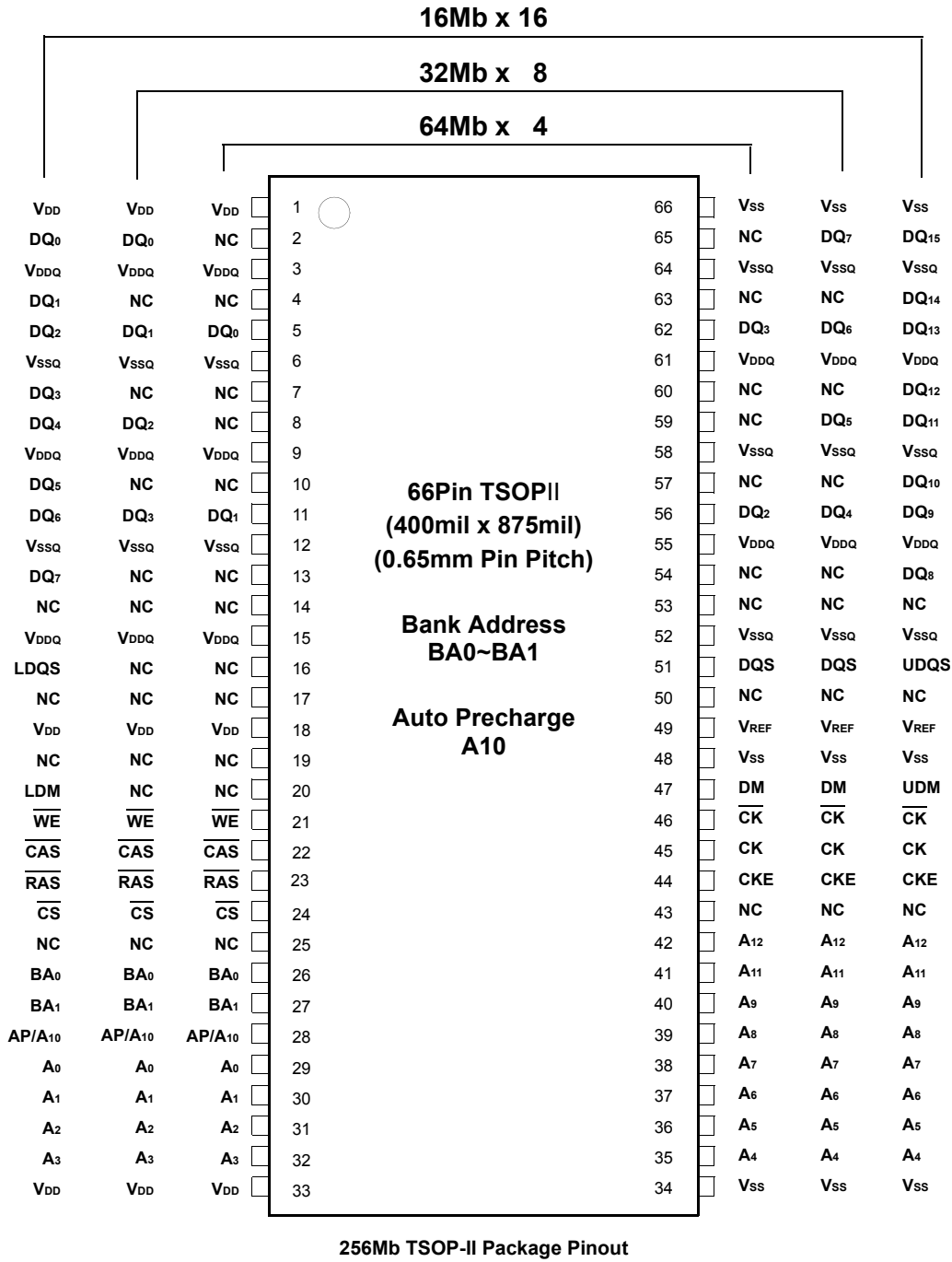

Organization	Row Address	Column Address
64Mx4	A0~A12	A0-A9, A11
32Mx8	A0~A12	A0-A9
16Mx16	A0~A12	A0-A8

DM is internally loaded to match DQ and DQS identically.

Figure 1. Row & Column address configuration

5. Package Physical Dimension

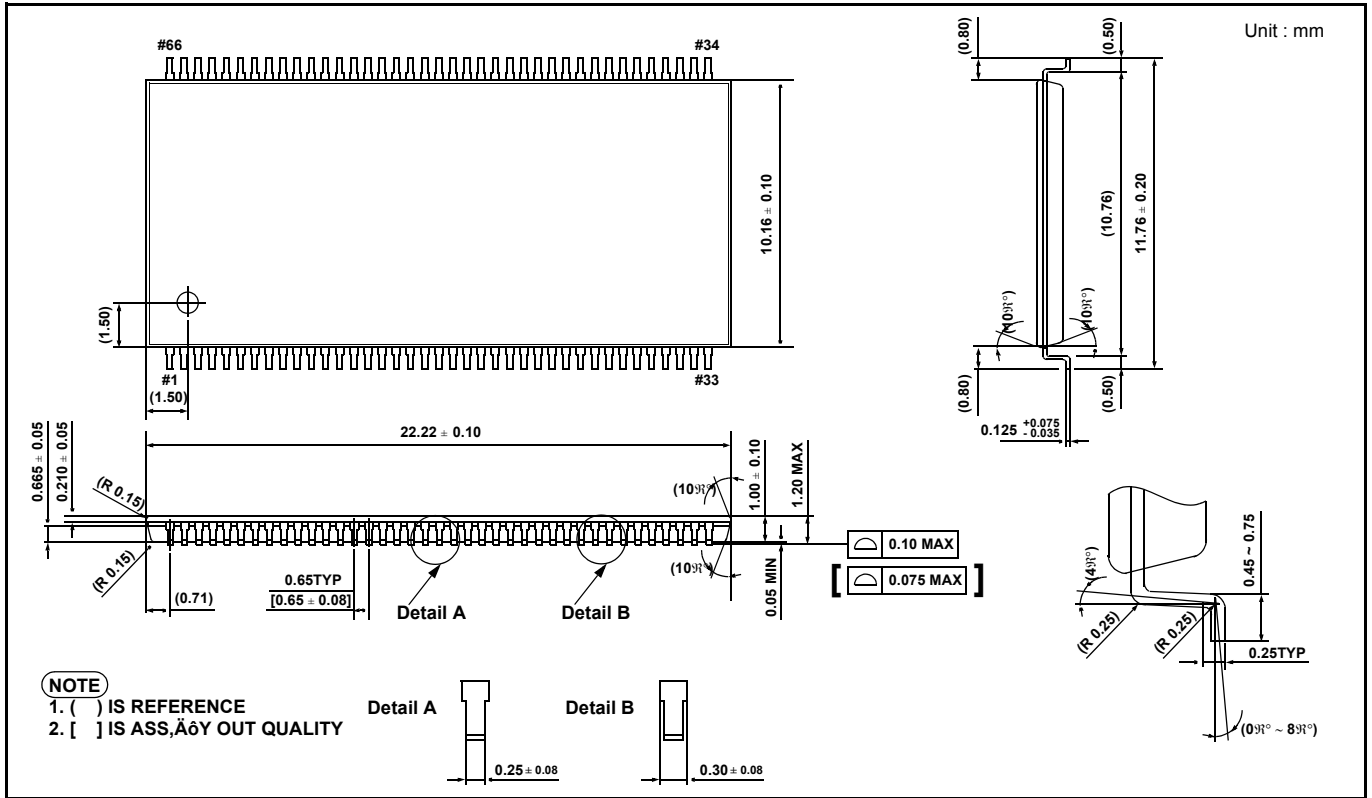
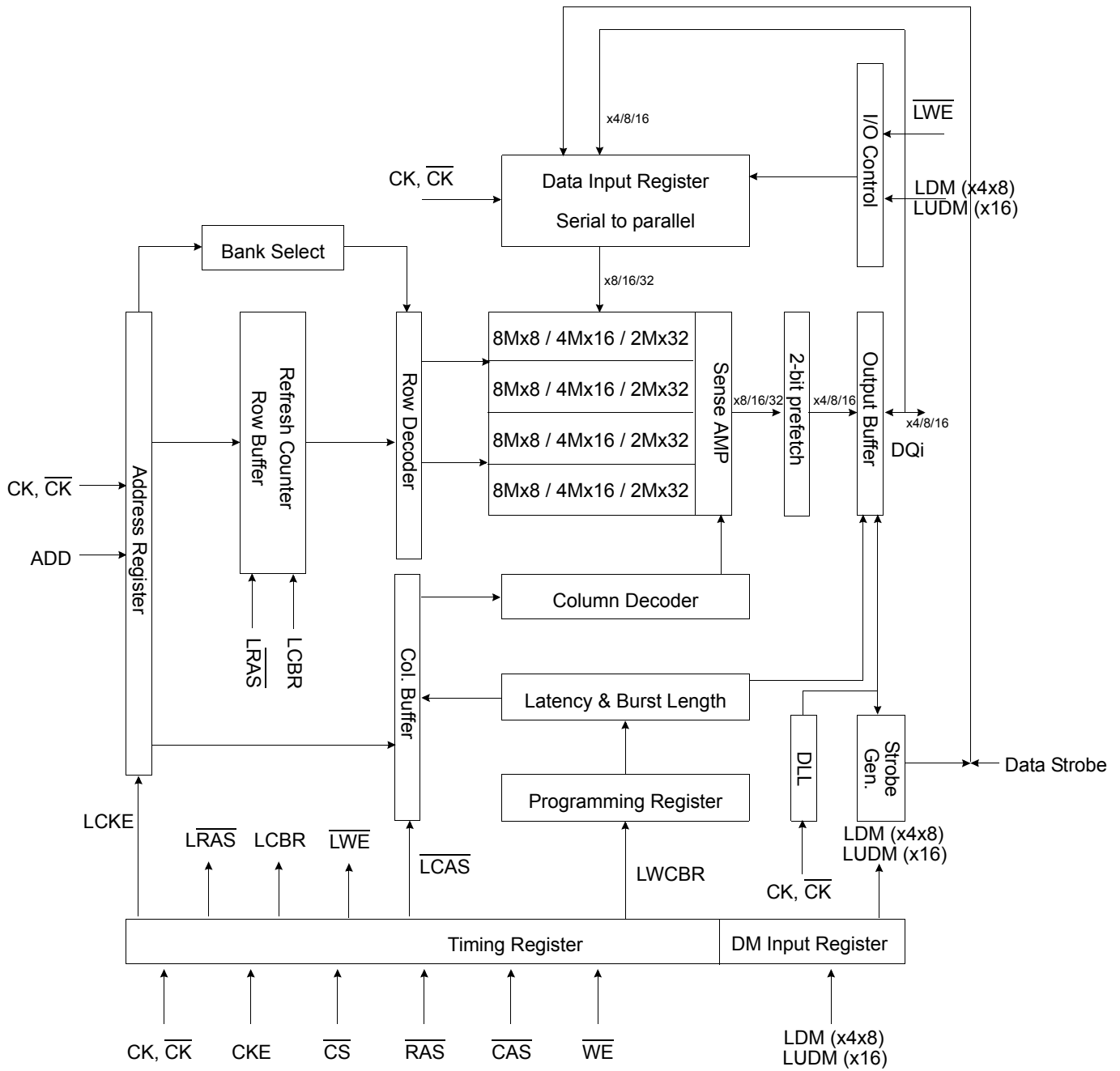

Figure 2. 66Pin TSOP(II) Package Dimension

6. Block Diagram (16Mb x4 / 8Mb x8 / 4Mx16 I/O x4 Banks)



7. Input/Output Function Description

SYMBOL	TYPE	DESCRIPTION
CK, \overline{CK}	Input	Clock : CK and \overline{CK} are differential clock inputs. All address and control input signals are sampled on the positive edge of CK and negative edge of \overline{CK} . Output (read) data is referenced to both edges of CK. Internal clock signals are derived from CK/ \overline{CK} .
CKE	Input	Clock Enable : CKE HIGH activates, and CKE LOW deactivates internal clock signals, and device input buffers and output drivers. Taking CKE Low provides PRECHARGE POWER-DOWN and SELF REFRESH operation (all banks idle), or ACTIVE POWER-DOWN (row ACTIVE in any bank). CKE is synchronous for POWER-DOWN entry and exit, and for SELF REFRESH entry. CKE is asynchronous for SELF REFRESH exit, and for output disable. CKE must be maintained high throughout READ and WRITE accesses. Input buffers, excluding CK, \overline{CK} and CKE are disabled during POWER-DOWN. Input buffers, excluding CKE are disabled during SELF REFRESH. CKE is an SSTL_2 input, but will detect an LVCMOS Low level after V_{DD} is applied upon 1st power up, After V_{REF} has become stable during the power on and initialization sequence, it must be maintained for proper operation of the CKE receiver. For proper SELF-REFRESH entry and exit, V_{REF} must be maintained to this input.
\overline{CS}	Input	Chip Select : \overline{CS} enables (registered LOW) and disables (registered HIGH) the command decoder. All commands are masked when \overline{CS} is registered HIGH. \overline{CS} provides for external bank selection on systems with multiple banks. \overline{CS} is considered part of the command code.
\overline{RAS} , \overline{CAS} , \overline{WE}	Input	Command Inputs : \overline{RAS} , \overline{CAS} and \overline{WE} (along with \overline{CS}) define the command being entered.
LDM,(UDM)	Input	Input Data Mask : DM is an input mask signal for write data. Input data is masked when DM is sampled HIGH along with that input data during a WRITE access. DM is sampled on both edges of DQS. Although DM pins are input only, the DM loading matches the DQ and DQS loading. For the x16, LDM corresponds to the data on DQ0~D7 ; UDM corresponds to the data on DQ8~DQ15. DM may be driven high, low, or floating during READs.
BA0, BA1	Input	Bank Address Inputs : BA0 and BA1 define to which bank an ACTIVE, READ, WRITE or PRECHARGE command is being applied.
A [0 : 12]	Input	Address Inputs : Provide the row address for ACTIVE commands, and the column address and AUTO PRECHARGE bit for READ/WRITE commands, to select one location out of the memory array in the respective bank. A10 is sampled during a PRECHARGE command to determine whether the PRECHARGE applies to one bank (A10 LOW) or all banks (A10 HIGH). If only one bank is to be precharged, the bank is selected by BA0, BA1. The address inputs also provide the op-code during a MODE REGISTER SET command. BA0 and BA1 define which mode register is loaded during the MODE REGISTER SET command (MRS or EMRS).
DQ	I/O	Data Input/Output : Data bus
LDQS,(U)DQS	I/O	Data Strobe : Output with read data, input with write data. Edge-aligned with read data, centered in write data. Used to capture write data. For the x16, LDQS corresponds to the data on DQ0~D7 ; UDQS corresponds to the data on DQ8~DQ15. LDQS is NC on x4 and x8.
NC	-	No Connect : No internal electrical connection is present.
V_{DDQ}	Supply	DQ Power Supply : +2.5V \pm 0.2V.
V_{SSQ}	Supply	DQ Ground.
V_{DD}	Supply	Power Supply : +2.5V \pm 0.2V.
V_{SS}	Supply	Ground.
V_{REF}	Input	SSTL_2 reference voltage.

8. Command Truth Table

(V=Valid, X=Don't Care, H=Logic High, L=Logic Low)

COMMAND		CKEn-1	CKEn	\overline{CS}	\overline{RAS}	\overline{CAS}	\overline{WE}	BA0,1	A10/AP	A0 ~ A9, A11 ~ A12	NOTE	
Register	Extended MRS	H	X	L	L	L	L	OP CODE			1, 2	
Register	Mode Register Set	H	X	L	L	L	L	OP CODE			1, 2	
Refresh	Auto Refresh		H	H	L	L	L	H	X		3	
	Self Refresh	Entry		L	L	L	L	H	X		3	
		Exit	L	H	L	H	H	H	X		3	
				L	H	X	X	X	X		3	
Bank Active & Row Addr.		H	X	L	L	H	H	V	Row Address			
Read & Column Address	Auto Precharge Disable		H	X	L	H	L	H	V	L	Column Address	4
	Auto Precharge Enable								H	Column Address	4	
Write & Column Address	Auto Precharge Disable		H	X	L	H	L	L	V	L	Column Address	4
	Auto Precharge Enable								H	Column Address	4, 6	
Burst Stop		H	X	L	H	H	L	X			7	
Precharge	Bank Selection		H	X	L	L	H	L	V	L	X	5
	All Banks								X	H		
Active Power Down	Entry	H	L	H	X	X	X	X				
				L	V	V	V					
	Exit	L	H	X	X	X	X					
Precharge Power Down Mode	Entry	H	L	H	X	X	X	X				
				L	H	H	H					
	Exit	L	H	H	X	X	X					
				L	V	V	V					
DM(UDM/LDM for x16 only)		H			X				X		8	
No operation (NOP) : Not defined		H	X	H	X	X	X	X			9	
				L	H	H	H					

NOTE :

- OP Code : Operand Code. A0 ~ A12 & BA0 ~ BA1 : Program keys. (@EMRS/MRS)
- EMRS/MRS can be issued only at all banks precharge state.
A new command can be issued 2 clock cycles after EMRS or MRS.
- Auto refresh functions are same as the CBR refresh of DRAM.
The automatical precharge without row precharge command is meant by "Auto".
Auto/self refresh can be issued only at all banks precharge state.
- BA0 ~ BA1 : Bank select addresses.
If both BA0 and BA1 are "Low" at read, write, row active and precharge, bank A is selected.
If BA0 is "High" and BA1 is "Low" at read, write, row active and precharge, bank B is selected.
If BA0 is "Low" and BA1 is "High" at read, write, row active and precharge, bank C is selected.
If both BA0 and BA1 are "High" at read, write, row active and precharge, bank D is selected.
- If A10/AP is "High" at row precharge, BA0 and BA1 are ignored and all banks are selected.
- During burst write with auto precharge, new read/write command can not be issued.
Another bank read/write command can be issued after the end of burst.
New row active of the associated bank can be issued at tRP after the end of burst.
- Burst stop command is valid at every burst length.
- DM(x4/8) sampled at the rising and falling edges of the DQS and Data-in are masked at the both edges (Write DM latency is 0).
UDM/LDM(x16 only) sampled at the rising and falling edges of the UDQS/LDQS and Data-in are masked at the both edges (Write UDM/LDM latency is 0).
- This combination is not defined for any function, which means "No Operation(NOP)" in DDR SDRAM.

16M x 4Bit x 4 Banks / 8M x 8Bit x 4 Banks / 4M x 16Bit x 4 Banks Double Data Rate SDRAM

9. General Description

The K4H560438N / K4H560838N / K4H561638N is 268,435,456 bits of double data rate synchronous DRAM organized as 4x 16,777,216 / 4x 8,388,608 / 4x 4,194,304 words by 4/8/16bits, fabricated with SAMSUNG's high performance CMOS technology. Synchronous features with Data Strobe allow extremely high performance up to 400Mb/s per pin. I/O transactions are possible on both edges of DQS. Range of operating frequencies, programmable burst length and programmable latencies allow the device to be useful for a variety of high performance memory system applications.

10. Absolute Maximum Rating

Parameter	Symbol	Value	Unit
Voltage on any pin relative to V_{SS}	V_{IN}, V_{OUT}	-0.5 ~ 3.6	V
Voltage on V_{DD} & V_{DDQ} supply relative to V_{SS}	V_{DD}, V_{DDQ}	1.0 ~ 3.6	V
Storage temperature	T_{STG}	-55 ~ +150	°C
Power dissipation	P_D	1	W
Short circuit current	I_{OS}	50	mA

NOTE : Permanent device damage may occur if ABSOLUTE MAXIMUM RATINGS are exceeded.
Functional operation should be restricted to recommend operation condition.
Exposure to higher than recommended voltage for extended periods of time could affect device reliability.

11. DC Operating Conditions

Recommended operating conditions(Voltage referenced to $V_{SS}=0V$, $T_A=0$ to $70^{\circ}C$)

Parameter	Symbol	Min	Max	Unit	NOTE
Supply voltage	V_{DD}	2.3	2.7	V	
I/O Supply voltage	V_{DDQ}	2.3	2.7	V	
I/O Reference voltage	V_{REF}	$0.49 \cdot V_{DDQ}$	$0.51 \cdot V_{DDQ}$	V	1
I/O Termination voltage(system)	V_{TT}	$V_{REF}-0.04$	$V_{REF}+0.04$	V	2
Input logic high voltage	$V_{IH}(DC)$	$V_{REF}+0.15$	$V_{DDQ}+0.3$	V	
Input logic low voltage	$V_{IL}(DC)$	-0.3	$V_{REF}-0.15$	V	
Input Voltage Level, CK and \overline{CK} inputs	$V_{IN}(DC)$	-0.3	$V_{DDQ}+0.3$	V	
Input Differential Voltage, CK and \overline{CK} inputs	$V_{ID}(DC)$	0.36	$V_{DDQ}+0.6$	V	3
V-I Matching: Pullup to Pulldown Current Ratio	$V_I(\text{Ratio})$	0.71	1.4	-	4
Input leakage current	I_I	-2	2	uA	
Output leakage current	I_{OZ}	-5	5	uA	
Output High Current(Normal strength driver) ; $V_{OUT} = V_{TT} + 0.84V$	I_{OH}	-16.8		mA	
Output High Current(Normal strength driver) ; $V_{OUT} = V_{TT} - 0.84V$	I_{OL}	16.8		mA	
Output High Current(Half strength driver) ; $V_{OUT} = V_{TT} + 0.45V$	I_{OH}	-9		mA	
Output High Current(Half strength driver) ; $V_{OUT} = V_{TT} - 0.45V$	I_{OL}	9		mA	

NOTE :

- V_{REF} is expected to be equal to $0.5 \cdot V_{DDQ}$ of the transmitting device, and to track variations in the dc level of same. Peak-to-peak noise on V_{REF} may not exceed +/-2% of the dc value.
- V_{TT} is not applied directly to the device. V_{TT} is a system supply for signal termination resistors, is expected to be set equal to V_{REF} , and must track variations in the DC level of V_{REF} .
- V_{ID} is the magnitude of the difference between the input level on CK and the input level on \overline{CK} .
- The ratio of the Pull-up current to the Pull-down current is specified for the same temperature and voltage, over the entire temperature and voltage range, for device drain to source voltages from 0.25V to 1.0V. For a given output, it represents the maximum difference between Pull-up and Pull-down drivers due to process variation. The full variation in the ratio of the maximum to minimum Pull-up and Pull-down current will not exceed 1.7 for device drain to source voltages from 0.1 to 1.0.

12. DDR SDRAM Spec Items & Test Conditions

Conditions	Symbol
Operating current - One bank Active-Precharge; tRC=tRCmin; tCK=10ns for DDR200, tCK=7.5ns for DDR266, 6ns for DDR333, 5ns for DDR400; DQ,DM and DQS inputs changing once per clock cycle; address and control inputs changing once every two clock cycles.	IDD0
Operating current - One bank operation ; One bank open, BL=4, Reads - Refer to the following page for detailed test condition	IDD1
Precharge power-down standby current; All banks idle; power - down mode; CKE = <V _{IL} (max); tCK=10ns for DDR200,tCK=7.5ns for DDR266, 6ns for DDR333, 5ns for DDR400; V _{IN} = V _{REF} for DQ,DQS and DM.	IDD2P
Precharge Floating standby current; $\overline{CS} > = V_{IH}(\text{min})$;All banks idle; CKE > = V _{IH} (min); tCK=10ns for DDR200,tCK=7.5ns for DDR266, 6ns for DDR333, 5ns for DDR400; Address and other control inputs changing once per clock cycle; V _{IN} = V _{REF} for DQ,DQS and DM	IDD2F
Precharge Quiet standby current; $\overline{CS} > = V_{IH}(\text{min})$; All banks idle; CKE > = V _{IH} (min); tCK=10ns for DDR200, tCK=7.5ns for DDR266, 6ns for DDR333, 5ns for DDR400; Address and other control inputs stable at >= V _{IH} (min) or <=V _{IL} (max); V _{IN} = V _{REF} for DQ ,DQS and DM	IDD2Q
Active power - down standby current ; one bank active; power-down mode; CKE=< V _{IL} (max); tCK=10ns for DDR200,tCK=7.5ns for DDR266, 6ns for DDR333, 5ns for DDR400; Vin = Vref for DQ,DQS and DM	IDD3P
Active standby current; $\overline{CS} > = V_{IH}(\text{min})$; CKE>=V _{IH} (min); one bank active; tRC=tRASmax; tCK=10ns for DDR200,tCK=7.5ns for DDR266, 6ns for DDR333, 5ns for DDR400; DQ, DQS and DM inputs changing twice per clock cycle; address and other control inputs changing once per clock cycle	IDD3N
Operating current - burst read; Burst length = 2; reads; continguous burst; One bank active; address and control inputs changing once per clock cycle; CL=2 at tCK=10ns for DDR200, CL=2 at 7.5ns for DDR266, CL=2.5 at tCK=7.5ns for DDR266, tCK=6ns for DDR333, CL=3 at tCK=5ns for DDR400; 50% of data changing on every transfer; Iout = 0 m A	IDD4R
Operating current - burst write; Burst length = 2; writes; continuous burst; One bank active address and control inputs changing once per clock cycle; CL=2 at tCK=10ns for DDR200, CL=2 at tCK=7.5ns for DDR266, CL=2.5 at tCK=7.5ns for DDR266, 6ns for DDR333, 5ns for DDR400; DQ, DM and DQS inputs changing twice per clock cycle, 50% of input data changing at every burst	IDD4W
Auto refresh current; tRC = tRFC(min) which is 8*tCK for DDR200 at tCK=10ns; 10*tCK for DDR266 at tCK=7.5ns; 12*tCK for DDR333 at tCK=6ns, 14*tCK for DDR400 at tCK=5ns; distributed refresh	IDD5
Self refresh current; CKE =< 0.2V; External clock on; tCK=10ns for DDR200, tCK=7.5ns for DDR266, 6ns for DDR333, 5ns for DDR400.	IDD6
Operating current - Four bank operation ; Four bank interleaving with BL=4 -Refer to the following page for detailed test condition	IDD7A

13. Input/Output Capacitance

(T_A= 25°C, f=100MHz)

Parameter	Symbol	Min	Max	DeltaCap(max)	Unit	NOTE
Input capacitance (A0 ~ A12, BA0 ~ BA1, CKE, \overline{CS} , \overline{RAS} , \overline{CAS} , \overline{WE})	C _{IN1}	2	3	0.5	pF	4
Input capacitance(CK, \overline{CK})	C _{IN2}	2	3	0.25	pF	4
Data & DQS input/output capacitance	C _{OUT}	4	5	0.5	pF	1,2,3,4
Input capacitance(DM for x4/8, UDM/LDM for x16)	C _{IN3}	4	5		pF	1,2,3,4

- NOTE :**
- These values are guaranteed by design and are tested on a sample basis only.
 - Although DM is an input -only pin, the input capacitance of this pin must model the input capacitance of the DQ and DQS pins. This is required to match signal propagation times of DQ, DQS, and DM in the system.
 - Unused pins are tied to ground.
 - This parameter is sampled. V_{DDQ} = +2.5V +0.2V, V_{DD} = +2.5V+0.2V. For all devices, f=100MHz, t_A=25°C, V_{OUT}(DC) = V_{DDQ}/2, V_{OUT}(peak to peak) = 0.2V. DM inputs are grouped with I/O pins - reflecting the fact that they are matched in loading (to facilitate trace matching at the board level).

14. Detailed test condition for DDR SDRAM IDD1 & IDD7A

IDD1 : Operating current: One bank operation

1. Typical Case: $V_{DD} = 2.5V$, $T=25^{\circ}C$
Worst Case : $V_{DD} = 2.7V$, $T=10^{\circ}C$
2. Only one bank is accessed with $t_{RC}(\min)$, Burst Mode, Address and Control inputs on NOP edge are changing once per clock cycle. $I_{out} = 0mA$
3. Timing patterns
 - B0(133Mhz, CL=2.5) : $t_{CK} = 7.5ns$, $CL=2.5$, $BL=4$, $t_{RCD} = 3*t_{CK}$, $t_{RC} = 9*t_{CK}$, $t_{RAS} = 6*t_{CK}$
Read : A0 N N R0 N N P0 N N A0 N - repeat the same timing with random address changing
*50% of data changing at every burst
 - A2 (133Mhz, CL=2) : $t_{CK} = 7.5ns$, $CL=2$, $BL=4$, $t_{RCD} = 3*t_{CK}$, $t_{RC} = 9*t_{CK}$, $t_{RAS} = 6*t_{CK}$
Read : A0 N N R0 N N P0 N N A0 N - repeat the same timing with random address changing
*50% of data changing at every burst
 - B3(166Mhz, CL=2.5) : $t_{CK}=6ns$, $CL=2.5$, $BL=4$, $t_{RCD}=3*t_{CK}$, $t_{RC} = 10*t_{CK}$, $t_{RAS}=7*t_{CK}$
Read : A0 N N R0 N N P0 N N A0 N - repeat the same timing with random address changing
*50% of data changing at every burst
 - CC(200Mhz,CL = 3) : $t_{CK} = 5ns$, $CL = 3$, $BL = 4$, $t_{RCD} = 3*t_{CK}$, $t_{RC} = 11*t_{CK}$, $t_{RAS} = 8*t_{CK}$
Read : A0 N N R0 N N N N P0 N N - repeat the same timing with random address changing
*50% of data changing at every transfer

Legend : A=Activate, R=Read, W=Write, P=Precharge, N=DESELECT

IDD7A : Operating current: Four bank operation

1. Typical Case: $V_{DD} = 2.5V$, $T=25^{\circ}C$
Worst Case : $V_{DD} = 2.7V$, $T= 10^{\circ}C$
2. Four banks are being interleaved with $t_{RC}(\min)$, Burst Mode, Address and Control inputs on NOP edge are not changing. $I_{out} = 0mA$
4. Timing patterns
 - B0(133Mhz, CL=2.5) : $t_{CK} = 7.5ns$, $CL=2.5$, $BL=4$, $t_{RRD} = 2*t_{CK}$, $t_{RCD} = 3*t_{CK}$, Read with autoprecharge
Read : A0 N A1 R0 A2 R1 A3 R2 N R3 N A0 N A1 R0 - repeat the same timing with random address changing
*50% of data changing at every burst
 - A2(133Mhz, CL=2) : $t_{CK} = 7.5ns$, $CL=2$, $BL=4$, $t_{RRD} = 2*t_{CK}$, $t_{RCD} = 3*t_{CK}$, Read with autoprecharge
Read : A0 N A1 R0 A2 R1 A3 R2 N R3 N A0 N A1 R0 - repeat the same timing with random address changing
*50% of data changing at every burst
 - B3(166Mhz,CL=2.5) : $t_{CK}=6ns$, $CL=2.5$, $BL=4$, $t_{RRD}=2*t_{CK}$, $t_{RCD}=3*t_{CK}$, Read with autoprecharge
Read : A0 N A1 R0 A2 R1 A3 R2 N R3 N A0 N A1 R0 - repeat the same timing with random address changing
*50% of data changing at every burst
 - CC(200Mhz,CL = 3) : $t_{CK} = 5ns$, $CL = 3$, $BL = 4$, $t_{RRD}=2*t_{CK}$, $t_{RCD}=3*t_{CK}$, Read with autoprecharge
Read : A0 N A1 R0 A2 R1 A3 R2 N R3 N A0 N A1 R0 - repeat the same timing with random address changing
*50% of data changing at every transfer

Legend : A=Activate, R=Read, W=Write, P=Precharge, N=DESELECT

15. DDR SDRAM IDD Spec Table

Symbol	64Mx4 (K4H560438N)		Unit	NOTE
	B3(DDR333@CL=2.5)	B0(DDR266@CL=2.5)		
IDD0	45	40	mA	
IDD1	50	45	mA	
IDD2P	3	3	mA	
IDD2F	20	20	mA	
IDD2Q	17	17	mA	
IDD3P	10	10	mA	
IDD3N	25	20	mA	
IDD4R	65	60	mA	
IDD4W	60	55	mA	
IDD5	75	70	mA	
IDD6	Normal	3	mA	
	Low power	1.5	mA	
IDD7A	105	85	mA	

Symbol	32Mx8 (K4H560838N)		Unit	NOTE
	CC(DDR400@CL=3)	B3(DDR333@CL=2.5)		
IDD0	45	45	mA	
IDD1	55	50	mA	
IDD2P	3	3	mA	
IDD2F	20	20	mA	
IDD2Q	17	17	mA	
IDD3P	10	10	mA	
IDD3N	25	25	mA	
IDD4R	80	75	mA	
IDD4W	70	65	mA	
IDD5	80	75	mA	
IDD6	Normal	3	mA	
	Low power	1.5	mA	
IDD7A	125	110	mA	

Symbol	16Mx16 (K4H561638N)		Unit	NOTE
	CC(DDR400@CL=3)	B3(DDR333@CL=2.5)		
IDD0	50	45	mA	
IDD1	60	55	mA	
IDD2P	3	3	mA	
IDD2F	20	20	mA	
IDD2Q	17	17	mA	
IDD3P	15	10	mA	
IDD3N	30	25	mA	
IDD4R	100	90	mA	
IDD4W	75	65	mA	
IDD5	80	80	mA	
IDD6	Normal	3	mA	
	Low power	1.5	mA	
IDD7A	140	120	mA	

16. AC Operating Conditions

Parameter/Condition	Symbol	Min	Max	Unit	NOTE
Input High (Logic 1) Voltage, DQ, DQS and DM signals	$V_{IH}(AC)$	$V_{REF} + 0.31$		V	
Input Low (Logic 0) Voltage, DQ, DQS and DM signals.	$V_{IL}(AC)$		$V_{REF} - 0.31$	V	
Input Differential Voltage, CK and \overline{CK} inputs	$V_{ID}(AC)$	0.7	$V_{DDQ} + 0.6$	V	1
Input Crossing Point Voltage, CK and \overline{CK} inputs	$V_{IX}(AC)$	$0.5 \cdot V_{DDQ} - 0.2$	$0.5 \cdot V_{DDQ} + 0.2$	V	2

NOTE :

- V_{ID} is the magnitude of the difference between the input level on CK and the input level on \overline{CK} .
- The value of V_{IX} is expected to equal $0.5 \cdot V_{DDQ}$ of the transmitting device and must track variations in the dc level of the same.

17. AC Overshoot/Undershoot specification for Address and Control Pins

Parameter	Specification		
	DDR400	DDR333	DDR200/266
Maximum peak amplitude allowed for overshoot	1.5 V	1.5 V	1.5 V
Maximum peak amplitude allowed for undershoot	1.5 V	1.5 V	1.5 V
The area between the overshoot signal and V_{DD} must be less than or equal to	4.5 V-ns	4.5 V-ns	4.5 V-ns
The area between the undershoot signal and GND must be less than or equal to	4.5 V-ns	4.5 V-ns	4.5 V-ns

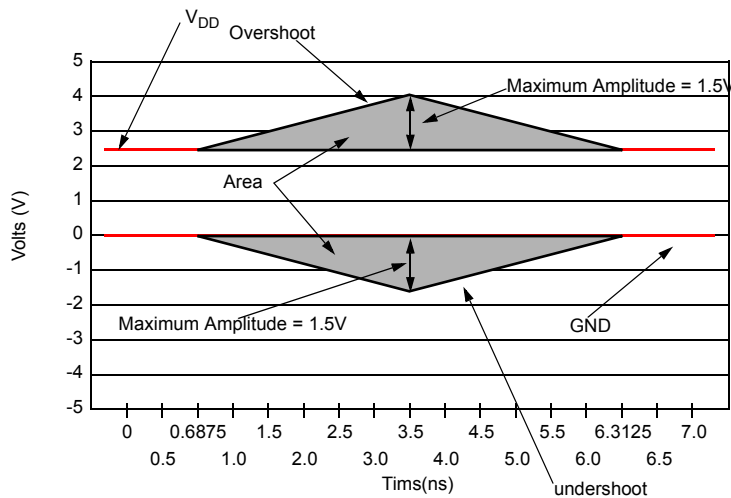

Figure 3. AC overshoot/Undershoot Definition

18. Overshoot/Undershoot specification for Data, Strobe and Mask Pins

Parameter	Specification		
	DDR400	DDR333	DDR200/266
Maximum peak amplitude allowed for overshoot	1.2 V	1.2 V	1.2 V
Maximum peak amplitude allowed for undershoot	1.2 V	1.2 V	1.2 V
The area between the overshoot signal and V_{DD} must be less than or equal to	2.4 V-ns	2.4 V-ns	2.4 V-ns
The area between the undershoot signal and GND must be less than or equal to	2.4 V-ns	2.4 V-ns	2.4 V-ns

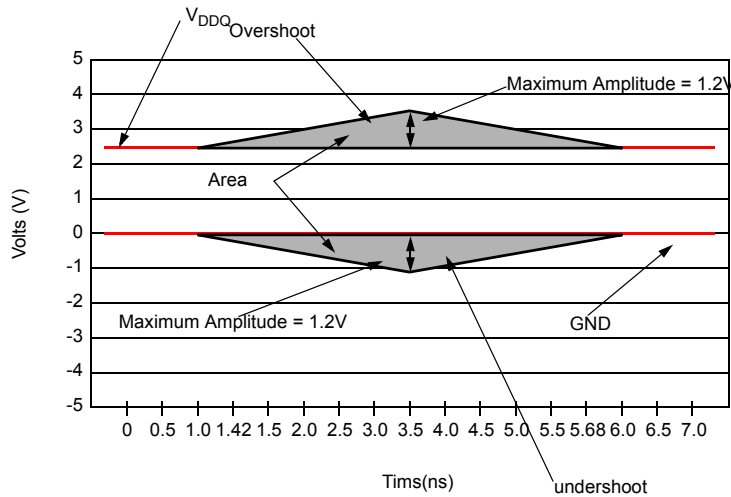

Figure 4. DQ/DM/DQS AC overshoot/Undershoot Definition

19. AC Timing Parameters & Specifications

Parameter	Symbol	CC (DDR400@CL=3.0)		B3 (DDR333@CL=2.5)		A2 (DDR266@CL=2.0)		B0 (DDR266@CL=2.5)		Unit	NOTE
		Min	Max	Min	Max	Min	Max	Min	Max		
Row cycle time	tRC	55		60		65		65		ns	
Refresh row cycle time	tRFC	70		72		75		75		ns	
Row active time	tRAS	40	70K	42	70K	45	120K	45	120K	ns	
RAS to CAS delay	tRCD	15		18		20		20		ns	
Row precharge time	tRP	15		18		20		20		ns	
Row active to Row active delay	tRRD	10		12		15		15		ns	
Write recovery time	tWR	15		15		15		15		ns	
Last data in to Read command	tWTR	2		1		1		1		tCK	
Clock cycle time	CL=2.0	-	-	7.5	12	7.5	12	10	12	ns	
	CL=2.5	6	12	6	12	7.5	12	7.5	12	ns	
	CL=3.0	5	10	-	-	-	-	-	-		
Clock high level width	tCH	0.45	0.55	0.45	0.55	0.45	0.55	0.45	0.55	tCK	
Clock low level width	tCL	0.45	0.55	0.45	0.55	0.45	0.55	0.45	0.55	tCK	
DQS-out access time from CK/CK	tDQSK	-0.55	+0.55	-0.6	+0.6	-0.75	+0.75	-0.75	+0.75	ns	
Output data access time from CK/CK	tAC	-0.65	+0.65	-0.7	+0.7	-0.75	+0.75	-0.75	+0.75	ns	
Data strobe edge to output data edge	tDQSQ	-	0.4	-	0.45	-	0.5	-	0.5	ns	22
Read Preamble	tRPRE	0.9	1.1	0.9	1.1	0.9	1.1	0.9	1.1	tCK	
Read Postamble	tRPST	0.4	0.6	0.4	0.6	0.4	0.6	0.4	0.6	tCK	
CK to valid DQS-in	tDQSS	0.72	1.28	0.75	1.25	0.75	1.25	0.75	1.25	tCK	
DQS-in setup time	tWPRES	0		0		0		0		ns	13
DQS-in hold time	tWPRE	0.25		0.25		0.25		0.25		tCK	
DQS falling edge to CK rising-setup time	tDSS	0.2		0.2		0.2		0.2		tCK	
DQS falling edge from CK rising-hold time	tDSH	0.2		0.2		0.2		0.2		tCK	
DQS-in high level width	tDQSH	0.35		0.35		0.35		0.35		tCK	
DQS-in low level width	tDQSL	0.35		0.35		0.35		0.35		tCK	
Address and Control Input setup time(fast)	tIS	0.6		0.75		0.9		0.9		ns	15, 17~19
Address and Control Input hold time(fast)	tIH	0.6		0.75		0.9		0.9		ns	15, 17~19
Address and Control Input setup time(slow)	tIS	0.7		0.8		1.0		1.0		ns	16~19
Address and Control Input hold time(slow)	tIH	0.7		0.8		1.0		1.0		ns	16~19
Data-out high impedance time from CK/CK	tHZ	-0.65	+0.65	-0.7	+0.7	-0.75	+0.75	-0.75	+0.75	ns	11
Data-out low impedance time from CK/CK	tLZ	-0.65	+0.65	-0.7	+0.7	-0.75	+0.75	-0.75	+0.75	ns	11
Mode register set cycle time	tMRD	10		12		15		15		ns	
DQ & DM setup time to DQS	tDS	0.4		0.45		0.5		0.5		ns	j, k
DQ & DM hold time to DQS	tDH	0.4		0.45		0.5		0.5		ns	j, k
Control & Address input pulse width	tIPW	2.2		2.2		2.2		2.2		ns	18
DQ & DM input pulse width	tDIPW	1.75		1.75		1.75		1.75		ns	18
Exit self refresh to non-Read command	tXSNR	75		75		75		75		ns	
Exit self refresh to read command	tXSRD	200		200		200		200		tCK	
Refresh interval time	tREFI		7.8		7.8		7.8		7.8	us	14
Output DQS valid window	tQH	tHP -tQHS	-	tHP -tQHS	-	tHP -tQHS	-	tHP -tQHS	-	ns	21
Clock half period	tHP	tCLmin or tCHmin	-	tCLmin or tCHmin	-	tCLmin or tCHmin	-	tCLmin or tCHmin	-	ns	20, 21
Data hold skew factor	tQHS		0.5		0.55		0.75		0.75	ns	21
DQS write postamble time	tWPST	0.4	0.6	0.4	0.6	0.4	0.6	0.4	0.6	tCK	12
Active to Read with Auto precharge command	tRAP	15		18		20		20			
Autoprecharge write recovery + Precharge time	tDAL	(tWR/tCK) + (tRP/tCK)		(tWR/tCK) + (tRP/tCK)		(tWR/tCK) + (tRP/tCK)		(tWR/tCK) + (tRP/tCK)		tCK	23
Power Down Exit Time	tPDEX	1		1		1		1		tCK	

20. System Characteristics for DDR SDRAM

The following specification parameters are required in systems using DDR400 and DDR333 devices to ensure proper system performance. these characteristics are for system simulation purposes and are guaranteed by design.

[Table 1] Input Slew Rate for DQ, DQS, and DM

AC CHARACTERISTICS PARAMETER	SYMBOL	DDR400		DDR333		DDR266		Units	NOTE
		MIN	MAX	MIN	MAX	MIN	MAX		
DQ/DM/DQS input slew rate measured between $V_{IH}(DC)$, $V_{IL}(DC)$ and $V_{IL}(DC)$, $V_{IH}(DC)$	DCSLEW	0.5	4.0	0.5	4.0	0.5	4.0	V/ns	a, l

[Table 2] Input Setup & Hold Time Derating for Slew Rate

Input Slew Rate	ΔtIS	ΔtIH	Units	NOTE
0.5 V/ns	0	0	ps	i
0.4 V/ns	+50	0	ps	i
0.3 V/ns	+100	0	ps	i

[Table 3] Input/Output Setup & Hold Time Derating for Slew Rate

Input Slew Rate	ΔtDS	ΔtDH	Units	NOTE
0.5 V/ns	0	0	ps	k
0.4 V/ns	+75	+75	ps	k
0.3 V/ns	+150	+150	ps	k

[Table 4] Input/Output Setup & Hold Derating for Rise/Fall Delta Slew Rate

Delta Slew Rate	ΔtDS	ΔtDH	Units	NOTE
+/- 0.0 V/ns	0	0	ps	j
+/- 0.25 V/ns	+50	+50	ps	j
+/- 0.5 V/ns	+100	+100	ps	j

[Table 5] Output Slew Rate Characteristic (X4, X8 Devices only)

Slew Rate Characteristic	Typical Range (V/ns)	Minimum (V/ns)	Maximum (V/ns)	NOTE
Pull-up Slew Rate	1.2 ~ 2.5	1.0	4.5	a,c,d,f,g,h
Pull-down slew	1.2 ~ 2.5	1.0	4.5	b,c,d,f,g,h

[Table 6] Output Slew Rate Characteristic (X16 Devices only)

Slew Rate Characteristic	Typical Range (V/ns)	Minimum (V/ns)	Maximum (V/ns)	NOTE
Pull-up Slew Rate	1.2 ~ 2.5	0.7	5.0	a,c,d,f,g,h
Pull-down slew	1.2 ~ 2.5	0.7	5.0	b,c,d,f,g,h

[Table 7] Output Slew Rate Matching Ratio Characteristics

AC CHARACTERISTICS PARAMETER	DDR400		DDR333		DDR266		NOTE
	MIN	MAX	MIN	MAX	MIN	MAX	
Output Slew Rate Matching Ratio (Pullup to Pulldown)	0.67	1.5	0.67	1.5	0.67	1.5	e, l

21. Component Notes

1. All voltages referenced to V_{SS} .
2. Tests for ac timing, I_{DD} , and electrical, ac and dc characteristics, may be conducted at nominal reference/supply voltage levels, but the related specifications and device operation are guaranteed for the full voltage range specified.
3. Figure 5 represents the timing reference load used in defining the relevant timing parameters of the part. It is not intended to be either a precise representation of the typical system environment nor a depiction of the actual load presented by a production tester. System designers will use IBIS or other simulation tools to correlate the timing reference load to a system environment. Manufacturers will correlate to their production test conditions (generally a coaxial transmission line terminated at the tester electronics).

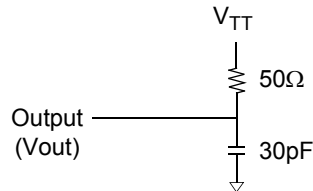

Figure 5. Timing Reference Load

4. AC timing and I_{DD} tests may use a V_{IL} to V_{IH} swing of up to 1.5 V in the test environment, but input timing is still referenced to V_{REF} (or to the crossing point for CK/\overline{CK}), and parameter specifications are guaranteed for the specified ac input levels under normal use conditions. The minimum slew rate for the input signals is 1 V/ns in the range between $V_{IL}(AC)$ and $V_{IH}(AC)$.
5. The ac and dc input level specifications are as defined in the SSTL_2 Standard (i.e., the receiver will effectively switch as a result of the signal crossing the ac input level and will remain in that state as long as the signal does not ring back above (below) the dc input LOW (HIGH) level.
6. Inputs are not recognized as valid until V_{REF} stabilizes. Exception: during the period before V_{REF} stabilizes, $CKE \leq 0.2V_{DDQ}$ is recognized as LOW.
7. Enables on.chip refresh and address counters.
8. I_{DD} specifications are tested after the device is properly initialized.
9. The CK/\overline{CK} input reference level (for timing referenced to CK/\overline{CK}) is the point at which CK and \overline{CK} cross; the input reference level for signals other than CK/\overline{CK} , is V_{REF} .
10. The output timing reference voltage level is V_{TT} .
11. tHZ and tLZ transitions occur in the same access time windows as valid data transitions. These parameters are not referenced to a specific voltage level but specify when the device output is no longer driving (HZ), or begins driving (LZ).
12. The maximum limit for this parameter is not a device limit. The device will operate with a greater value for this parameter, but system performance (bus turnaround) will degrade accordingly.
13. The specific requirement is that DQS be valid (HIGH, LOW, or at some point on a valid transition) on or before this CK edge. A valid transition is defined as monotonic and meeting the input slew rate specifications of the device. when no writes were previously in progress on the bus, DQS will be transitioning from High-Z to logic LOW. If a previous write was in progress, DQS could be HIGH, LOW, or transitioning from HIGH to LOW at this time, depending on tDQSS.
14. A maximum of eight AUTO REFRESH commands can be posted to any given DDR SDRAM device.
15. For command/address input slew rate ≥ 1.0 V/ns
16. For command/address input slew rate ≥ 0.5 V/ns and < 1.0 V/ns
17. For CK & \overline{CK} slew rate ≥ 1.0 V/ns
18. These parameters guarantee device timing, but they are not necessarily tested on each device. They may be guaranteed by device design or tester correlation.
19. Slew Rate is measured between $VOH(AC)$ and $VOL(AC)$.

20. Min (tCL, tCH) refers to the smaller of the actual clock low time and the actual clock high time as provided to the device (i.e. this value can be greater than the minimum specification limits for tCL and tCH).....For example, tCL and tCH are = 50% of the period, less the half period jitter (tJIT(HP)) of the clock source, and less the half period jitter due to crosstalk (tJIT(crosstalk)) into the clock traces.
21. tQH = tHP - tQHS, where:
tHP = minimum half clock period for any given cycle and is defined by clock high or clock low (tCH, tCL). tQHS accounts for 1) The pulse duration distortion of on-chip clock circuits; and 2) The worst case push-out of DQS on one transition followed by the worst case pull-in of DQ on the next transition, both of which are, separately, due to data pin skew and output pattern effects, and p-channel to n-channel variation of the output drivers.
22. tDQSQ
Consists of data pin skew and output pattern effects, and p-channel to n-channel variation of the output drivers for any given cycle.
23. tDAL = (tWR/tCK) + (tRP/tCK)
For each of the terms above, if not already an integer, round to the next highest integer. Example: For DDR400 at CL=3 and tCK=5ns tDAL = (15 ns / 5 ns) + (15 ns / 5ns) = (3) + (3) tDAL = 6 clocks

22. System Notes

a. Pull-up slew rate is characterized under the test conditions as shown in Figure 6.

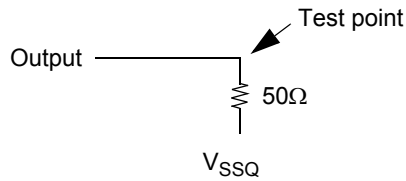

Figure 6. Pull-up slew rate test load

b. Pull-down slew rate is measured under the test conditions shown in Figure 7.

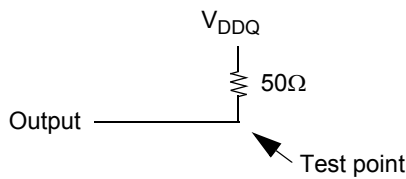

Figure 7. Pull-down slew rate test load

c. Pull-up slew rate is measured between $(V_{DDQ}/2 - 320 \text{ mV} \pm 250 \text{ mV})$
 Pull-down slew rate is measured between $(V_{DDQ}/2 + 320 \text{ mV} \pm 250 \text{ mV})$
 Pull-up and Pull-down slew rate conditions are to be met for any pattern of data, including all outputs switching and only one output switching.
 Example : For typical slew rate, DQ0 is switching
 For minimum slew rate, all DQ bits are switching from either high to low, or low to high.
 The remaining DQ bits remain the same as for previous state.

d. Evaluation conditions
 Typical : 25 °C (T Ambient), $V_{DDQ} = 2.5\text{V}$, typical process
 Minimum : 70 °C (T Ambient), $V_{DDQ} = 2.3\text{V}$, slow - slow process
 Maximum : 0 °C (T Ambient), $V_{DDQ} = 2.7\text{V}$, fast - fast process

e. The ratio of Pull-up slew rate to Pull-down slew rate is specified for the same temperature and voltage, over the entire temperature and voltage range. For a given output, it represents the maximum difference between Pull-up and Pull-down drivers due to process variation.

f. Verified under typical conditions for qualification purposes.

g. TSOP11 package devices only.

h. Only intended for operation up to 400 Mbps per pin.

i. A derating factor will be used to increase t_{IS} and t_{IH} in the case where the input slew rate is below 0.5V/ns as shown in Table 2. The input slew rate is based on the lesser of the slew rates determined by either $V_{IH}(AC)$ to $V_{IL}(AC)$ or $V_{IH}(DC)$ to $V_{IL}(DC)$, similarly for rising transitions.

j. A derating factor will be used to increase t_{DS} and t_{DH} in the case where DQ, DM, and DQS slew rates differ, as shown in Tables 3 & 4. Input slew rate is based on the larger of AC-AC delta rise, fall rate and DC-DC delta rise, Input slew rate is based on the lesser of the slew rates determined by either $V_{IH}(AC)$ to $V_{IL}(AC)$ or $V_{IH}(DC)$ to $V_{IL}(DC)$, similarly for rising transitions.
 The delta rise/fall rate is calculated as:
 $\{1/(\text{Slew Rate1})\} - \{1/(\text{Slew Rate2})\}$

For example : If Slew Rate 1 is 0.5 V/ns and slew Rate 2 is 0.4 V/ns, then the delta rise, fall rate is - 0.5ns/V . Using the table given, this would result in the need for an increase in t_{DS} and t_{DH} of 100 ps.

k. Table 3 is used to increase t_{DS} and t_{DH} in the case where the I/O slew rate is below 0.5 V/ns. The I/O slew rate is based on the lesser of the AC - AC slew rate and the DC- DC slew rate. The input slew rate is based on the lesser of the slew rates determined by either $V_{IH}(AC)$ to $V_{IL}(AC)$ or $V_{IH}(DC)$ to $V_{IL}(DC)$, and similarly for rising transitions.

l. DQS, DM, and DQ input slew rate is specified to prevent double clocking of data and preserve setup and hold times. Signal transitions through the DC region must be monotonic.

23. IBIS : I/V Characteristics for Input and Output Buffers

DDR SDRAM Output Driver V-I Characteristics

DDR SDRAM Output driver characteristics are defined for full and half strength operation as selected by the EMRS bit A1.

Figures 4, 5 and 6 show the driver characteristics graphically, and tables 8, 9 and 10 show the same data in tabular format suitable for input into simulation tools. The driver characteristics evaluation conditions are:

Typical	25xC	$V_{DD}/V_{DDQ} = 2.5V$, typical process
Minimum	70xC	$V_{DD}/V_{DDQ} = 2.3V$, slow-slow process
Maximum	0xC	$V_{DD}/V_{DDQ} = 2.7V$, fast-fast process

Output Driver Characteristic Curves Notes:

1. The full variation in driver current from minimum to maximum process, temperature and voltage will lie within the outer bounding lines the of the V-I curve of Figures 4, 5 and 6.
2. It is recommended that the "typical" IBIS V-I curve lie within the inner bounding lines of the V-I curves of Figures 4, 5 and 6.
3. The full variation in the ratio of the "typical" IBIS Pull-up to "typical" IBIS Pull-down current should be unity +/- 10%, for device drain to source voltages from 0.1 to 1.0. This specification is a design objective only. It is not guaranteed.

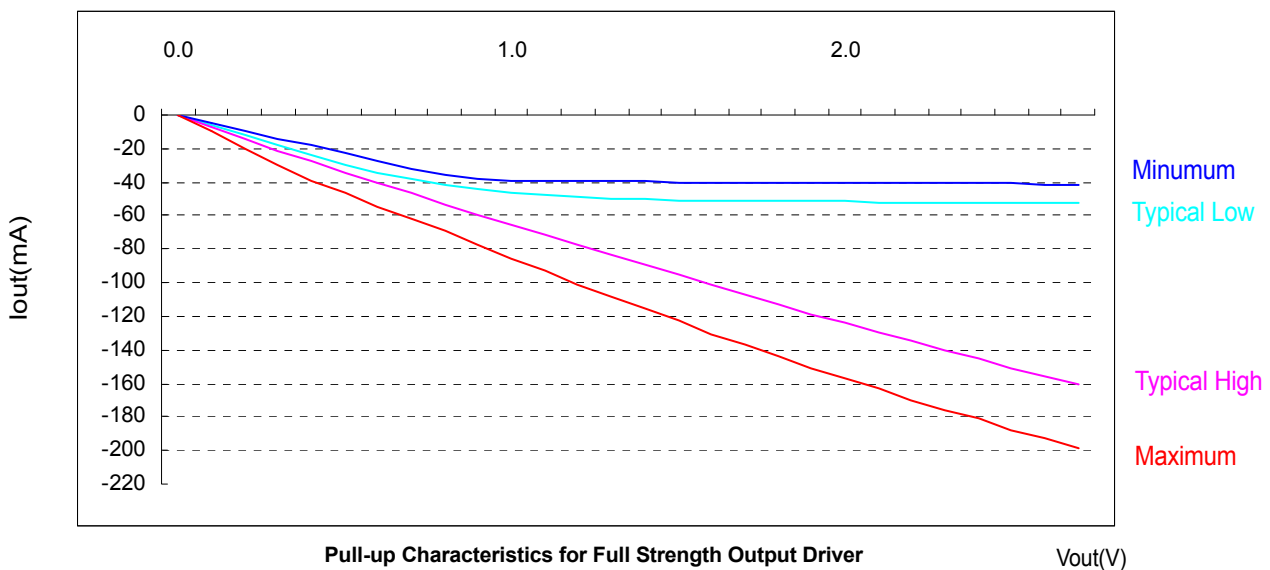
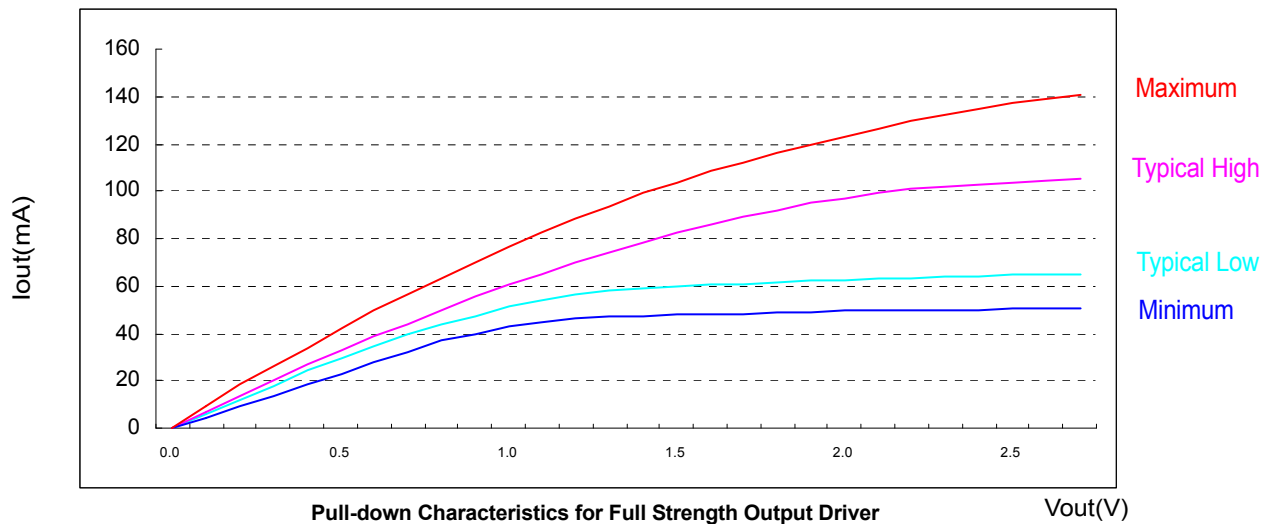

Figure 8. I/V characteristics for input/output buffers : Pull-down(above) and Pull-up(below)

[Table 8] Full Strength Driver Characteristics

Voltage (V)	Pull-down Current (mA)				Pull-up Current (mA)			
	Typical Low	Typical High	Minimum	Maximum	Typical Low	Typical High	Minimum	Maximum
0.1	6.0	6.8	4.6	9.6	-6.1	-7.6	-4.6	-10.0
0.2	12.2	13.5	9.2	18.2	-12.2	-14.5	-9.2	-20.0
0.3	18.1	20.1	13.8	26.0	-18.1	-21.2	-13.8	-29.8
0.4	24.1	26.6	18.4	33.9	-24.0	-27.7	-18.4	-38.8
0.5	29.8	33.0	23.0	41.8	-29.8	-34.1	-23.0	-46.8
0.6	34.6	39.1	27.7	49.4	-34.3	-40.5	-27.7	-54.4
0.7	39.4	44.2	32.2	56.8	-38.1	-46.9	-32.2	-61.8
0.8	43.7	49.8	36.8	63.2	-41.1	-53.1	-36.0	-69.5
0.9	47.5	55.2	39.6	69.9	-41.8	-59.4	-38.2	-77.3
1.0	51.3	60.3	42.6	76.3	-46.0	-65.5	-38.7	-85.2
1.1	54.1	65.2	44.8	82.5	-47.8	-71.6	-39.0	-93.0
1.2	56.2	69.9	46.2	88.3	-49.2	-77.6	-39.2	-100.6
1.3	57.9	74.2	47.1	93.8	-50.0	-83.6	-39.4	-108.1
1.4	59.3	78.4	47.4	99.1	-50.5	-89.7	-39.6	-115.5
1.5	60.1	82.3	47.7	103.8	-50.7	-95.5	-39.9	-123.0
1.6	60.5	85.9	48.0	108.4	-51.0	-101.3	-40.1	-130.4
1.7	61.0	89.1	48.4	112.1	-51.1	-107.1	-40.2	-136.7
1.8	61.5	92.2	48.9	115.9	-51.3	-112.4	-40.3	-144.2
1.9	62.0	95.3	49.1	119.6	-51.5	-118.7	-40.4	-150.5
2.0	62.5	97.2	49.4	123.3	-51.6	-124.0	-40.5	-156.9
2.1	62.9	99.1	49.6	126.5	-51.8	-129.3	-40.6	-163.2
2.2	63.3	100.9	49.8	129.5	-52.0	-134.6	-40.7	-169.6
2.3	63.8	101.9	49.9	132.4	-52.2	-139.9	-40.8	-176.0
2.4	64.1	102.8	50.0	135.0	-52.3	-145.2	-40.9	-181.3
2.5	64.6	103.8	50.2	137.3	-52.5	-150.5	-41.0	-187.6
2.6	64.8	104.6	50.4	139.2	-52.7	-155.3	-41.1	-192.9
2.7	65.0	105.4	50.5	140.8	-52.8	-160.1	-41.2	-198.2

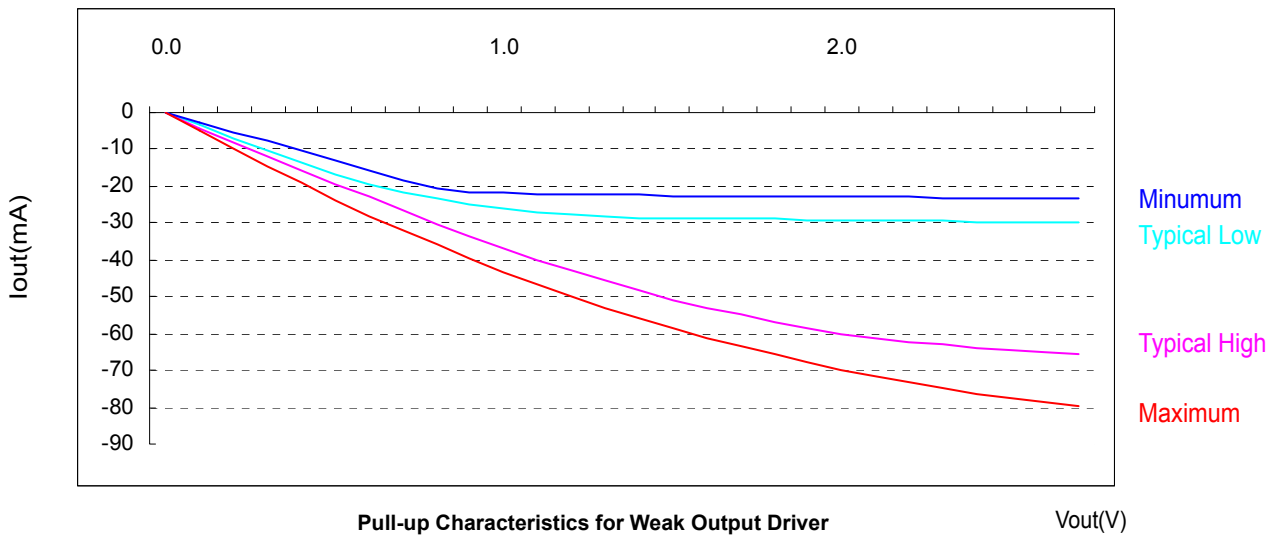

Figure 9. I/V characteristics for input/output buffers : Pull-down(above) and Pull-up(below)

[Table 9] Weak Driver Characteristics

Voltage (V)	Pull-down Current (mA)				Pull-up Current (mA)			
	Typical Low	Typical High	Minimum	Maximum	Typical Low	Typical High	Minimum	Maximum
0.1	3.4	3.8	2.6	5.0	-3.5	-4.3	-2.6	-5.0
0.2	6.9	7.6	5.2	9.9	-6.9	-8.2	-5.2	-9.9
0.3	10.3	11.4	7.8	14.6	-10.3	-12.0	-7.8	-14.6
0.4	13.6	15.1	10.4	19.2	-13.6	-15.7	-10.4	-19.2
0.5	16.9	18.7	13.0	23.6	-16.9	-19.3	-13.0	-23.6
0.6	19.6	22.1	15.7	28.0	-19.4	-22.9	-15.7	-28.0
0.7	22.3	25.0	18.2	32.2	-21.5	-26.5	-18.2	-32.2
0.8	24.7	28.2	20.8	35.8	-23.3	-30.1	-20.4	-35.8
0.9	26.9	31.3	22.4	39.5	-24.8	-33.6	-21.6	-39.5
1.0	29.0	34.1	24.1	43.2	-26.0	-37.1	-21.9	-43.2
1.1	30.6	36.9	25.4	46.7	-27.1	-40.3	-22.1	-46.7
1.2	31.8	39.5	26.2	50.0	-27.8	-43.1	-22.2	-50.0
1.3	32.8	42.0	26.6	53.1	-28.3	-45.8	-22.3	-53.1
1.4	33.5	44.4	26.8	56.1	-28.6	-48.4	-22.4	-56.1
1.5	34.0	46.6	27.0	58.7	-28.7	-50.7	-22.6	-58.7
1.6	34.3	48.6	27.2	61.4	-28.9	-52.9	-22.7	-61.4
1.7	34.5	50.5	27.4	63.5	-28.9	-55.0	-22.7	-63.5
1.8	34.8	52.2	27.7	65.6	-29.0	-56.8	-22.8	-65.6
1.9	35.1	53.9	27.8	67.7	-29.2	-58.7	-22.9	-67.7
2.0	35.4	55.0	28.0	69.8	-29.2	-60.0	-22.9	-69.8
2.1	35.6	56.1	28.1	71.6	-29.3	-61.2	-23.0	-71.6
2.2	35.8	57.1	28.2	73.3	-29.5	-62.4	-23.0	-73.3
2.3	36.1	57.7	28.3	74.9	-29.5	-63.1	-23.1	-74.9
2.4	36.3	58.2	28.3	76.4	-29.6	-63.8	-23.2	-76.4
2.5	36.5	58.7	28.4	77.7	-29.7	-64.4	-23.2	-77.7
2.6	36.7	59.2	28.5	78.8	-29.8	-65.1	-23.3	-78.8
2.7	36.8	59.6	28.6	79.7	-29.9	-65.8	-23.3	-79.7