

High Voltage Transistors

- We declare that the material of product compliance with RoHS requirements.

DEVICE MARKING AND ORDERING INFORMATION

Device	Marking	Package	Shipping
LMBTA42LT1G	1D	SOT-23	3000/Tape&Reel
LMBTA42LT3G	1D	SOT-23	10000/Tape&Reel
LMBTA43LT1G	M1E	SOT-23	3000/Tape&Reel
LMBTA43LT3G	M1E	SOT-23	10000/Tape&Reel

MAXIMUM RATINGS

Rating	Symbol	Value		Unit
		LMBTA42	LMBTA43	
Collector–Emitter Voltage	V_{CE0}	300	200	Vdc
Collector–Base Voltage	V_{CBO}	300	200	Vdc
Emitter–Base Voltage	V_{EBO}	6.0	6.0	Vdc
Collector Current — Continuous	I_C	50		mAdc

THERMAL CHARACTERISTICS

Characteristic	Symbol	Max	Unit
Total Device Dissipation FR– 5 Board, (1) $T_A = 25^\circ\text{C}$	P_D	225	mW
Derate above 25°C		1.8	mW/ $^\circ\text{C}$
Thermal Resistance, Junction to Ambient	$R_{\theta JA}$	556	$^\circ\text{C}/\text{W}$
Total Device Dissipation Alumina Substrate, (2) $T_A = 25^\circ\text{C}$	P_D	300	mW
Derate above 25°C		2.4	mW/ $^\circ\text{C}$
Thermal Resistance, Junction to Ambient	$R_{\theta JA}$	417	$^\circ\text{C}/\text{W}$
Junction and Storage Temperature	T_J, T_{stg}	-55 to +150	$^\circ\text{C}$

ELECTRICAL CHARACTERISTICS ($T_A = 25^\circ\text{C}$ unless otherwise noted.)

Characteristic	Symbol	Min	Max	Unit
----------------	--------	-----	-----	------

OFF CHARACTERISTICS

Collector–Emitter Breakdown Voltage(3) ($I_C = 1.0 \text{ mAdc}, I_E = 0$)	$V_{(BR)CEO}$			Vdc
LMBTA42		300	—	
LMBTA43		200	—	
Collector–Base Breakdown Voltage ($I_C = 100 \mu\text{Adc}, I_E = 0$)	$V_{(BR)CBO}$			Vdc
LMBTA42		300	—	
LMBTA43		200	—	
Emitter–Base Breakdown Voltage ($I_E = 100 \mu\text{Adc}, I_C = 0$)	$V_{(BR)EBO}$	6.0	—	Vdc
Collector Cutoff Current ($V_{CB} = 200\text{Vdc}, I_E = 0$)	I_{CBO}			μAdc
LMBTA42		—	0.1	
($V_{CB} = 160\text{Vdc}, I_E = 0$)	LMBTA43		0.1	
Emitter Cutoff Current ($V_{EB} = 6.0\text{Vdc}, I_C = 0$)	I_{EBO}			μAdc
LMBTA42		—	0.1	
($V_{EB} = 4.0\text{Vdc}, I_C = 0$)	LMBTA43		0.1	

1. FR–5 = 1.0 x 0.75 x 0.062 in.

2. Alumina = 0.4 x 0.3 x 0.024 in. 99.5% alumina.

3. Pulse Test: Pulse Width $\leq 300 \mu\text{s}$, Duty Cycle $\leq 2.0\%$.

LMBTA42LT1G
LMBTA43LT1G

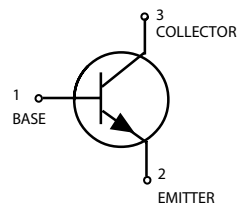
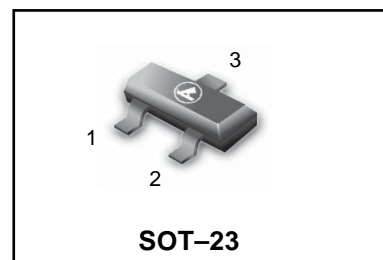

LMBTA42LT1G LMBTA43LT1G

ELECTRICAL CHARACTERISTICS (T A = 25°C unless otherwise noted) (Continued)

Characteristic	Symbol	Min	Max	Unit
----------------	--------	-----	-----	------

ON CHARACTERISTICS (3)

DC Current Gain (I _C = 1.0 mA, V _{CE} = 10 Vdc)	Both Types	25	—	—
(I _C = 10 mA, V _{CE} = 10 Vdc)	Both Types	40	—	—
(I _C = 30 mA, V _{CE} = 10 Vdc)	LMBTA42	40	—	—
	LMBTA43	40	—	—
Collector–Emitter Saturation Voltage (I _C = 20 mA, I _B = 2.0 mA)	LMBTA42	—	0.5	Vdc
	LMBTA43	—	0.5	Vdc
Base–Emitter Saturation Voltage (I _C = 20 mA, I _B = 2.0 mA)		—	0.9	Vdc

SMALL–SIGNAL CHARACTERISTICS

Current –Gain–Bandwidth Product (V _{CE} = 20 Vdc, I _C = 10mA, f = 100 MHz)		50	—	MHz
Collector – Base Capacitance (V _{CB} = 20 Vdc, I _E = 0, f = 1.0 MHz)	LMBTA42	—	3.0	pF
	LMBTA43	—	4.0	pF

3. Pulse Test: Pulse Width ≤300 μs, Duty Cycle ≤2.0%.

LMBTA42LT1G LMBTA43LT1G

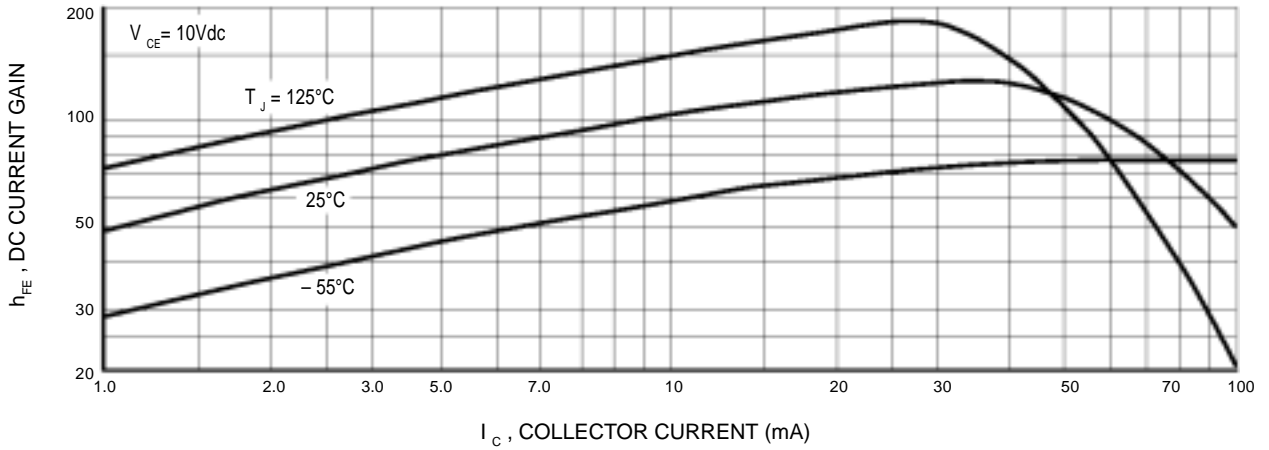

Figure 8. DC Current Gain

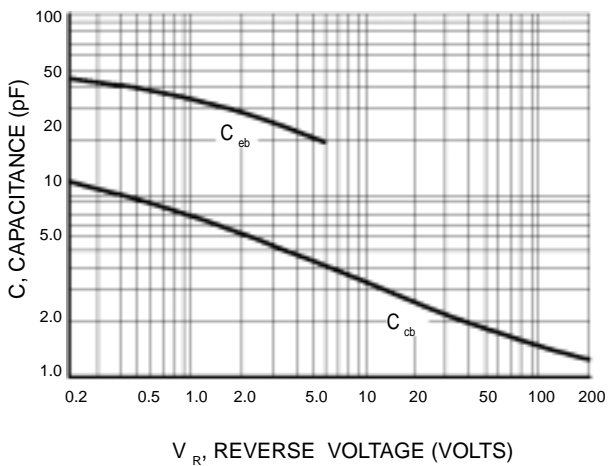

Figure 2. Capacitance

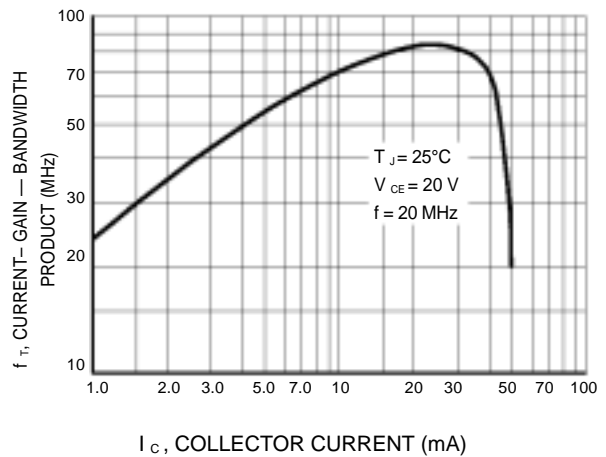

Figure 3. Current-Gain — Bandwidth Product

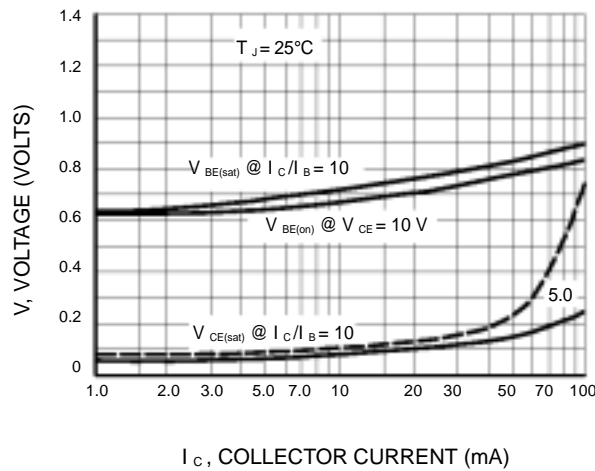
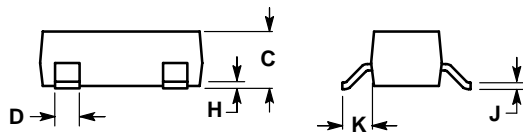
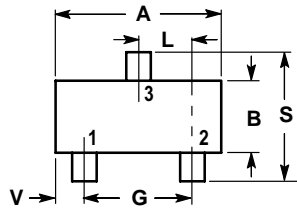

Figure 4. "On" Voltages

LMBTA42LT1G LMBTA43LT1G

SOT-23



NOTES:

1. DIMENSIONING AND TOLERANCING PER ANSI Y14.5M, 1982.
2. CONTROLLING DIMENSION: INCH.

DIM	INCHES		MILLIMETERS	
	MIN	MAX	MIN	MAX
A	0.1102	0.1197	2.80	3.04
B	0.0472	0.0551	1.20	1.40
C	0.0350	0.0440	0.89	1.11
D	0.0150	0.0200	0.37	0.50
G	0.0701	0.0807	1.78	2.04
H	0.0005	0.0040	0.013	0.100
J	0.0034	0.0070	0.085	0.177
K	0.0140	0.0285	0.35	0.69
L	0.0350	0.0401	0.89	1.02
S	0.0830	0.1039	2.10	2.64
V	0.0177	0.0236	0.45	0.60

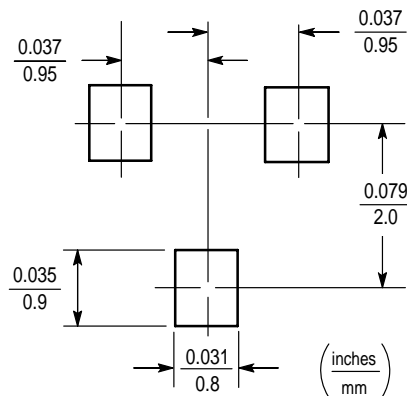

EMBOSSED TAPE AND REEL DATA FOR DISCRETES

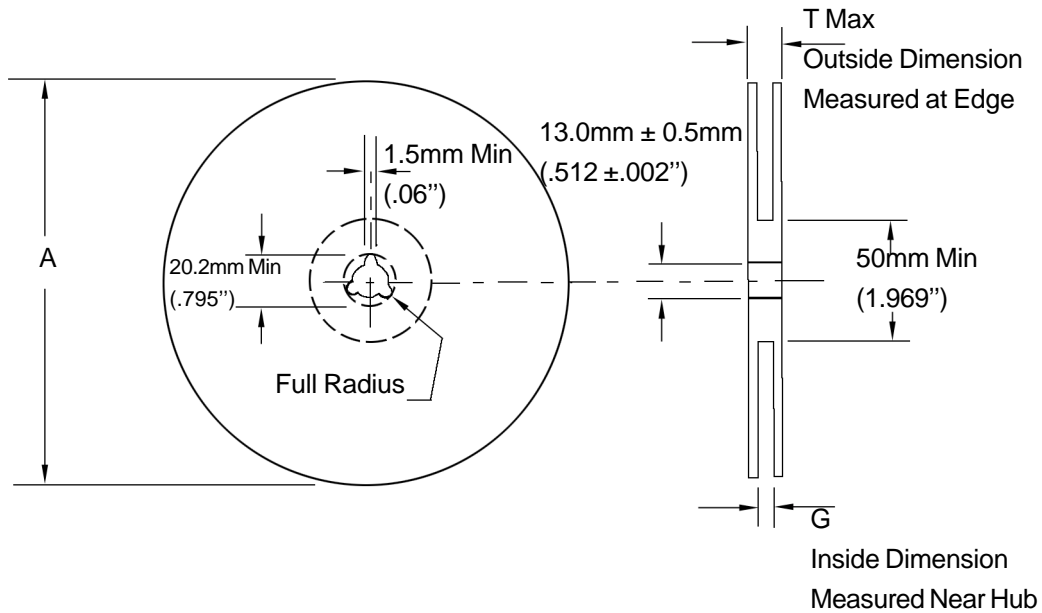

Size	A Max	G	T Max
8 mm	330mm (12.992")	8.4mm+1.5mm, -0.0 (.33"+.059", -0.00)	14.4mm (.56")

Reel Dimensions

Metric Dimensions Govern — English are in parentheses for reference only

Storage Conditions

Temperature: 5 to 40 Deg.C (20 to 30 Deg. C is preferred)

Humidity: 30 to 80 RH (40 to 60 is preferred)

Recommended Period: One year after manufacturing

(This recommended period is for the soldering condition only. The characteristics and reliabilities of the products are not restricted to this limitation)

Shipment Specification

