

Legacy NMA2004-A1D 100 Hz to 3 MHz



Specifications

RF Frequency	100 Hz to 3 MHz
Noise Output	82.2 dB Min ENR
Noise Spectral Density (N_o)	-91.8 dBm/Hz Min
Flatness	2 dB P-P Max
Peak Factor	5:1
Bias Voltage	15 V
Supply Current	12 mA Max
Impedance	50 ohms

Package and Connectivity

Construction	DIP 14 PIN
--------------	------------

Environmental

Operating Temperature	-55 to 95 °C
Storage Temperature	-65 to 125 °C

Notes

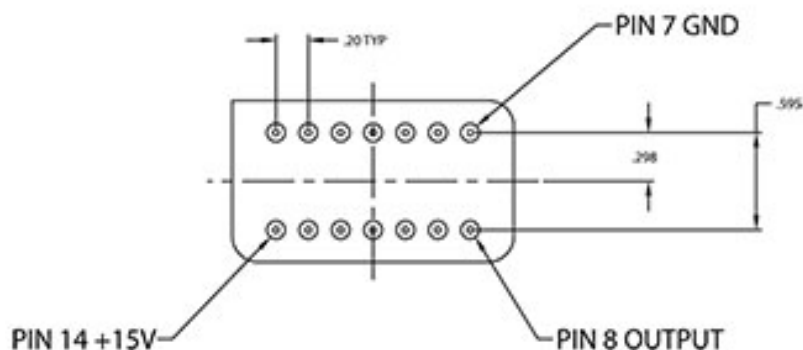
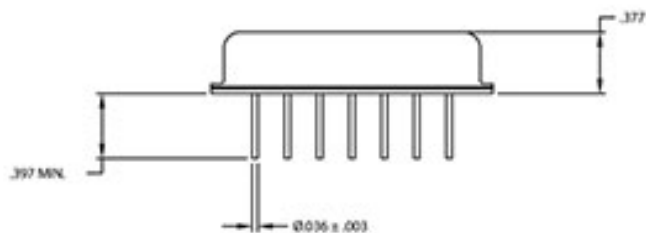
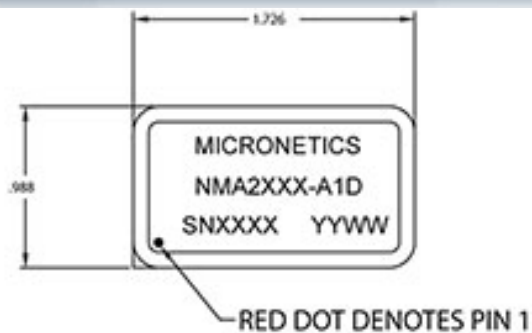

Specifications subject to change without notice

Micronetics, Inc. | Hudson, NH | Tel: 1-603-883-2900 | www.Micronetics.com

MICRONETICS

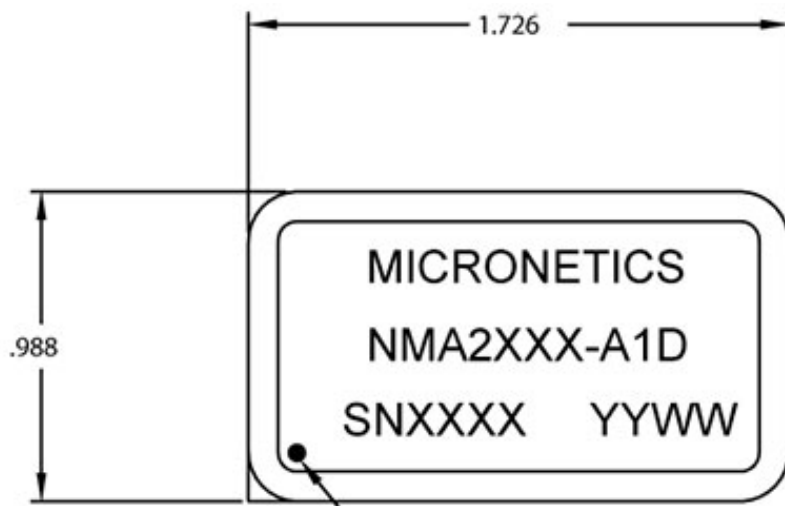

RED DOT DENOTES PIN 1

