

Solid State Relays

4-Pin SIP Package—VDC Input—VAC/VDC Output
OSSRD2001D and OSSRD2002A



Features:

- Molded Epoxy package
- Zero crossing circuit
- High Input/output Optical Isolation 4k Vrms
- Small size and light weight
- Can be installed directly on the P.C. board
- Fast switching time
- Non-contact switch

Approval Agency:

- UL Certification No: E321810

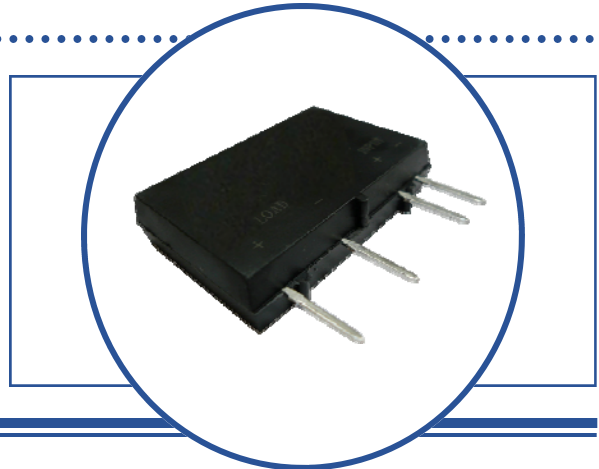

Description:

The OSSR Solid State Relay series are electronic controlled switches, they contain no moving parts. When voltage is applied to the input, a Light Emitting Diode or LED illuminates a Photosensor which controls the internal output circuit. The output circuit is utilized to drive high current loads. The input and output are optically isolated. The OSSR series incorporates a zero crossing circuit which minimizes current and noise surges due to resistive and inductive loads. Optek provides three different electrical configurations of the OSSR series: DC input – AC output, AC input – AC output and DC input – DC output. These configurations meet most industry applications.

The **OSSRD2001D** and **OSSRD2002A** are offered in a standard 4-pin SIP, Single In-Line Package, for PCB mounting applications. The package offers a light weight, compact and robust molded epoxy body with extended operating temperature range of up to 100°C.

The **OSSRD2001D** input circuit features a DC range from 4 to 24 VDC. The output consists of a photo darlington circuit featuring a load current rating of 3 Amps and a maximum load voltage of 100VDC and 30 Watts with normally open output.

The **OSSRD2002A** input circuit features a DC range from 4 to 32 VDC. The output consists of a Triac circuit featuring a load current rating of 3 to 40 Amps and a maximum load voltage of 250VAC with normally open output.

Applications:

- Temperature controlled systems
- Office equipment
- Motor controls
- Industrial Equipment
- Light controls systems
- Heater control
- Appliances
- HVAC temperature control
- Plastic molding
- Packaging industry



OPTEK reserves the right to make changes at any time in order to improve design and to supply the best product possible.

Solid State Relays

4-Pin SIP Package—VDC Input—VAC/VDC Output

OSSRD2001D and OSSRD2002A



Package Outline Dimensions: 4-Pin SIP

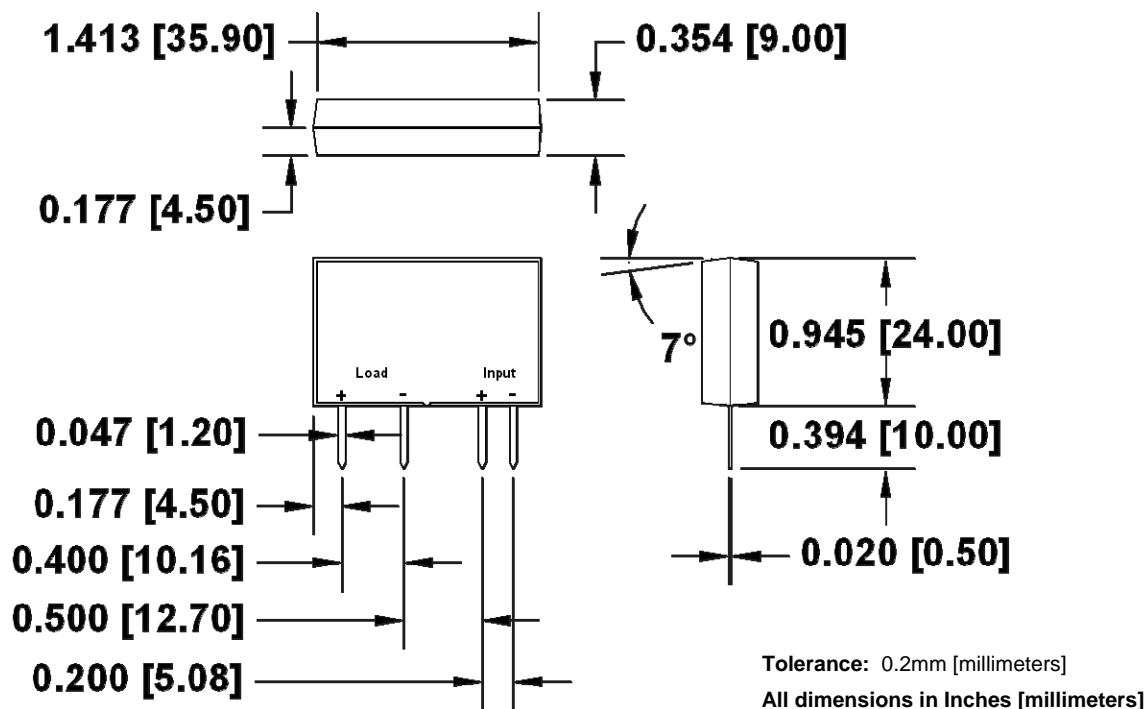

Schematic: Top View

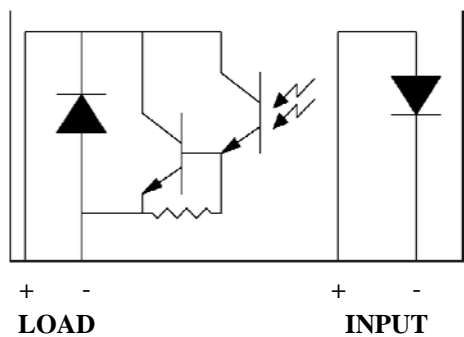

OSSRD2001D

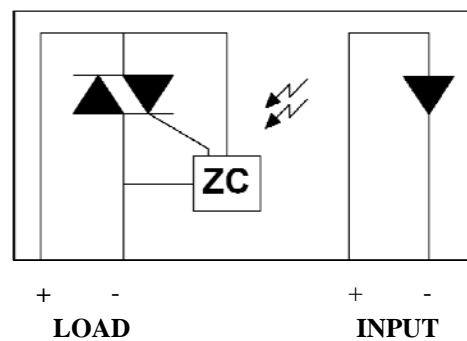

OSSRD2002A

Pin Configuration:

Part Number	Pin #			
	1	2	3	4
OSSRD2001D	A	K	C	E (Dar.)
OSSRD2002A	A	K	A1 (+)	A2 (-)

OPTEK reserves the right to make changes at any time in order to improve design and to supply the best product possible.

Solid State Relays

4-Pin SIP Package—VDC Input—VAC/VDC Output
OSSRD2001D and OSSRD2002A



VDC Input with VDC/VAC Output Devices Ordering Information

Part Number	Input	Min. Tgr Current Ift	Max. Output Current	Min. Ouput Current	Max. Vout	Min. Vout	Output Type	Br. Vol. Input to Output	Configuration
OSSRD2001D	4-24VDC	100mA	3A	0.05A	100VDC	-	DC	4000VAC	A K—C E (Darl.)
OSSRD2002A	4-32VDC	50mA	3A	0.05A	250VAC	50VAC	AC	4000VAC	A K—A1(+) A2(-)
Configuration: Definition of Terms LED Identification—Sensor Identification									
Configuration Information	LED	A = Anode				K = Cathode			
	Sensor	C = Collector				E = Emitter			
		A1(+) and A2(-) = Main Terminals of Triac							

Part Number Symbolization

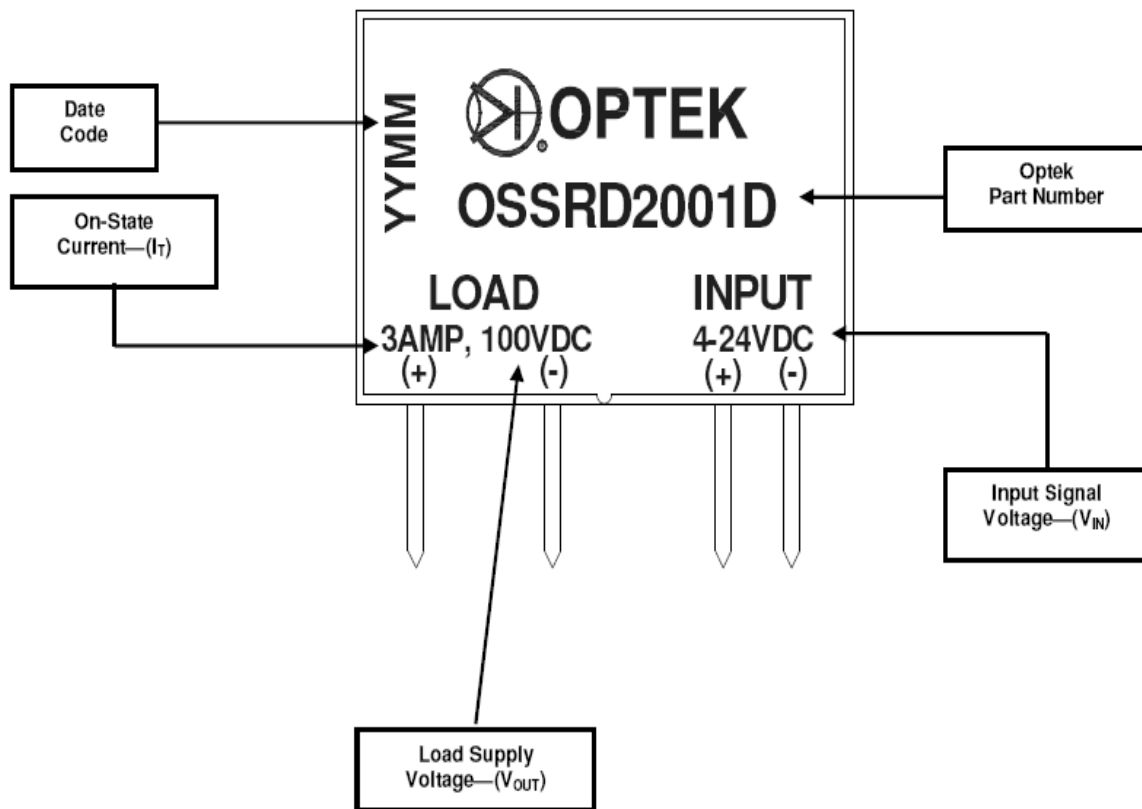

OPTEK reserves the right to make changes at any time in order to improve design and to supply the best product possible.

Solid State Relays

4-Pin SIP Package—VDC Input—VAC/VDC Output

OSSRD2001D and OSSRD2002A



Absolute Maximum Ratings ($T_A = 25^\circ\text{C}$ unless otherwise noted)

Storage Temperature OSSRD2001D, OSSRD2002A	-30° C to +125° C
Operating Temperature OSSRD2001D, OSSRD2002A	-30° C to +100° C
Isolation Voltage (Input to Output) OSSRD2001D, OSSRD2002A	4,000 Vrms
Soldering Temperature 10 sec. OSSRD2001D, OSSRD2002A	260° C

Input Diode

Input Signal Voltage—(V_{IN}) OSSRD2001D OSSRD2002A	4—24 VDC 4—32 VDC
Drop-out Voltage—(V_{do}) OSSRD2001D, OSSRD2002A	1 VDC
Output Power Dissipation—(P_c) OSSRD2001D	30 W

Output Triac

RMS On-State Current - (I_T) OSSRD2002A	3 Arms
Peak One Cycle Surge Current - (I surge) OSSRD2001D @ 50 μ S OSSRD2002A @ 8.3ms	9 A 30 A
Repetitive Peak-Off State Voltage—(V_{DRM}) OSSRD2002A	600 V
Operating Frequency—(f) OSSRD2002A	47—70 Hz
Critical Rate of Rise of On-State Current—(di/dt) OSSRD2002A	50 A/ μ S
Load Supply Voltage—(V_{OUT}) OSSRD2002A	250 Vrms AC

Output Photo Darlington

Collector Voltage - (V_{CEO}) OSSRD2001D	100 VDC
Output Current - (I_o) OSSRD2001D	3 A

OPTEK reserves the right to make changes at any time in order to improve design and to supply the best product possible.

Solid State Relays

4-Pin SIP Package—VDC Input—VAC/VDC Output

OSSRD2001D and OSSRD2002A



Electrical Characteristics (T_A = 25° C unless otherwise noted)

SYMBOL	PARAMETER	MIN	TYP	MAX	UNITS	TEST CONDITIONS
Input Diode						
V _{PU}	Pick-up Voltage OSSRD2001D, OSSRD2002A	-	-	4	VDC	I _T = 1Arms
I _{IN}	Input Current OSSRD2001D OSSRD2002A	- 5	- -	25 12	mA	V _{IN} = 4 - 24 V V _{IN} = 4 - 32 V
C _T	Terminal Capacitance OSSRD2001D	-	30	-	pF	V=0, f=1kHz

Output Triac

V _T	On-State Voltage OSSRD2002A	-	-	1.5	Vrms	I _T = 1Arms
I _{OP}	Operating Current OSSRD2002A	50	-	-	mArms	V _{out} = 240Vrms
I _{LEAK}	Leakage Current OSSRD2002A	-	-	7	mArms	V _{out} = 240Vrms
dv/dt	Critical Rate of Rise of Off-State Voltage OSSRD2002A	50	200	-	V/μs	See Note 1.
-	Zero-Cross Voltage OSSRD2002A	-	Yes	-	-	-
V _{OUT}	Load Voltage Rating OSSRD2002A	50	-	280	VAC	I _T = 50mArms MIN
I _{FT}	Minimum Trigger Current OSSRD2002A	-	-	10 25	mA	V _{DRM} = 600 V
Riso	Isolation resistance Input to Output OSSRD2002A	10 ¹⁰	-	-	Ω	DC500 V
T _{ON}	Turn-on Time OSSRD2002A	-	-	8.3	mS	60Hz AC
T _{OFF}	Turn-off Time OSSRD2002A	-	-	8.3	mS	60Hz AC
Rth (j-C)	Thermal Resistance (between junction and case)	-	1.3	-	°C/W	-

Note1: Output (dv/dt) protection is provided in all models, and they are designed to switch resistive or inductive loads to 0.2 factor. The dv/dt rating is based on source impedance of 50 ohms.

OPTEK reserves the right to make changes at any time in order to improve design and to supply the best product possible.

Solid State Relays

4-Pin SIP Package—VDC Input—VAC/VDC Output

OSSRD2001D and OSSRD2002A



Electrical Characteristics ($T_A = 25^\circ\text{C}$ unless otherwise noted)

SYMBOL	PARAMETER	MIN	TYP	MAX	UNITS	TEST CONDITIONS
Output Photodiode						
BV_{CEO}	Collector-Emitter Breakdown Voltage OSSRD0001D	100	-	-	Vrms	$I_F = 0\text{mA}$
I_{LEAK}	Output Leak Current OSSRD0001D	-	-	1.5	μA	$I_F = 0\text{mA}, V = 100\text{V}$
I_C	Collector Current OSSRD0001D	0.05	-	3	A	$I_F = 1\text{mA}, V_{CE} = 2\text{V}$
$V_{CE(sat)}$	Collector-Emitter Saturation Voltage OSSRD0001D	-	Yes	-	-	$I_F = 20\text{mA}, I_C = 100\text{mA}$
Riso	Isolation Resistance OSSRD0001D	10^{10}	-	-	Ω	DC500 V
C_r	Floating Capacitance OSSRD0001D	-	-	3	pF	$V = 0, f = 1\text{MHz}$
f_c	Cut-Off Frequency OSSRD0001D	2	-	-	Hz	$V_{CE} = 2\text{V}, I_C = 200\text{mA}, R_L = 200\text{mA}$
t_f	Response Time (Rise) OSSRD0001D	-	-	500	μS	$V_{CE} = 2\text{V}, I_C = 20\text{mA}, R_L = 200\text{mA}$
t_r	Response Time (Fall) OSSRD0001D	-	-	200	μS	$V_{CE} = 2\text{V}, I_C = 20\text{mA}, R_L = 200\text{mA}$

OPTEK reserves the right to make changes at any time in order to improve design and to supply the best product possible.

Solid State Relays

4-Pin SIP Package—VDC Input—VAC/VDC Output

OSSRD2001D and OSSRD2002A



OSSRD2001D

Characteristic Data Curves

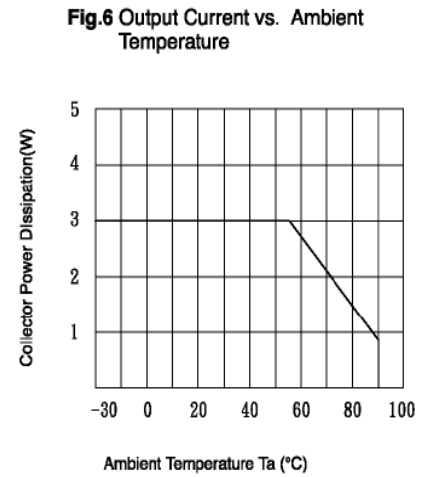
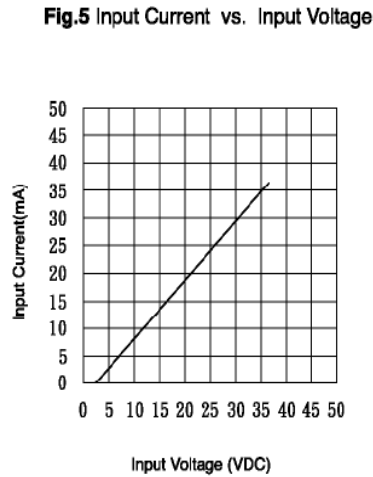
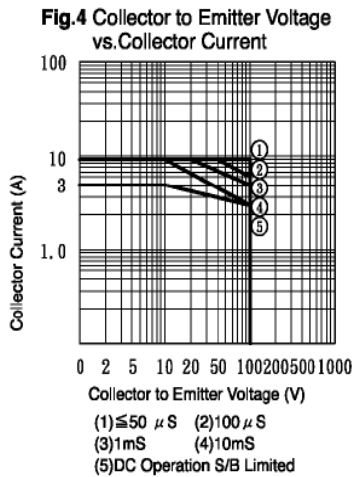
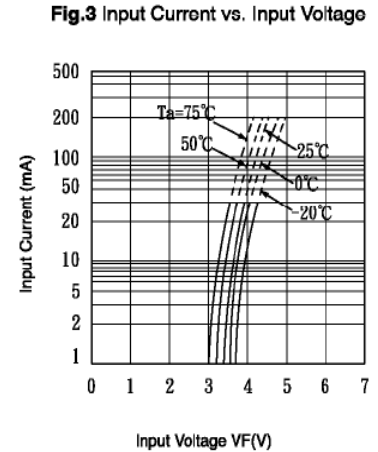
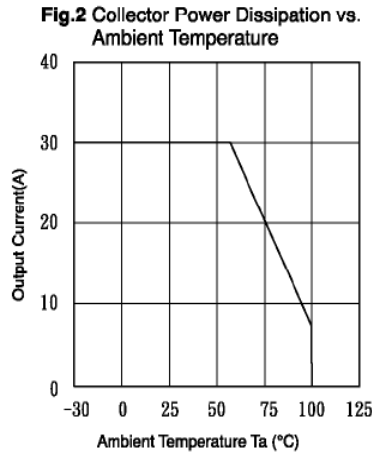
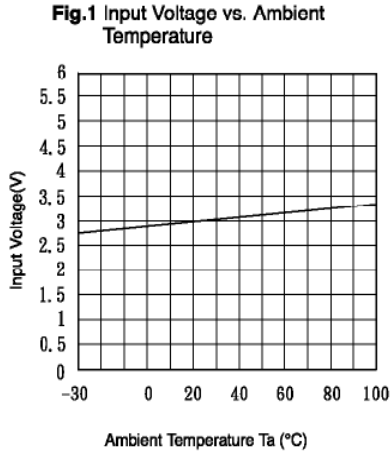

Fig.7 Action Waveform

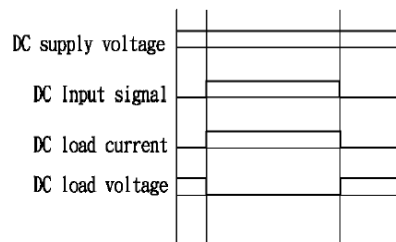
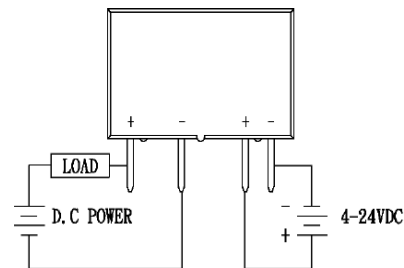

Fig.8 WIRING DIAGRAM



OPTEK reserves the right to make changes at any time in order to improve design and to supply the best product possible.

Solid State Relays

4-Pin SIP Package—VDC Input—VAC/VDC Output

OSSRD2001D and OSSRD2002A



OSSRD2002A

Characteristic Data Curves

Fig.1 RMS On-state Current vs. Ambient Temperature

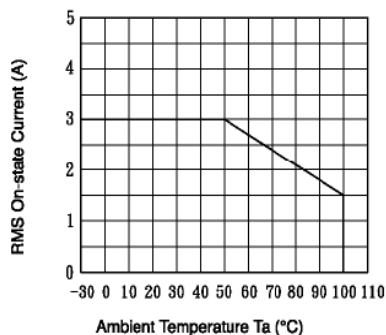

Fig.2 Surge Current vs. Time

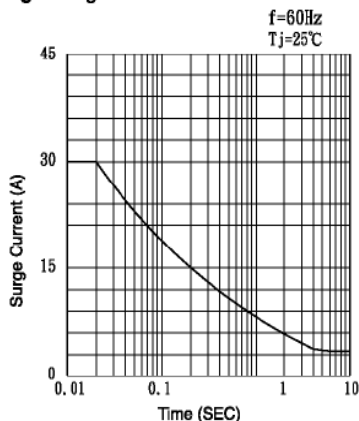

Fig.3 Open Circuit Leak Current vs. Supply Voltage

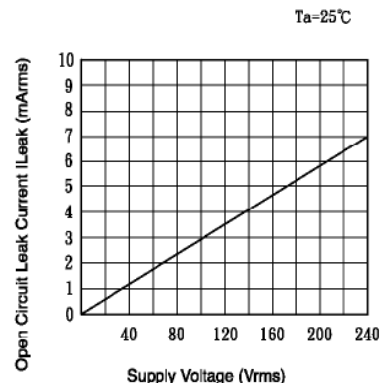

Fig.4 RMS On-state Current vs. Case Temperature

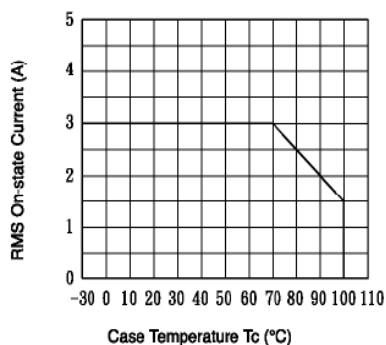

Fig.5 Input Voltage vs. Ambient Temperature

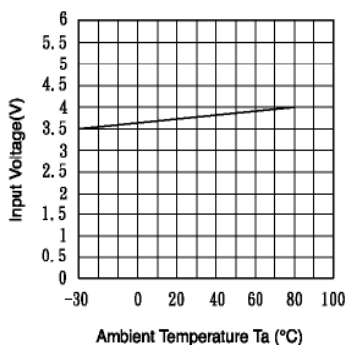

Fig.6 Input Current vs. Input voltage

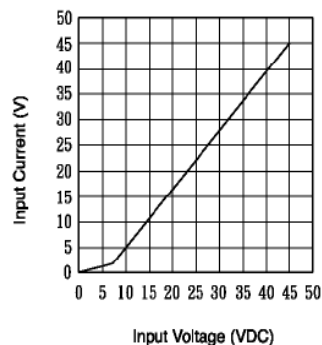

Fig.7 Action waveform

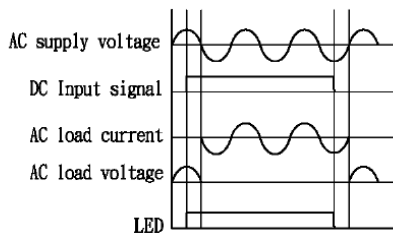
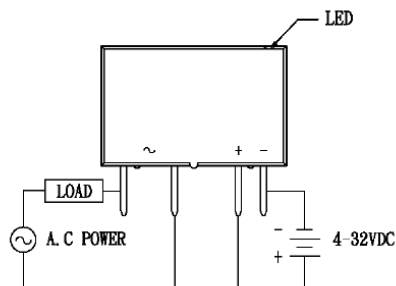

Fig.8 WIRING DIAGRAM



OPTEK reserves the right to make changes at any time in order to improve design and to supply the best product possible.

Solid State Relays

4-Pin SIP Package—VDC Input—VAC/VDC Output

OSSRD2001D and OSSRD2002A



Quality and Reliability Requirements

Parameter	Failure Criteria	Test Conditions
Room Temperature Operating Life (for light emitting diodes only)	± 20%	T _A = 25°C, I _F = 60mA or max. rated, Time = 1000 hours
High Humidity, High Temperature Reverse Bias	± 20%	JEDEC, Method A101-B T _A = 85°C, Humidity = 85%RH, Time = 1000 hours
High Temperature Forward Bias	± 20%	JEDEC, Method A108-A T _A = 70°C, I _F = 20mA, Time = 1000 hours
Autoclave	0 Fail	T _A = 121°C, Pressure = 15psi, Humidity = 100%
IR Reflow / Solderability Test	0 Fail	JEDEC (J-STD-020) / MIL-STD-883E, Method 2003.7
MTTF @ 90% confidence	150,000 Min.	@ 25°C, 25mADC
Moisture Sensitivity Level	MSL 1	per JDEC stnd J-STD-020B
Glass Transition of body	125°C Min.	DSC test method
Temperature Humidity-Bias	± 20%	85°C, 85%RH, 500Hrs, 80% min I _{ceo}
Temperature Cycle	± 20%	per Method 1010.7 of MIL-STD-883E
High Temperature Storage	± 20%	85°C, 500Hrs

Label Identification:

DESCRIPTION:

Size: 3" (7.4 cm) X 2.2" (5.5 cm)
 Lettering shall be black on white background.
 Format shall be as:

Notes:

1. The DATE CODE is a 4-digit code for date of manufacture where YY is the last two digits of the year, and WW is week number of manufacture.
2. The LOT I.D. is the manufacturing location lot identification where Y is the year of manufacture, NNNN is a sequential lot identifier, and DDD is the day of the year of manufacture. – or use equivalent label format.

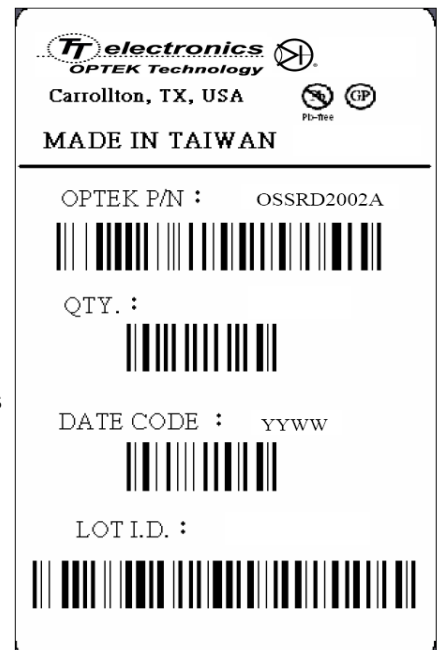

OPTEK reserves the right to make changes at any time in order to improve design and to supply the best product possible.

Solid State Relays

4-Pin SIP Package—VDC Input—VAC/VDC Output

OSSRD2001D and OSSRD2002A



Packaging Information:

Optek's Solid-State Relays Part Numbers (4-Pin SIP)		Packaging Quantities	Tubes		Inner		Medium Carton			Large Carton		
			Qty	Weight (g)	Qty	Weight (kg)	Qty	Net Weight (kg)	Gross Weight (kg)	Qty	Net Weight (kg)	Gross Weight (kg)
		Package Type	53.5 x 7.0 x 7.5 cm		55.5 x 30.7 x 16.5 cm			55.5 x 30.7 x 23.5 cm				
SSR	OSSRD2001D, OSSRD2002A	4 Pin SIP (24mm x 37mm)	10	213	80	1.80	640	14.4	15.4	960	21.6	22.9
	OSRRD1001A - OSSRD1006A	4 Pin SIP (32mm x 24mm)	20	421	80	1.90	640	15.2	16.2	960	22.8	24.1

Optek's Solid-State Relays Part Numbers (Panel Mounts)		Packaging Quantities	Trays		Small Carton			Medium Carton			Large Carton		
			Qty	Weight (g)	Qty	Net Weight (kg)	Gross Weight (kg)	Qty	Net Weight (kg)	Gross Weight (kg)	Qty	Net Weight (kg)	Gross Weight (kg)
		Package Type	36 x 20 x 37 cm		37 x 21 x 11 cm			37 x 21 x 17 cm			37 x 21 x 32 cm		
SSR	OSSRD0001A - OSSRD0006A OSSRA0007A - OSSRA0012A	Panel Mounts (42.5mm x 58mm)	10	920	30	2.80	3.3	50	4.7	5.4	100	9.5	10.5

Tray and Carton Packaging Specifications:

Tube Packaging Dimensions

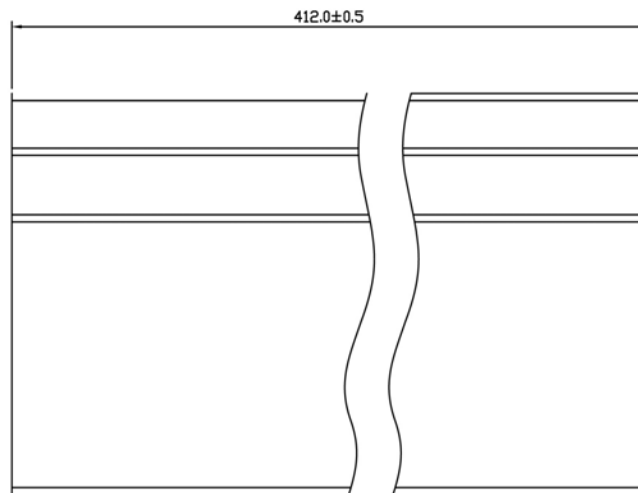
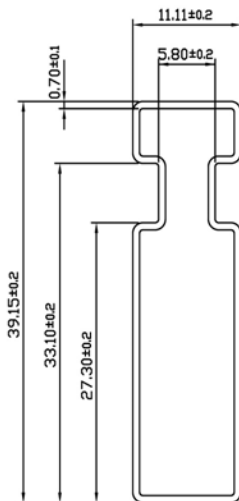

All dimensions in millimeters

OPTEK reserves the right to make changes at any time in order to improve design and to supply the best product possible.

Solid State Relays

4-Pin SIP Package—VDC Input—VAC/VDC Output

OSSRD2001D and OSSRD2002A



Tray and Carton Packaging Specifications (Cont.):

Carton Packaging Dimensions

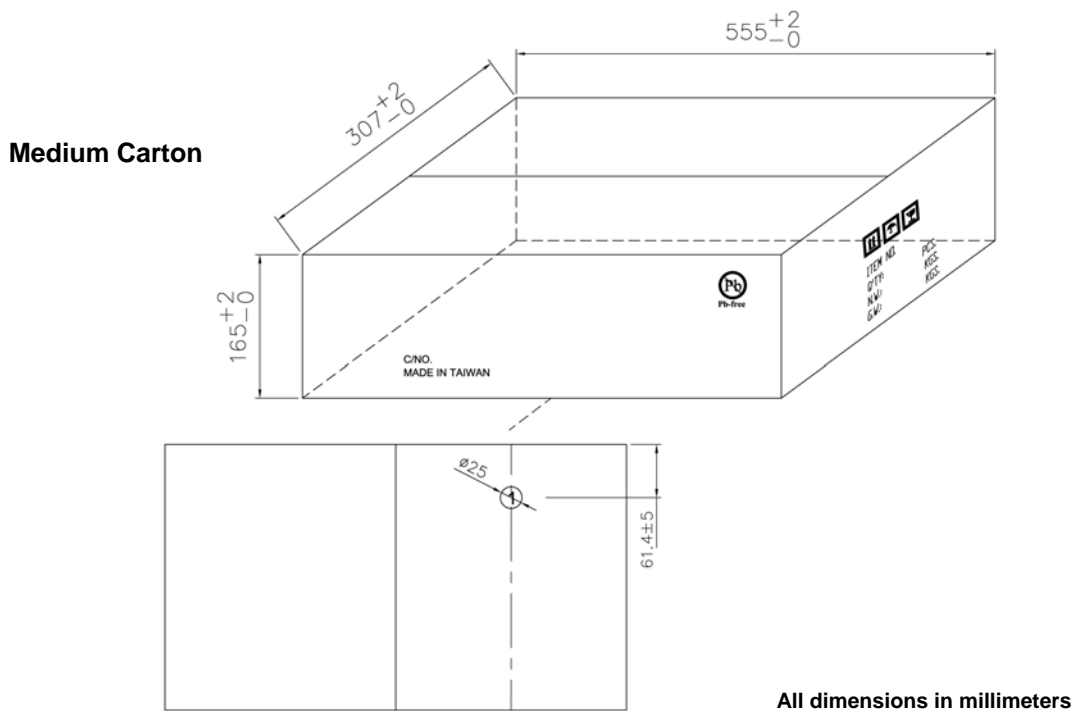
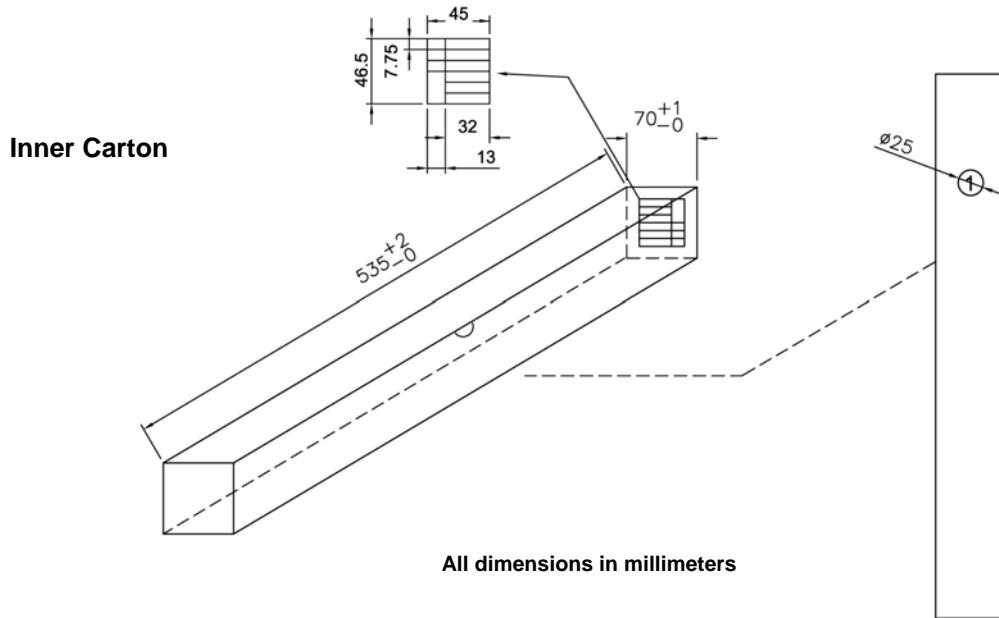

OPTEK reserves the right to make changes at any time in order to improve design and to supply the best product possible.

Solid State Relays

4-Pin SIP Package—VDC Input—VAC/VDC Output

OSSRD2001D and OSSRD2002A



Tray and Carton Packaging Specifications (Cont.):

Carton Packaging Dimensions

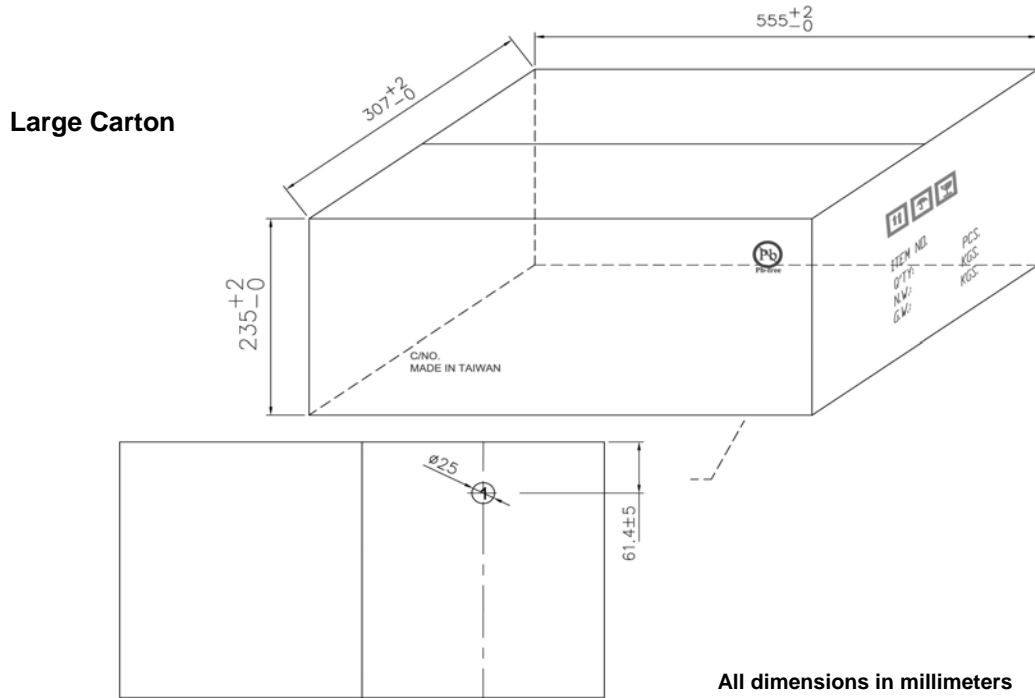

OPTEK reserves the right to make changes at any time in order to improve design and to supply the best product possible.