

Typical UL508 Application

Power Circuit of a UL508A Panel

Altech's V-EA UL508 Manual Motor Controllers are approved for Group Installations

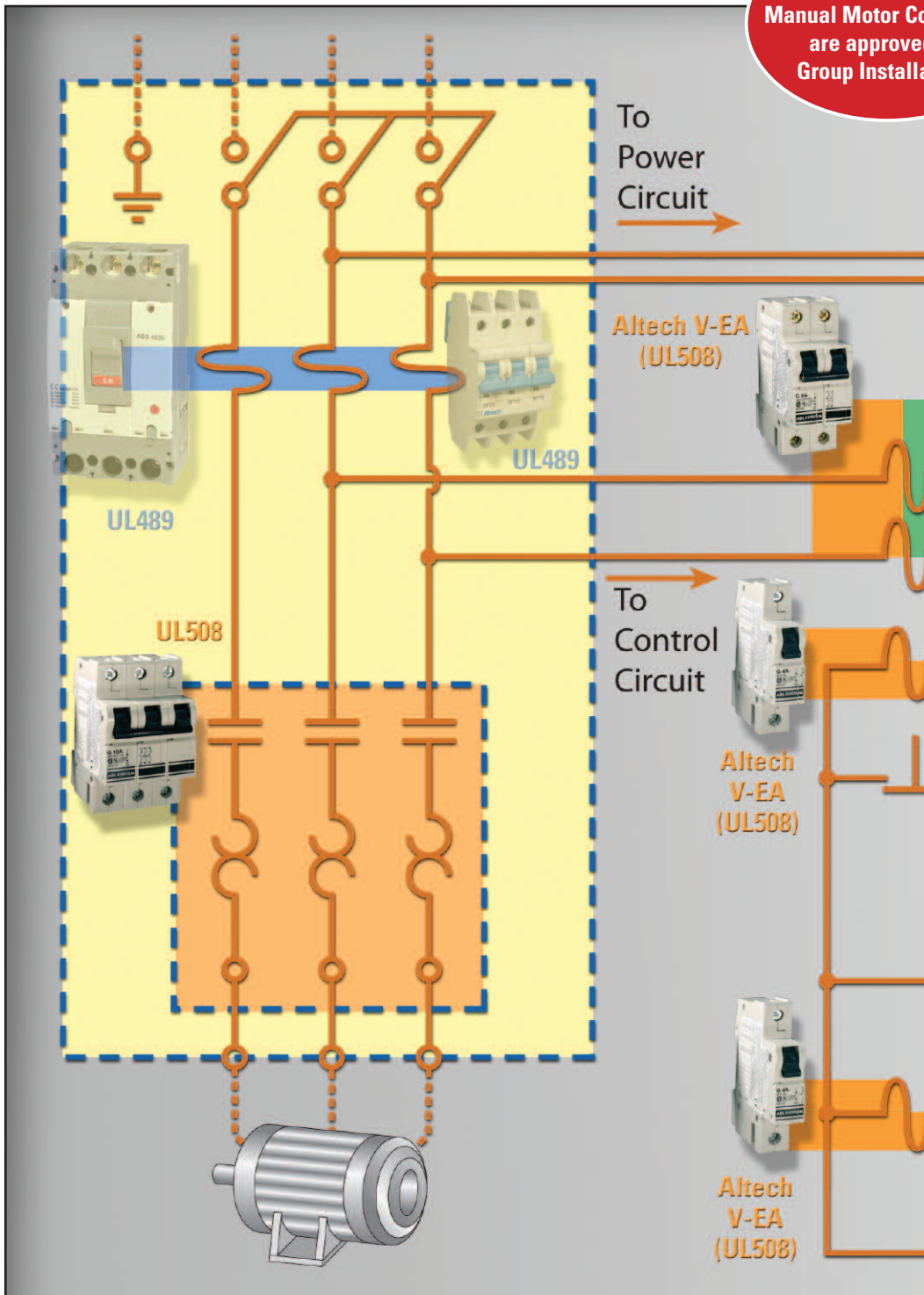

Disclaimer: This an application example. Installation should be done by a qualified electrician under the guidance of UL/NEC[®] specifications..

V-EA Series

UL 508 listed
E137938

SP C22.2 No.14 certified
LR104391

UL508 Listed
Manual Motor Controller
“Suitable as Motor Disconnect”

- DIN Rail Mounted
- 17.5mm width per pole
- Thermal Magnetic
- 480Y/277V AC, 50/60Hz
- 10kA Short Circuit Withstand Capacity
- Applications Include:
 - AC Motor Starting, Across the Line
 - AC General Use
 - AC Resistance
 - AC Discharge Lamps (Ballast)
 - AC Incandescent Lamps (Tungsten)

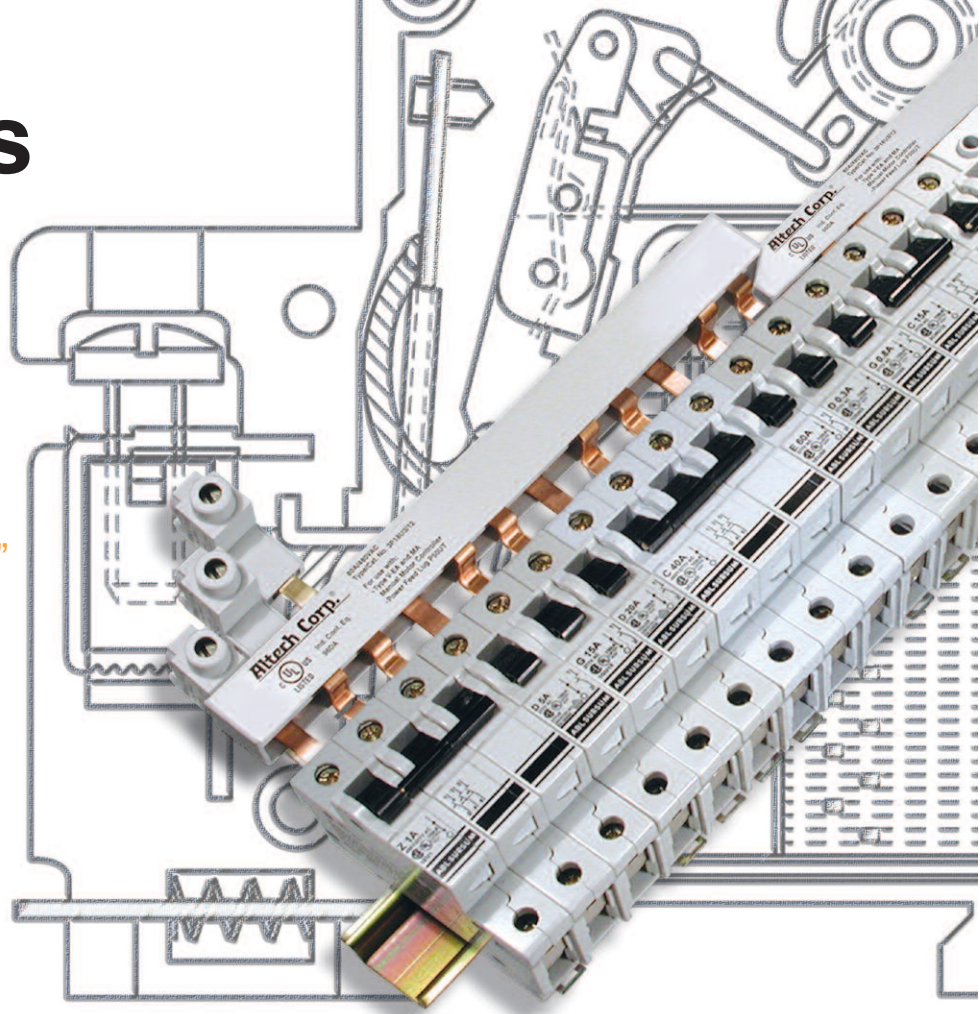

Voltage Rating	480Y/277VAC 0.3-25A: 1 pole - 42VDC; 2 Pole - 80VDC 30-60A: 1 pole - 24VDC; 2 Pole - 60VDC
Short Circuit Withstand Rating (UL/CSA - Ratings)	0.3-60A (RC): 10kA with UL-listed RK5 back-up fuse or MCCB
Group Short Circuit Withstand Rating (UL/CSA - Ratings)	0.3-10A (RC): 10kA; 13-60A (RC): 5kA no branch circuit protection required
Interrupting Capacity (VDE - Ratings)	0.3-63A (RC): 10kA
Calibration Temperature	40°C (104°F)
Terminal Size Acceptability	Top: 18-3 AWG; Bottom: 18-2 AWG
Terminal Torque	20 lb.in.
Terminal Protection Degree	IP20
Horse Power Ratings	see page 34
Mechanical Endurance Ratings	see page 35

SHORT CIRCUIT WITHSTAND RATINGS FOR V-EA MANUAL MOTOR CONTROLLER

Trip Curve	Backup Protection Amp Range	UL-Listed RK5-Fuse up to 10kA	UL-Listed MCCB up to 10kA	No BCP Required up to:
all	0.3 - 10A	4xRC* min 15A, max 70A	4xRC* min 15A, max 70A	10kA
all	12 - 30/32A	4xRC* max 125A	4xRC* max 125A	5kA
all	40 - 50A	4xRC* max 200A	4xRC* max 200A	5kA
all	60 / 63A	4xRC* max 250A	4xRC* max 250A	5kA

*up to nearest rated current

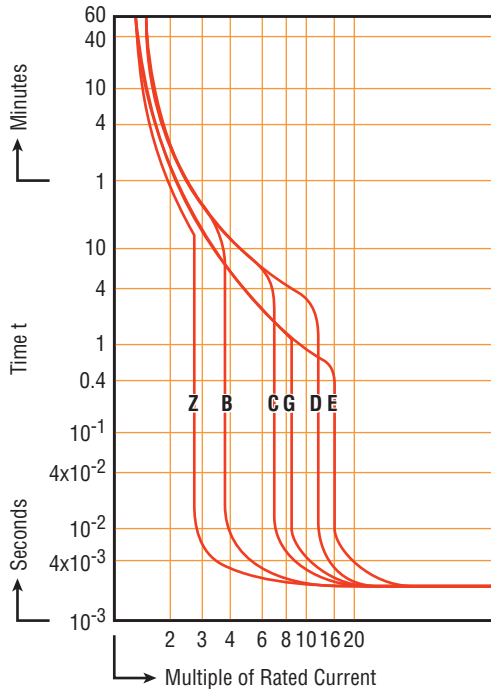

Time versus Current Trip Curve

For the exact trip curve, please refer to pages 32-33.

Dimensions in mm side view

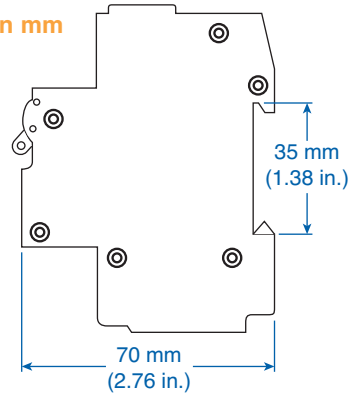

1 POLE

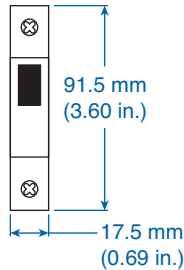

2 POLE

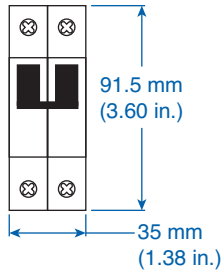

3 POLE

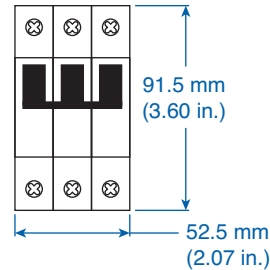

Trip-Characteristics*				Applications											
Characteristic Trip Boundaries				Lighting Wiring Protection Control Circuits	Business Equipment Appliances	Transformers	Power Supplies Heaters	Motors				General Electronics	Solenoid	Semi- conductors / devices with low surge- current and short circuit withstand capabilities	Reactive Load
Thermal Trip		Magnetic Trip						General	Low Inrush	High Inrush	High Efficiency				
Must not Trip >100ms	Must Trip <1hr	Must not Trip >100ms	Must Trip at 100ms												
B-Characteristics															
1.13xRC	1.45xRC	3xRC	5xRC												
C-Characteristics															
1.13xRC	1.45xRC	5xRC	10xRC												
D-Characteristics															
1.13xRC	1.45xRC	10xRC	16xRC												
E-Characteristics															
1.05xRC	1.35xRC	14xRC	18xRC												
G-Characteristics															
1.05xRC	1.35xRC	8xRC	10xRC												
Z-Characteristics															
1.05xRC	1.35xRC	2xRC	3xRC												

*The value of each characteristic is shown vertically beneath its corresponding heading.



Warning!

This information should only be used as a selection guide. The use of a Miniature Circuit Breaker/Manual Motor Controller in an application with a certain Trip-Characteristic always requires prototype testing! It is the responsibility of the circuit design engineer to select the appropriate Miniature Circuit Breaker/Manual Motor Controller for his specific application.

B-Trip Characteristic



UL508 Listed
E137938

Application Examples:

Business equipment, wiring protection, lighting, appliances, control circuits, some motors and some electronic applications. Relatively long thermal trip delay but low magnetic trip point.



One Pole

Standard Pack: 12

Weight:

0.3A - 32A

1.68kg (3.7 lb.)

40A - 63A

1.92kg (4.23 lb.)

Rated Current	Type/ Cat. No.	Approvals
1.0A	1BU1	UL SF
1.6A	1BU1.6	UL SF
2.0A	1BU2	UL SF
2.5A	1BU2.5	UL SF
3.0A	1BU3	UL SF
3.5A	1BU3.5	UL SF
4.0A	1BU4	UL SF
5.0A	1BU5	UL SF
6.0A	1BU6	UL SF VDE
8.0A	NA	
10A	1BU10	UL SF VDE
12A	NA	
12.5A	NA	
13A	1BU13	UL SF VDE
15A	1BU15	UL SF
16A	1BU16	UL SF VDE
20A	1BU20	UL SF VDE
25A	1BU25	UL SF VDE
30A	1BU30	UL SF
32A	1BU32	UL SF
40A	1BU40	UL SF
50A	1BU50	UL SF
60A	1BU60	UL SF
63A	1BU63	



One Pole plus neutral

Standard Pack: 6

Weight:

0.3A - 32A

1.56kg (3.44 lb.)

40A - 63A

1.74kg (3.84 lb.)

Rated Current	Type/ Cat. No.	Approvals
1.0A	2BNU1	UL SF
1.6A	2BNU1.6	UL SF
2.0A	2BNU2	UL SF
2.5A	2BNU2.5	UL SF
3.0A	2BNU3	UL SF
3.5A	2BNU3.5	UL SF
4.0A	2BNU4	UL SF
5.0A	2BNU5	UL SF
6.0A	2BNU6	UL SF VDE
8.0A	NA	
10A	2BNU10	UL SF VDE
12A	NA	
12.5A	NA	
13A	2BNU13	UL SF VDE
15A	2BNU15	UL SF
16A	2BNU16	UL SF VDE
20A	2BNU20	UL SF VDE
25A	2BNU25	UL SF VDE
30A	2BNU30	UL SF
32A	2BNU32	UL SF
40A	2BNU40	UL SF
50A	2BNU50	UL SF
60A	2BNU60	UL SF
63A	2BNU63	



Two Pole

Standard Pack: 6

Weight:

0.3A - 63A

1.68kg (3.7 lb.)

Rated Current	Type/ Cat. No.	Approvals
1.0A	2BU1	UL SF
1.6A	2BU1.6	UL SF
2.0A	2BU2	UL SF
2.5A	2BU2.5	UL SF
3.0A	2BU3	UL SF
3.5A	2BU3.5	UL SF
4.0A	2BU4	UL SF
5.0A	2BU5	UL SF
6.0A	2BU6	UL SF VDE
8.0A	NA	
10A	2BU10	UL SF VDE
12A	NA	
12.5A	NA	
13A	2BU13	UL SF VDE
15A	2BU15	UL SF
16A	2BU16	UL SF VDE
20A	2BU20	UL SF VDE
25A	2BU25	UL SF VDE
30A	2BU30	UL SF
32A	2BU32	UL SF
40A	2BU40	UL SF
50A	2BU50	UL SF
60A	2BU60	UL SF
63A	2BU63	



Three Pole

Standard Pack: 4

Weight:

0.3A - 63A

1.68kg (3.7 lb.)

Rated Current	Type/ Cat. No.	Approvals
1.0A	3BU1	UL SF
1.6A	3BU1.6	UL SF
2.0A	3BU2	UL SF
2.5A	3BU2.5	UL SF
3.0A	3BU3	UL SF
3.5A	3BU3.5	UL SF
4.0A	3BU4	UL SF
5.0A	3BU5	UL SF
6.0A	3BU6	UL SF VDE
8.0A	NA	
10A	3BU10	UL SF VDE
12A	NA	
12.5A	NA	
13A	3BU13	UL SF VDE
15A	3BU15	UL SF
16A	3BU16	UL SF VDE
20A	3BU20	UL SF VDE
25A	3BU25	UL SF VDE
30A	3BU30	UL SF
32A	3BU32	UL SF
40A	3BU40	UL SF
50A	3BU50	UL SF
60A	3BU60	UL SF
63A	3BU63	



For ring tongue terminal version, replace "U" with "R" in part number. For example **1BR20** instead of **1BU20**.

C-Trip Characteristic



UL508 Listed
E137938

Application Examples:

Low inrush motors, lighting, wiring protection, appliances, business equipment, and control circuit applications. Relatively long thermal trip delay and medium magnetic trip point.



One Pole

Standard Pack: 12

Weight:

0.3A - 32A

1.68kg (3.7 lb.)

40A - 63A

1.92kg (4.23 lb.)

Rated Current	Type/ Cat. No.	Approvals
0.3A	1CU03	UL SF A
0.5A	1CU05	UL SF A
0.75A	1CU075	UL SF A
0.8A	NA	
1.0A	1CU1	UL SF A
1.6A	1CU1.6	UL SF A
2.0A	1CU2	UL SF A
2.5A	1CU2.5	UL SF A
3.0A	1CU3	UL SF A
3.5A	1CU3.5	UL SF A
4.0A	1CU4	UL SF A
5.0A	1CU5	UL SF A
6.0A	1CU6	UL SF A
8.0A	1CU8	UL SF A
10A	1CU10	UL SF A
12A	NA	
12.5A	NA	
13A	1CU13	UL SF A
15A	1CU15	UL SF
16A	1CU16	UL SF A
20A	1CU20	UL SF A
25A	1CU25	UL SF A
30A	1CU30	UL SF
32A	1CU32	UL SF
40A	1CU40	UL SF
50A	1CU50	UL SF
60A	1CU60	UL SF
63A	1CU63	



One Pole plus neutral

Standard Pack: 6

Weight:

0.3A - 32A

1.56kg (3.44 lb.)

40A - 63A

1.74kg (3.84 lb.)

Rated Current	Type/ Cat. No.	Approvals
0.3A	2CNU03	UL SF A
0.5A	2CNU05	UL SF A
0.75A	2CNU075	UL SF A
0.8A	NA	
1.0A	2CNU1	UL SF A
1.6A	2CNU1.6	UL SF A
2.0A	2CNU2	UL SF A
2.5A	2CNU2.5	UL SF A
3.0A	2CNU3	UL SF A
3.5A	2CNU3.5	UL SF A
4.0A	2CNU4	UL SF A
5.0A	2CNU5	UL SF A
6.0A	2CNU6	UL SF A
8.0A	2CNU8	UL SF A
10A	2CNU10	UL SF A
12A	NA	
12.5A	NA	
13A	2CNU13	UL SF A
15A	2CNU15	UL SF
16A	2CNU16	UL SF A
20A	2CNU20	UL SF A
25A	2CNU25	UL SF A
30A	2CNU30	UL SF
32A	2CNU32	UL SF
40A	2CNU40	UL SF
50A	2CNU50	UL SF
60A	2CNU60	UL SF
63A	2CNU63	



Two Pole

Standard Pack: 6

Weight:

0.3A - 63A

1.68kg (3.7 lb.)

Rated Current	Type/ Cat. No.	Approvals
0.3A	2CU03	UL SF A
0.5A	2CU05	UL SF A
0.75A	2CU075	UL SF A
0.8A	NA	
1.0A	2CU1	UL SF A
1.6A	2CU1.6	UL SF A
2.0A	2CU2	UL SF A
2.5A	2CU2.5	UL SF A
3.0A	2CU3	UL SF A
3.5A	2CU3.5	UL SF A
4.0A	2CU4	UL SF A
5.0A	2CU5	UL SF A
6.0A	2CU6	UL SF A
8.0A	2CU8	UL SF A
10A	2CU10	UL SF A
12A	NA	
12.5A	NA	
13A	2CU13	UL SF A
15A	2CU15	UL SF
16A	2CU16	UL SF A
20A	2CU20	UL SF A
25A	2CU25	UL SF A
30A	2CU30	UL SF
32A	2CU32	UL SF
40A	2CU40	UL SF
50A	2CU50	UL SF
60A	2CU60	UL SF
63A	2CU63	



Three Pole

Standard Pack: 4

Weight:

0.3A - 63A

1.68kg (3.7 lb.)

Rated Current	Type/ Cat. No.	Approvals
0.3A	3CU03	UL SF A
0.5A	3CU05	UL SF A
0.75A	3CU075	UL SF A
0.8A	NA	
1.0A	3CU1	UL SF A
1.6A	3CU1.6	UL SF A
2.0A	3CU2	UL SF A
2.5A	3CU2.5	UL SF A
3.0A	3CU3	UL SF A
3.5A	3CU3.5	UL SF A
4.0A	3CU4	UL SF A
5.0A	3CU5	UL SF A
6.0A	3CU6	UL SF A
8.0A	3CU8	UL SF A
10A	3CU10	UL SF A
12A	NA	
12.5A	NA	
13A	3CU13	UL SF A
15A	3CU15	UL SF
16A	3CU16	UL SF A
20A	3CU20	UL SF A
25A	3CU25	UL SF A
30A	3CU30	UL SF
32A	3CU32	UL SF
40A	3CU40	UL SF
50A	3CU50	UL SF
60A	3CU60	UL SF
63A	3CU63	



For ring tongue terminal version, replace "U" with "R" in part number. For example **1BR20** instead of **1BU20**.

D-Trip Characteristic



UL508 Listed
E137938



Application Examples:

High inrush motors, transformers, power supplies, heaters and reactive loads.
Relatively long thermal trip delay and very high magnetic trip point.



One Pole

Standard Pack: 12

Weight:

0.3A - 32A

1.68kg (3.7 lb.)

40A - 63A

1.92kg (4.23 lb.)

Rated Current	Type/ Cat. No.	Approvals
0.3A	1DU03	UL SP
0.5A	1DU05	UL SP
0.75A	1DU075	UL SP
0.8A	NA	
1.0A	1DU1	UL SP
1.6A	1DU1.6	UL SP
2.0A	1DU2	UL SP
2.5A	1DU2.5	UL SP
3.0A	1DU3	UL SP
3.5A	1DU3.5	UL SP
4.0A	1DU4	UL SP
5.0A	1DU5	UL SP
6.0A	1DU6	UL SP
8.0A	1DU8	UL SP
10A	1DU10	UL SP
12A	NA	
12.5A	NA	
13A	1DU13	UL SP
15A	1DU15	UL SP
16A	1DU16	UL SP
20A	1DU20	UL SP
25A	1DU25	UL SP
30A	1DU30	UL SP
32A	1DU32	UL SP
40A	1DU40	UL SP
50A	1DU50	UL SP
60A	1DU60	UL SP
63A	1DU63	UL SP



One Pole plus neutral

Standard Pack: 6

Weight:

0.3A - 32A

1.56kg (3.44 lb.)

40A - 63A

1.74kg (3.84 lb.)

Rated Current	Type/ Cat. No.	Approvals
0.3A	2DNU03	UL SP
0.5A	2DNU05	UL SP
0.75A	2DNU075	UL SP
0.8A	NA	
1.0A	2DNU1	UL SP
1.6A	2DNU1.6	UL SP
2.0A	2DNU2	UL SP
2.5A	2DNU2.5	UL SP
3.0A	2DNU3	UL SP
3.5A	2DNU3.5	UL SP
4.0A	2DNU4	UL SP
5.0A	2DNU5	UL SP
6.0A	2DNU6	UL SP
8.0A	2DNU8	UL SP
10A	2DNU10	UL SP
12A	NA	
12.5A	NA	
13A	2DNU13	UL SP
15A	2DNU15	UL SP
16A	2DNU16	UL SP
20A	2DNU20	UL SP
25A	2DNU25	UL SP
30A	2DNU30	UL SP
32A	2DNU32	UL SP
40A	2DNU40	UL SP
50A	2DNU50	UL SP
60A	2DNU60	UL SP
63A	2DNU63	UL SP



Two Pole

Standard Pack: 6

Weight:

0.3A - 63A

1.68kg (3.7 lb.)

Rated Current	Type/ Cat. No.	Approvals
0.3A	2DU03	UL SP
0.5A	2DU05	UL SP
0.75A	2DU075	UL SP
0.8A	NA	
1.0A	2DU1	UL SP
1.6A	2DU1.6	UL SP
2.0A	2DU2	UL SP
2.5A	2DU2.5	UL SP
3.0A	2DU3	UL SP
3.5A	2DU3.5	UL SP
4.0A	2DU4	UL SP
5.0A	2DU5	UL SP
6.0A	2DU6	UL SP
8.0A	2DU8	UL SP
10A	2DU10	UL SP
12A	NA	
12.5A	NA	
13A	2DU13	UL SP
15A	2DU15	UL SP
16A	2DU16	UL SP
20A	2DU20	UL SP
25A	2DU25	UL SP
30A	2DU30	UL SP
32A	2DU32	UL SP
40A	2DU40	UL SP
50A	2DU50	UL SP
60A	2DU60	UL SP
63A	2DU63	UL SP



Three Pole

Standard Pack: 4

Weight:

0.3A - 63A

1.68kg (3.7 lb.)

Rated Current	Type/ Cat. No.	Approvals
0.3A	3DU03	UL SP
0.5A	3DU05	UL SP
0.75A	3DU075	UL SP
0.8A	NA	
1.0A	3DU1	UL SP
1.6A	3DU1.6	UL SP
2.0A	3DU2	UL SP
2.5A	3DU2.5	UL SP
3.0A	3DU3	UL SP
3.5A	3DU3.5	UL SP
4.0A	3DU4	UL SP
5.0A	3DU5	UL SP
6.0A	3DU6	UL SP
8.0A	3DU8	UL SP
10A	3DU10	UL SP
12A	NA	
12.5A	NA	
13A	3DU13	UL SP
15A	3DU15	UL SP
16A	3DU16	UL SP
20A	3DU20	UL SP
25A	3DU25	UL SP
30A	3DU30	UL SP
32A	3DU32	UL SP
40A	3DU40	UL SP
50A	3DU50	UL SP
60A	3DU60	UL SP
63A	3DU63	UL SP



For ring tongue terminal version, replace "U" with "R" in part number. For example 1R20 instead of 1U20.

E-Trip Characteristic



UL508 Listed
E137938

Application Examples:

High efficiency motors, which have exceedingly high inrush currents. Relatively short thermal trip delays and very high magnetic trip points.



One Pole

Standard Pack: 12

Weight:

- 0.3A - 32A
1.68kg (3.7 lb.)
- 40A - 63A
1.92kg (4.23 lb.)

Rated Current	Type/ Cat. No.	Approvals
0.3A	1EU03	UL SFA
0.5A	1EU05	UL SFA
0.75A	1EU075	UL SFA
0.8A	NA	
1.0A	1EU1	UL SFA
1.6A	1EU1.6	UL SFA
2.0A	1EU2	UL SFA
2.5A	1EU2.5	UL SFA
3.0A	1EU3	UL SFA
3.5A	1EU3.5	UL SFA
4.0A	1EU4	UL SFA
5.0A	1EU5	UL SFA
6.0A	1EU6	UL SFA
8.0A	1EU8	UL SFA
10A	1EU10	UL SFA
12A	1EU12	UL SFA
12.5A	1EU125	UL SFA
13A	1EU13	UL SFA
15A	1EU15	UL SFA
16A	1EU16	UL SFA
20A	1EU20	UL SFA
25A	1EU25	UL SFA
30A	1EU30	UL SFA
32A	1EU32	UL SFA
40A	1EU40	UL SFA
50A	1EU50	UL SFA
60A	1EU60	UL SFA
63A	1EU63	UL SFA



One Pole plus neutral

Standard Pack: 6

Weight:

- 0.3A - 32A
1.56kg (3.44 lb.)
- 40A - 63A
1.74kg (3.84 lb.)

Rated Current	Type/ Cat. No.	Approvals
0.3A	2ENU03	UL SFA
0.5A	2ENU05	UL SFA
0.75A	2ENU075	UL SFA
0.8A	NA	
1.0A	2ENU1	UL SFA
1.6A	2ENU1.6	UL SFA
2.0A	2ENU2	UL SFA
2.5A	2ENU2.5	UL SFA
3.0A	2ENU3	UL SFA
3.5A	2ENU3.5	UL SFA
4.0A	2ENU4	UL SFA
5.0A	2ENU5	UL SFA
6.0A	2ENU6	UL SFA
8.0A	2ENU8	UL SFA
10A	2ENU10	UL SFA
12A	2ENU12	UL SFA
12.5A	2ENU125	UL SFA
13A	2ENU13	UL SFA
15A	2ENU15	UL SFA
16A	2ENU16	UL SFA
20A	2ENU20	UL SFA
25A	2ENU25	UL SFA
30A	2ENU30	UL SFA
32A	2ENU32	UL SFA
40A	2ENU40	UL SFA
50A	2ENU50	UL SFA
60A	2ENU60	UL SFA
63A	2ENU63	UL SFA



Two Pole

Standard Pack: 6

Weight:

- 0.3A - 63A
1.68kg (3.7 lb.)

Rated Current	Type/ Cat. No.	Approvals
0.3A	2EU03	UL SFA
0.5A	2EU05	UL SFA
0.75A	2EU075	UL SFA
0.8A	NA	
1.0A	2EU1	UL SFA
1.6A	2EU1.6	UL SFA
2.0A	2EU2	UL SFA
2.5A	2EU2.5	UL SFA
3.0A	2EU3	UL SFA
3.5A	2EU3.5	UL SFA
4.0A	2EU4	UL SFA
5.0A	2EU5	UL SFA
6.0A	2EU6	UL SFA
8.0A	2EU8	UL SFA
10A	2EU10	UL SFA
12A	2EU12	UL SFA
12.5A	2EU125	UL SFA
13A	2EU13	UL SFA
15A	2EU15	UL SFA
16A	2EU16	UL SFA
20A	2EU20	UL SFA
25A	2EU25	UL SFA
30A	2EU30	UL SFA
32A	2EU32	UL SFA
40A	2EU40	UL SFA
50A	2EU50	UL SFA
60A	2EU60	UL SFA
63A	2EU63	UL SFA



Three Pole

Standard Pack: 4

Weight:

- 0.3A - 63A
1.68kg (3.7 lb.)

Rated Current	Type/ Cat. No.	Approvals
0.3A	3EU03	UL SFA
0.5A	3EU05	UL SFA
0.75A	3EU075	UL SFA
0.8A	NA	
1.0A	3EU1	UL SFA
1.6A	3EU1.6	UL SFA
2.0A	3EU2	UL SFA
2.5A	3EU2.5	UL SFA
3.0A	3EU3	UL SFA
3.5A	3EU3.5	UL SFA
4.0A	3EU4	UL SFA
5.0A	3EU5	UL SFA
6.0A	3EU6	UL SFA
8.0A	3EU8	UL SFA
10A	3EU10	UL SFA
12A	3EU12	UL SFA
12.5A	3EU125	UL SFA
13A	3EU13	UL SFA
15A	3EU15	UL SFA
16A	3EU16	UL SFA
20A	3EU20	UL SFA
25A	3EU25	UL SFA
30A	3EU30	UL SFA
32A	3EU32	UL SFA
40A	3EU40	UL SFA
50A	3EU50	UL SFA
60A	3EU60	UL SFA
63A	3EU63	UL SFA



For ring tongue terminal version, replace "U" with "R" in part number. For example **1R20** instead of **1U20**.

G-Trip Characteristic



UL508 Listed
E137938

Application Examples:

General industrial, including motors, some transformers, solenoids, control circuits, lighting and wiring. Meets the US trip norms with relatively short thermal trip delay and high magnetic trip point.



One Pole

Standard Pack: 12

Weight:

0.3A - 32A
1.68kg (3.7 lb.)
40A - 63A
1.92kg (4.23 lb.)

Rated Current	Type/ Cat. No.	Approvals
0.3A	1GU03	UL SP
0.5A	1GU05	UL SP
0.75A	NA	
0.8A	1GU08	UL SP
1.0A	1GU1	UL SP
1.6A	1GU1.6	UL SP
2.0A	1GU2	UL SP
2.5A	1GU2.5	UL SP
3.0A	1GU3	UL SP
3.5A	1GU3.5	UL SP
4.0A	1GU4	UL SP
5.0A	1GU5	UL SP
6.0A	1GU6	UL SP
8.0A	1GU8	UL SP
10A	1GU10	UL SP
12A	1GU12	UL SP
12.5A	1GU125	UL SP
13A	1GU13	UL SP
15A	1GU15	UL SP
16A	1GU16	UL SP
20A	1GU20	UL SP
25A	1GU25	UL SP
30A	1GU30	UL SP
32A	1GU32	UL SP
40A	1GU40	UL SP
50A	1GU50	UL SP
60A	1GU60	UL SP
63A	1GU63	UL SP



One Pole plus neutral

Standard Pack: 6

Weight:

0.3A - 32A
1.56kg (3.44 lb.)
40A - 63A
1.74kg (3.84 lb.)

Rated Current	Type/ Cat. No.	Approvals
0.3A	2GNU03	UL SP
0.5A	2GNU05	UL SP
0.75A	NA	
0.8A	2GNU08	UL SP
1.0A	2GNU1	UL SP
1.6A	2GNU1.6	UL SP
2.0A	2GNU2	UL SP
2.5A	2GNU2.5	UL SP
3.0A	2GNU3	UL SP
3.5A	2GNU3.5	UL SP
4.0A	2GNU4	UL SP
5.0A	2GNU5	UL SP
6.0A	2GNU6	UL SP
8.0A	2GNU8	UL SP
10A	2GNU10	UL SP
12A	2GNU12	UL SP
12.5A	2GNU125	UL SP
13A	2GNU13	UL SP
15A	2GNU15	UL SP
16A	2GNU16	UL SP
20A	2GNU20	UL SP
25A	2GNU25	UL SP
30A	2GNU30	UL SP
32A	2GNU32	UL SP
40A	2GNU40	UL SP
50A	2GNU50	UL SP
60A	2GNU60	UL SP
63A	2GNU63	UL SP



Two Pole

Standard Pack: 6

Weight:

0.3A - 63A
1.68kg (3.7 lb.)

Rated Current	Type/ Cat. No.	Approvals
0.3A	2GU03	UL SP
0.5A	2GU05	UL SP
0.75A	NA	
0.8A	2GU08	UL SP
1.0A	2GU1	UL SP
1.6A	2GU1.6	UL SP
2.0A	2GU2	UL SP
2.5A	2GU2.5	UL SP
3.0A	2GU3	UL SP
3.5A	2GU3.5	UL SP
4.0A	2GU4	UL SP
5.0A	2GU5	UL SP
6.0A	2GU6	UL SP
8.0A	2GU8	UL SP
10A	2GU10	UL SP
12A	2GU12	UL SP
12.5A	2GU125	UL SP
13A	2GU13	UL SP
15A	2GU15	UL SP
16A	2GU16	UL SP
20A	2GU20	UL SP
25A	2GU25	UL SP
30A	2GU30	UL SP
32A	2GU32	UL SP
40A	2GU40	UL SP
50A	2GU50	UL SP
60A	2GU60	UL SP
63A	2GU63	UL SP



Three Pole

Standard Pack: 4

Weight:

0.3A - 63A
1.68kg (3.7 lb.)

Rated Current	Type/ Cat. No.	Approvals
0.3A	3GU03	UL SP
0.5A	3GU05	UL SP
0.75A	NA	
0.8A	3GU08	UL SP
1.0A	3GU1	UL SP
1.6A	3GU1.6	UL SP
2.0A	3GU2	UL SP
2.5A	3GU2.5	UL SP
3.0A	3GU3	UL SP
3.5A	3GU3.5	UL SP
4.0A	3GU4	UL SP
5.0A	3GU5	UL SP
6.0A	3GU6	UL SP
8.0A	3GU8	UL SP
10A	3GU10	UL SP
12A	3GU12	UL SP
12.5A	3GU125	UL SP
13A	3GU13	UL SP
15A	3GU15	UL SP
16A	3GU16	UL SP
20A	3GU20	UL SP
25A	3GU25	UL SP
30A	3GU30	UL SP
32A	3GU32	UL SP
40A	3GU40	UL SP
50A	3GU50	UL SP
60A	3GU60	UL SP
63A	3GU63	UL SP



For ring tongue terminal version, replace "U" with "R" in part number. For example **1BR20** instead of **1BU20**.

Z-Trip Characteristic



UL508 Listed
E137938

Application Examples:

Semiconductors, components which fail-short (vs. fail-open), and components/devices with low surge-current and short circuit withstand capabilities. Relatively short thermal delay and very low magnetic trip point.



One Pole

Standard Pack: 12

Weight:
0.3A - 32A
1.68kg (3.7 lb.)
40A - 63A
1.92kg (4.23 lb.)

Rated Current	Type/ Cat. No.	Approvals
0.3A	1ZU03	UL SF
0.5A	1ZU05	UL SF
0.75A	1ZU075	UL SF
0.8A	NA	
1.0A	1ZU1	UL SF
1.6A	1ZU1.6	UL SF
2.0A	1ZU2	UL SF
2.5A	1ZU2.5	UL SF
3.0A	1ZU3	UL SF
3.5A	1ZU3.5	UL SF
4.0A	1ZU4	UL SF
5.0A	1ZU5	UL SF
6.0A	1ZU6	UL SF
8.0A	1ZU8	UL SF
10A	1ZU10	UL SF
12A	1ZU12	UL SF
12.5A	1ZU125	UL SF
13A	1ZU13	UL SF
15A	1ZU15	UL SF
16A	1ZU16	UL SF
20A	1ZU20	UL SF
25A	1ZU25	UL SF
30A	1ZU30	UL SF
32A	1ZU32	UL SF
40A	1ZU40	UL SF *
50A	1ZU50	UL SF *



One Pole plus neutral

Standard Pack: 6

Weight:
0.3A - 32A
1.56kg (3.44 lb.)
40A - 63A
1.74kg (3.84 lb.)

Rated Current	Type/ Cat. No.	Approvals
0.3A	2ZNU03	UL SF
0.5A	2ZNU05	UL SF
0.75A	2ZNU075	UL SF
0.8A	NA	
1.0A	2ZNU1	UL SF
1.6A	2ZNU1.6	UL SF
2.0A	2ZNU2	UL SF
2.5A	2ZNU2.5	UL SF
3.0A	2ZNU3	UL SF
3.5A	2ZNU3.5	UL SF
4.0A	2ZNU4	UL SF
5.0A	2ZNU5	UL SF
6.0A	2ZNU6	UL SF
8.0A	2ZNU8	UL SF
10A	2ZNU10	UL SF
12A	2ZNU12	UL SF
12.5A	2ZNU125	UL SF
13A	2ZNU13	UL SF
15A	2ZNU15	UL SF
16A	2ZNU16	UL SF
20A	2ZNU20	UL SF
25A	2ZNU25	UL SF
30A	2ZNU30	UL SF
32A	2ZNU32	UL SF
40A	2ZNU40	UL SF *
50A	2ZNU50	UL SF *



Two Pole

Standard Pack: 6

Weight:
0.3A - 63A
1.68kg (3.7 lb.)

Rated Current	Type/ Cat. No.	Approvals
0.3A	2ZU03	UL SF
0.5A	2ZU05	UL SF
0.75A	2ZU075	UL SF
0.8A	NA	
1.0A	2ZU1	UL SF
1.6A	2ZU1.6	UL SF
2.0A	2ZU2	UL SF
2.5A	2ZU2.5	UL SF
3.0A	2ZU3	UL SF
3.5A	2ZU3.5	UL SF
4.0A	2ZU4	UL SF
5.0A	2ZU5	UL SF
6.0A	2ZU6	UL SF
8.0A	2ZU8	UL SF
10A	2ZU10	UL SF
12A	2ZU12	UL SF
12.5A	2ZU125	UL SF
13A	2ZU13	UL SF
15A	2ZU15	UL SF
16A	2ZU16	UL SF
20A	2ZU20	UL SF
25A	2ZU25	UL SF
30A	2ZU30	UL SF
32A	2ZU32	UL SF
40A	2ZU40	UL SF *
50A	2ZU50	UL SF *



Three Pole

Standard Pack: 4

Weight:
0.3A - 63A
1.68kg (3.7 lb.)

Rated Current	Type/ Cat. No.	Approvals
0.3A	3ZU03	UL SF
0.5A	3ZU05	UL SF
0.75A	3ZU075	UL SF
0.8A	NA	
1.0A	3ZU1	UL SF
1.6A	3ZU1.6	UL SF
2.0A	3ZU2	UL SF
2.5A	3ZU2.5	UL SF
3.0A	3ZU3	UL SF
3.5A	3ZU3.5	UL SF
4.0A	3ZU4	UL SF
5.0A	3ZU5	UL SF
6.0A	3ZU6	UL SF
8.0A	3ZU8	UL SF
10A	3ZU10	UL SF
12A	3ZU12	UL SF
12.5A	3ZU125	UL SF
13A	3ZU13	UL SF
15A	3ZU15	UL SF
16A	3ZU16	UL SF
20A	3ZU20	UL SF
25A	3ZU25	UL SF
30A	3ZU30	UL SF
32A	3ZU32	UL SF
40A	3ZU40	UL SF *
50A	3ZU50	UL SF *



For ring tongue terminal version, replace "U" with "R" in part number. For example **1BR20** instead of **1BU20**.

V-EA Trip Curves

B Trip Curve

V-EA-B Trip
1.0A Through 10A Rated Current

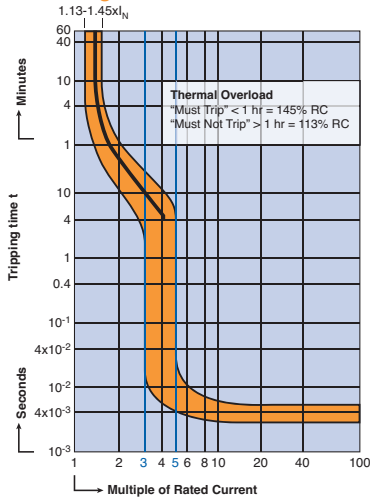

C Trip Curve

V-EA-C Trip
0.3A Through 10A Rated Current

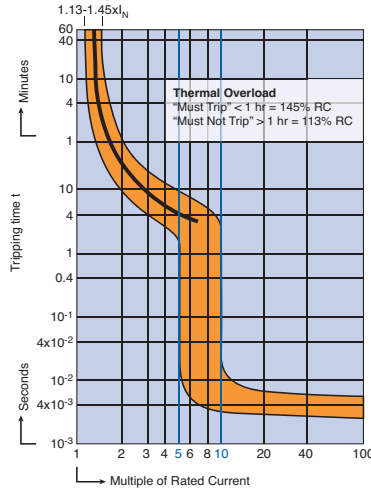

D Trip Curve

V-EA-D Trip
0.3A Through 10A Rated Current

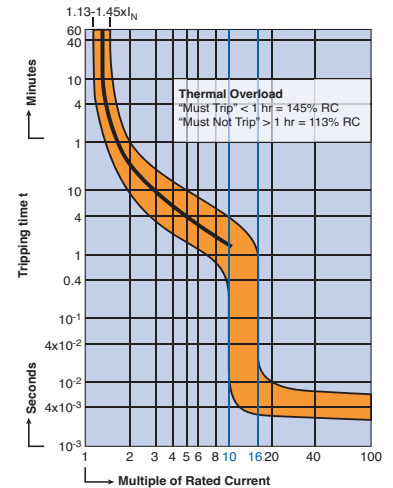

V-EA-B Trip
13A Through 63A Rated Current

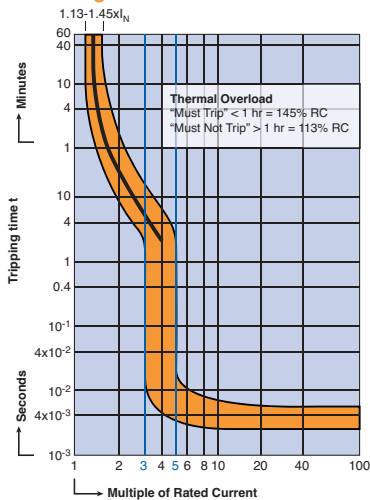

V-EA-C Trip
13A Through 63A Rated Current

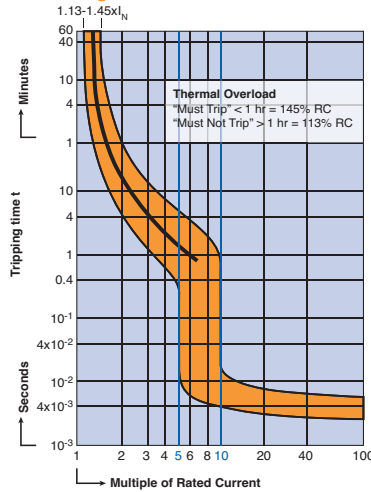

V-EA-D Trip
13A Through 63A Rated Current

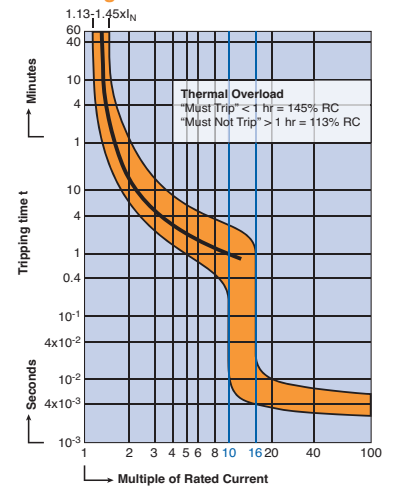

“B” Magnetic Trip Parameters

Rated current 1.0A to 63A.

1. Hold for a minimum of 100ms at surge of 3 times rated current.
2. Trip in under 100ms at 5 times rated current.

“C” Magnetic Trip Parameters

Rated current 0.3A to 63A.

1. Hold for a minimum of 100ms at surge of 5 times rated current.
2. Trip in under 100ms at 10 times rated current.

“D” Magnetic Trip Parameters

Rated current 0.3A to 63A.

1. Hold for a minimum of 100ms at surge of 10 times rated current.
2. Trip in under 100ms at 16 times rated current.

V-EA Trip Curves

E Trip Curve

V-EA-E Trip
0.3A Through 10A Rated Current

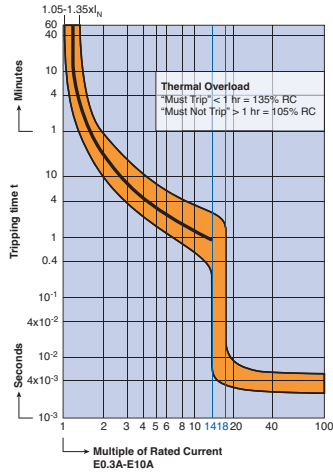

V-EA-E Trip
12A Through 60A Rated Current

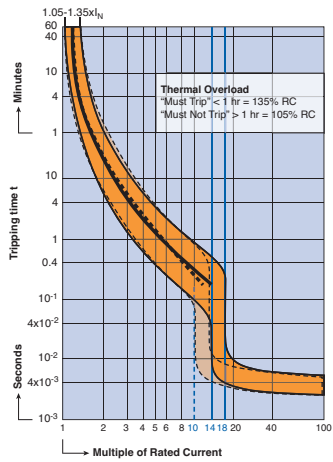

“E” Magnetic Trip Parameters
Rated Current, 0.3A to 50A (——),
60/63A (- - - -).

Magnetic Trip:

1. Hold for a minimum of 100ms at surge of 14 times (60A, 10 times) rated current.
2. Trip in under 100ms at 18 times (60A, 14 times) rated current.

G Trip Curve

V-EA-G Trip
0.3A Through 10A Rated Current

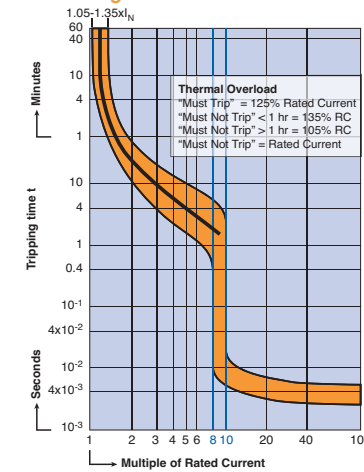

V-EA-G Trip
12A Through 63A Rated Current

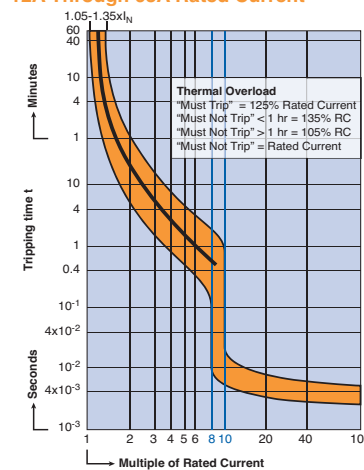

“G” Magnetic Trip Parameters
Rated Current, 0.3A to 63A.

Magnetic Trip:

1. Hold for a minimum of 100ms at surge of 8 times rated current.
2. Trip in under 100ms at 10 times rated current.

Z Trip Curve

V-EA-Z Trip
0.3A Through 10A Rated Current

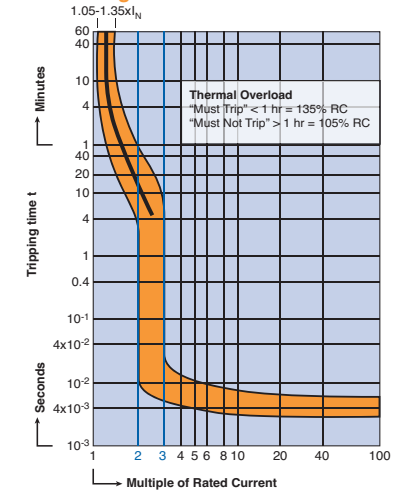

V-EA-Z Trip
12.5A Through 32A Rated Current

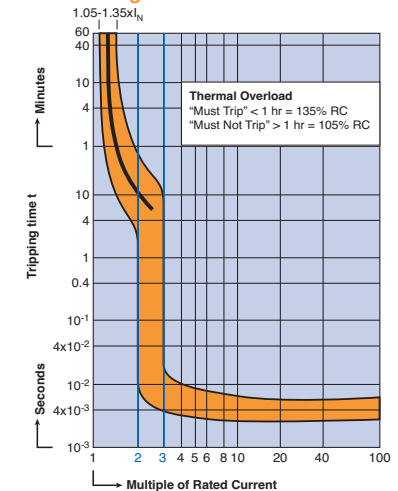

“Z” Trip Parameters
Rated Current, 0.3A to 32A.

Magnetic Trip:

1. Hold for a minimum of 100ms at 2 times rated current.
2. Trip in under 100ms at 3 times rated current.

Table HP 1: AMPERE RATINGS & HORSEPOWER RATING 1 PHASE

			FLA & LRC CONVERTED TO TABLE HORSEPOWER (SEE NOTE #2) USE FLA & LRC RATINGS WHERE NO HP RATING IS GIVEN					
			NOMINAL CIRCUIT VOLTAGE					
V-EA RATED	MOTOR NAMEPLATE	MOTOR NAMEPLATE	110-120 VAC	200 VAC	208 VAC	220-240 VAC	265 VAC	277 VAC
CURRENT (SEE NOTE #1)	FLA RATING	STARTING/ LRC RATING						
0.30A 0.50A 0.75A	0.30A 0.50A 0.75A	1.80A 3.00A 4.35A						
0.80A 1.0A 1.6A	0.80A 1.0A 1.6A	4.8A 6.0A 9.6A						
2.0A 2.5A 3.0A	2.0A 2.5A 3.0A	12.0A 15.0A 18.0A		1/6hp 1/6hp	1/6hp 1/6hp	1/6hp 1/6hp 1/4hp	1/6hp 1/6hp 1/4hp	1/6hp 1/4hp 1/3hp
3.5A 4.0A	3.5A 4.0A	21.0A 24.0A		1/4hp 1/4hp	1/4hp 1/3hp	1/4hp 1/3hp	1/3hp 1/3hp	1/3hp 1/3hp
5.0A 6.0A 8.0A	5.0A 6.0A 8.0A	30.0A 36.0A 48.0A	1/6hp 1/4hp 1/3hp	1/3hp 1/2hp 3/4hp	1/2hp 1/2hp 3/4hp	1/2hp 1/2hp 1hp	1/2hp 3/4hp 1hp	1/2hp 3/4hp 1hp
10.0A	10.0A	60.0A	1/2hp	1hp	1hp	1 1/2hp	1 1/2hp	2hp
12.0A 12.5A	12.0A 12.5A	72.0A 75.0A	1/2hp 1/2hp	1 1/2hp 1 1/2hp	1 1/2hp 1 1/2hp	2hp	2hp	2hp 2hp
13.0A 15.0A 16.0A	13.0A 15.0A 16.0A	78.0A 90.0A 96.0A	1/2hp 3/4hp 1hp	1 1/2hp 2hp 2hp	1 1/2hp 2hp 2hp	2hp 2hp 2hp	2hp 3hp 3hp	2hp 3hp 3hp
20.0A 25.0A	20.0A 25.0A	120.0A 150.0A	1 1/2hp 2hp	3hp 3hp	3hp 3hp	3hp 3hp	3hp 5hp	3hp 5hp
30.0A	30.0A	180.0A	2hp	3hp	3hp	5hp	5hp	5hp
32.0A	32.0A	192.0A	2hp	3hp	5hp	5hp	5hp	5hp
40.0A	40.0A	240.0A	3hp	5hp	7 1/2hp	7 1/2hp	7 1/2hp	7 1/2hp
50.0A 60.0A	50.0A 60.0A	300.0A 360.0A	3hp 5hp	7 1/2hp 10hp	10hp 10hp	10hp 10hp	10hp 10hp	10hp 15hp

NOTE #1: For AC motor circuit nameplate full load current, AC general-use loads, AC resistance loads, AC incandescent lamp (tungsten) loads, AC electric discharge lamp (ballast) loads.
NOTE #2: Conversions per UL508® Table 45.2 and NFPA-70: National Electrical Code® 2008 Tables 430-248 and 430-251(A).

Table HP 2: AMPERE RATING & HORSEPOWER RATING 3 PHASE & 2 PHASE - 4 WIRE

FLA & LRC RATINGS CONVERTED TO TABLE HORSEPOWER (SEE NOTE #2) USE FLA & LRC RATINGS WHERE NO HP IS LISTED													
V-EA RATED CURRENT (SEE NOTE #1)	MOTOR NAMEPLATE FLA RATING	MOTOR NAMEPLATE STARTING/ LRC RATING	110-120 VAC		200 VAC		208 VAC		220-240 VAC (SEE NOTE #3)		440-480 VAC		
			Motor Design		Motor Design		Motor Design		Motor Design		Motor Design		
			B, C, D	E	B, C, D	E	B, C, D	E	B, C, D	E	B, C, D	E	
0.30A 0.50A 0.75A	0.30A 0.50A 0.75A	3.0A 5.0A 7.5A											
0.80A 1.0A 1.6A	0.80A 1.0A 1.6A	8.0A 10.0A 16.0A										1/2hp	1/2hp
2.0A 2.5A 3.0A	2.0A 2.5A 3.0A	20.0A 25.0A 30.0A			1/2hp 1/2hp	1/2hp 1/2hp	1/2hp 1/2hp	1/2hp 1/2hp	1/2hp 1/2hp	1/2hp 1/2hp	3/4hp 1hp 1 1/2hp	3/4hp 1hp 1 1/2hp	3/4hp 1hp 1 1/2hp
3.5A 4.0A	3.5A 4.0A	35.0A 40.0A			1/2hp 3/4hp	1/2hp 3/4hp	3/4hp 3/4hp	3/4hp 3/4hp	3/4hp 3/4hp	3/4hp 3/4hp	2hp 2hp	2hp 2hp	2hp 2hp
5.0A 6.0A 8.0A	5.0A 6.0A 8.0A	42.0A 50.4A 67.2A	1/2hp 1/2hp 3/4hp	1/2hp 1/2hp 3/4hp	1hp 1hp 2hp	1hp 1hp 2hp	1hp 1hp 2hp	1hp 1hp 2hp	1hp 1 1/2hp 2hp	1hp 1 1/2hp 2hp	3hp 3hp 5hp	3hp 3hp 5hp	3hp 3hp 5hp
10.0A 12.0A 12.5A	10.0A 12.0A 12.5A	84.0A 100.8A 105.0A	1hp 1 1/2hp 1 1/2hp	1hp 1 1/2hp 1 1/2hp	2hp 3hp 3hp	2hp 3hp 3hp	2hp 3hp 3hp	2hp 3hp 3hp	3hp 3hp 3hp	3hp 3hp 3hp	5hp 7 1/2hp 7 1/2hp	5hp 7 1/2hp 7 1/2hp	5hp 7 1/2hp 7 1/2hp
13.0A 15.0A 16.0A	13.0A 15.0A 16.0A	109.2A 126.0A 134.4A	1 1/2hp 2hp 2hp	1 1/2hp 2hp 2hp	3hp 3hp 3hp	3hp 3hp 3hp	3hp 3hp 3hp	3hp 3hp 3hp	3hp 3hp 5hp	3hp 3hp 5hp	7 1/2hp 10hp 10hp	7 1/2hp 10hp 10hp	7 1/2hp 10hp 10hp
20.0A 25.0A	20.0A 25.0A	168.0A 210.0A	3hp 3hp	3hp 3hp	5hp 5hp	5hp 5hp	5hp 7 1/2hp	5hp 7 1/2hp	5hp 7 1/2hp	5hp 7 1/2hp	10hp 15hp	10hp 15hp	10hp 15hp
30.0A	30.0A	252.0A	5hp	5hp	5hp	5hp	7 1/2hp	7 1/2hp	10hp	10hp	20hp	20hp	20hp
32.0A	32.0A	268.8A	5hp	5hp	5hp	5hp	10hp	10hp	10hp	10hp	20hp	20hp	20hp
40.0A	40.0A	226.0A	5hp	5hp	10hp	7 1/2hp	10hp	7 1/2hp	10hp	10hp	30hp	20hp	20hp
50.0A 60.0A	50.0A 60.0A	282.5A 339.0A	7 1/2hp 10hp	7 1/2hp 10hp	15hp 15hp	10hp 10hp	15hp 20hp	10hp 10hp	15hp 20hp	10hp 15hp	30hp 40hp	25hp 30hp	25hp 30hp

NOTE #1: For AC motor circuit nameplate full load current, AC general-use loads, AC resistance loads, AC incandescent lamp (tungsten) loads, AC electric discharge lamp (ballast) loads.
NOTE #2: Conversions per UL508® proposed Tables 45.2 and 45.4 and NFPA-70: National Electrical Code® 2008 Tables 430-249, 430-250 and 430-251(B).

V-EA INTERNAL RESISTANCE

Rated Current (Amp)	Trip Characteristic					
	B (Ohms)	C (Ohms)	D (Ohms)	E (Ohms)	G (Ohms)	Z (Ohms)
0.3	—	16.8620	16.8620	14.52000	16.8620	31.5060
0.5	—	6.8540	6.0009	5.92000	6.8540	10.2460
0.75/0.8	—	3.0540	3.0540	2.70000	3.0540	5.3920
1.0	—	1.7000	1.7560	1.48000	1.7560	2.6910
1.6	—	0.5870	0.5870	0.57400	0.5870	0.9440
2.0	—	0.4190	0.4190	0.40500	0.4190	0.8900
2.5	—	0.2950	0.2950	0.26900	0.2950	0.4290
3.0	—	0.2020	0.2020	0.18600	0.2020	0.3460
3.5	—	0.1390	0.1390	0.13900	0.1390	0.1790
4.0	—	0.1090	0.1090	0.10600	0.1090	0.1620
5.0	—	0.0654	0.0654	0.05900	0.0654	0.1050
6.0	0.0528	0.0528	0.0491	0.04600	0.0491	0.0823
8.0	—	0.0278	0.0240	0.03040	0.0333	0.0371
10	0.0216	0.0216	0.0187	0.02020	0.0211	0.0278
12/12.5	—	—	—	0.00724	0.0084	0.0151
13	0.0113	0.0084	0.0085	0.00724	0.0084	0.0151
15/16	0.0085	0.0085	0.0076	0.00731	0.0076	0.0114
20	0.0067	0.0067	0.0064	0.00582	0.0064	0.0075
25	0.0050	0.0050	0.0041	0.00411	0.0046	0.0050
30/32	0.0032	0.0032	0.0027	0.00272	0.0030	0.0032
40	0.0025	0.0025	0.0022	0.00212	0.0022	0.0022
50	0.0019	0.0019	0.0018	0.00184	0.0019	0.00195
60/63	0.0018	0.0018	0.0017	0.00172	0.00179	—

Resistances listed are “hot” values, as opposed to cold start values. Operating voltage drop across the V-EA and power loss per pole can be approximated with basic formulas:

$$V_{DROP} = I_{OPERATING} \times R_{TABLE}$$

$$P_{LOSS P/P} = I_{OPERATING}^2 \times R_{TABLE}$$

Voltage drops should be reviewed when V-EAs with high internal resistance are used (e.g., load voltage minimums). Power loss should be reviewed when V-EAs with high rated currents are used (e.g., enclosure heating).

The listed V-EA internal resistance values should not be used in calculations of available short-circuit current downstream of the V-EA. The dynamic impedance of the V-EA under short-circuit conditions can vary significantly from internal resistance values in normal operation.

LINE CURRENT FREQUENCY EFFECTS ON TRIP CURVES

Frequency Effects on Magnetic Trip Curves					
Trip Curve	Trip Zone At 16 2/3 - 60Hz (x RC)	Trip Zone At 100 Hz (x RC)	Trip Zone At 200 Hz (x RC)	Trip Zone At 400 Hz (x RC)	Trip Zone At DC (x RC)
Z	2 - 3	2.2 - 3.3	2.4 - 3.6	2.8 - 4.2	3.0 - 4.5
B	3 - 5	3.3 - 5.5	3.6 - 6.0	4.2 - 7.0	4.5 - 7.5
C	5 - 10	5.5 - 11.0	6.0 - 12	7.0 - 14.0	7.5 - 15.0
G	8 - 10	8.8 - 11.0	9.6 - 12.0	11.2 - 14.0	12.0 - 15.0
D	10 - 16	11.0 - 17.6	12.0 - 19.2	14.0 - 22.4	15.0 - 24.0
E	14 - 18	15.4 - 19.8	16.8 - 21.6	19.6 - 25.2	21.0 - 27.0

The thermal trip is not affected by the frequency of the line current. The magnetic trip is within the trip zone of the characteristic curve for frequencies from 16 2/3 to 60Hz. At lower and higher frequencies, the magnetic trip will be delayed longer than indicated by the characteristic curve, roughly as follows:

At 100Hz: Mag. Trip Current = 1.1 x curve current

At 200Hz: Mag. Trip Current = 1.2 x curve current

At 400Hz: Mag. Trip Current = 1.4 x curve current

At DC: Mag. Trip Current = 1.5 x curve current

For example, at 16 2/3 - 60 Hz the magnetic trip zone for the “G” characteristic is 8 to 10 times the rated current of the specific V-EA (i.e., hold for at least 100ms at 8 x RC, trip in less than 100ms at 10 x RC). With a 400Hz current, a magnetic trip at 10 x RC would be greatly delayed (thermal would likely trip first), as the magnetic trip zone is now 11.2 to 14 x RC. If a quicker magnetic trip is required with 400Hz, the “B” or “C” characteristic should be considered.

MECHANICAL ENDURANCE RATINGS (ON/OFF OPERATIONS)

Application	2 x (1.15 x RC)	2 x RC	RC	No Load	Total
AC General Use	—	6000	—	4000	10000
AC Motor Starting Across the Line	1000	—	5000	4000	10000
AC Incandescent Lamps (Tungsten)	—	—	6000	4000	10000
AC Electrical Discharge Lamps (Ballast)	—	6000	—	4000	10000
AC Resistance	—	6000	—	4000	10000
Manufacturers self certification	20000 ON/OFF operations with no load				

MA- Series

Three Phase Adjustable Trip Miniature Circuit Breakers/ Manual Motor Controllers

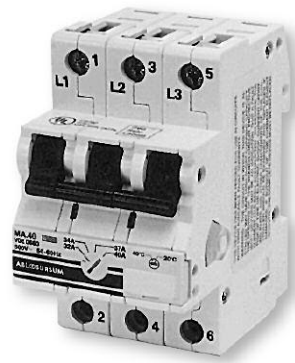

The MA was designed to handle the high inrush loads of 3 phase transformers, power supplies, motors, etc. The MA protects wiring and equipment from damage caused by the three major classes of over-current, yet greatly reduces the number of nuisance trips in high starting and inrush current circuits.

An IEC device with excellent ratings under a UL listing at 480Y/277V (including group ratings) and at 500V under international standards, the Altech/ABL Sursum MA provides short and long term cost effective circuit protection for USA and/or export applications. The short term advantages include: (1) adjustable thermal trip allows finalization of initial designs before procurement of the load equipment is complete; (2) snap-on mounting for readily available, internationally standardized DIN Rail saves panel layout design time as well as installation and change labor; (3) large cage-clamp terminals with screws suitable to power screwdrivers, simplifies and speeds wiring; (4) convenient switched disconnect during factory testing and/or initial start-up saves time and aggravation. The key long term advantage is customer satisfaction and proven over-current protection of wiring and equipment (and the lack of rework/repair costs).

Type Designation

MA RT
(a) **(b)** **(c)** **(d)**

- (a) = MA - Manual Motor Controller
- (b) = Rated Current
- (c) = U - US Housing
- (d) = Blank - Standard Terminal
- RT - Ring-tongue Terminal

Voltage Rating	480Y/277VAC
AIC (Interrupt Capacity)	0.16A-2.5A: 42kA; 4.0A-16A: 14kA; 20A-40A: 10kA
Standard Short Circuit Withstand Rating (UL/CSA Ratings)	0.16A-2.5A: 42kA; 4.0A-16A: 14kA
Group Short Circuit Ratings (UL/CSA Ratings)	see above
Typical Life	6000 on/off operations with 2xRC
Calibration Temperature	25°C, +0°, -5° (77°F, +0° -9°)
Standard Pack and Weight	1/450g (1.0 lb.)
Terminal Size Acceptability	Top/Bottom: 18-3 AWG

Type and Rated Current	Cat. No.	FLA Dial Adjustment Markings	GROUP SHORT CIRCUIT RATING AT 480VAC ^a (and BCP size)	3Ø HORSEPOWER RATINGS AT NOMINAL LINE VOLTAGE (See Note for HEA Definition)				
				110-120V HP (HEA)	200V HP (HEA)	208V HP (HEA)	220-240V HP (HEA)	460-480V HP (HEA)
MA0.16U	15.901U	0.1/ 0.12/0.14/0.16	42kARMS symmetrical (max. 1200A MCCB or RK5)					
MA0.25U	15.902U	0.16/0.19/0.22/0.25						
MA0.40U	15.903U	0.25/0.30/0.35/0.40						
MA0.63U	15.904U	0.40/0.48/0.56/0.63						
MA1.0U	15.905U	0.63/0.75/0.87/1.0						
MA1.6U	15.906U	1.0/1.2/1.4/1.6						
MA2.5U	15.907U	1.6/1.9/2.2/2.5	14kARMS symmetrical (max. 350A MCCB or RK5)					
MA4.0U	15.908U	2.5/3.0/3.5/4.0		1/2 (4.0)	3/4 (3.2)	3/4 (3.1)	1 (3.6)	2 (3.42)
MA6.3U	15.909U	4.0/4.8/5.6/6.3		3/4 (5.6)	1 1/2 (6.0)	1 1/2 (5.7)	1 1/2 (5.2)	3 (4.8)
MA10U	15.910U	6.3/7.5/8.7/10		1 (7.2)	2 (7.8)	2 (7.5)	3 (9.6)	5 (7.6)
MA16U	15.911U	10/12/14/16		2 (13.6)	3 (11.0)	3 (10.6)	5 (15.2)	10 (14.0)
MA20U	15.912U	16/17/18.5/20		3 (19.2)	5 (17.5)	5 (16.7)	5 (15.2)	10 (14.0)
MA25U	15.913U	20/21.5/23/25		3 (19.2)	5 (17.5)	7 1/2 (24.2)	7 1/2 (22.0)	15 (21.0)
MA32U	15.914U	25/27/30/32		5 (30.4)	7 1/2 (25.0)	7 1/2 (24.2)	10 (28.0)	20 (27.0)
MA40U	15.915U	32/34/37/40		5 (30.4)	10 (32.0)	10 (31.0)	10 (28.0)	25 (34.0)

Through MA2.5U, ampere rated for motor circuits having a full-load-amperage (FLA) not exceeding the MA's general purpose rated current (RC, equals maximum dial setting) and a locked rotor current not exceeding 6 times the MA's RC.

Note: **HEA - Horsepower Equivalent Amperes**, the nominal amperage assigned to standard motor horsepower ratings in design guide tables such as NFPA-70 Tables 430-248, 430-249, 430-250; UL1077 Table 16.2; CSA - C22.2 No. 235-M89 Tables 44 and 45; CSA-C22.2 No. 14-M91 Table 19, etc. Multiply HEA values (in parenthesis) by 1.1 if power factor is 90%, and by 1.2 if power factor is 80%.

^a The standard-circuit short-circuit rating is 14kA for all types. Group ratings can be used in a standard circuit (e.g., MA1.0U at 42kA), but a higher standard rating cannot be used in a group circuit (e.g., MA40U at 14kA only in standard circuit.)

DIMENSIONS

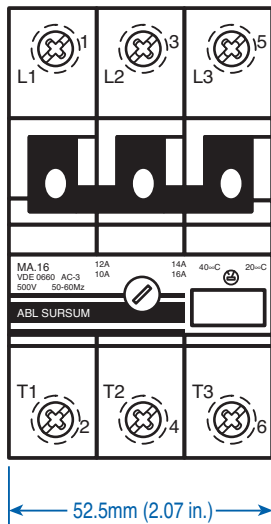
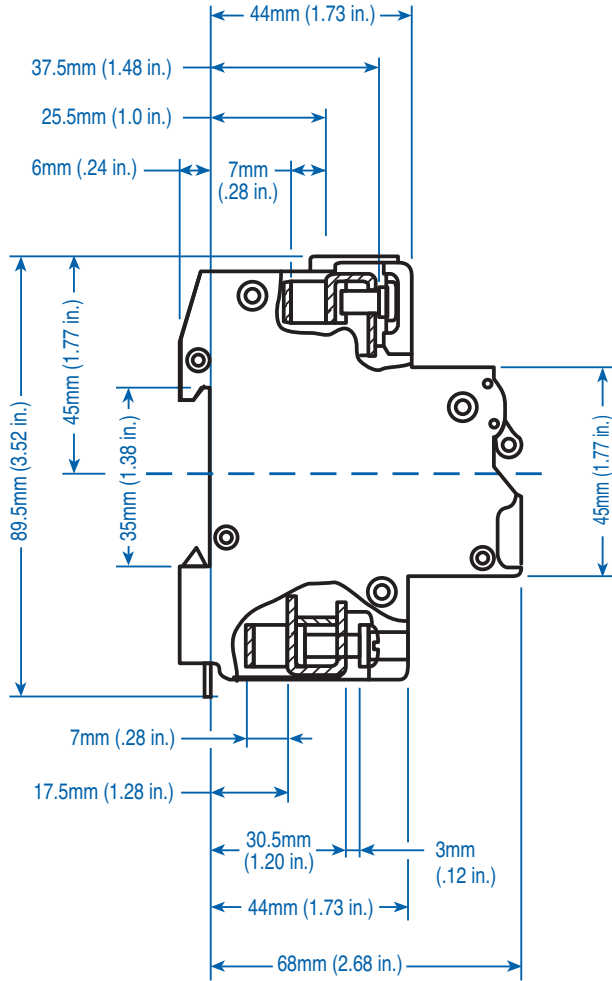

MA/USA Manual Motor Controller

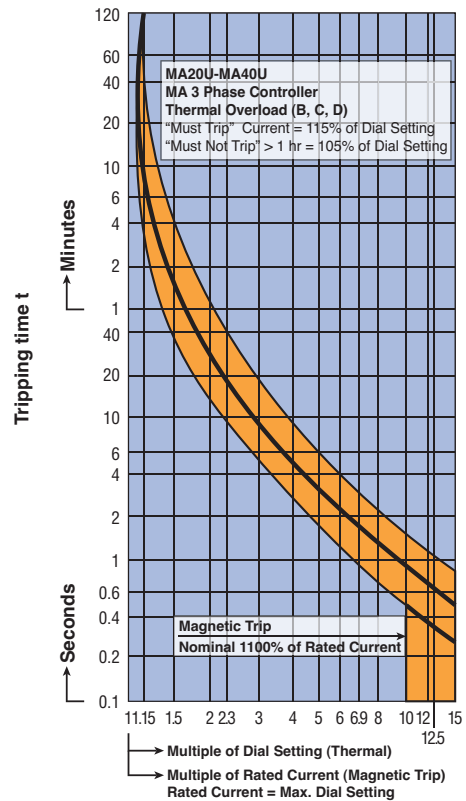
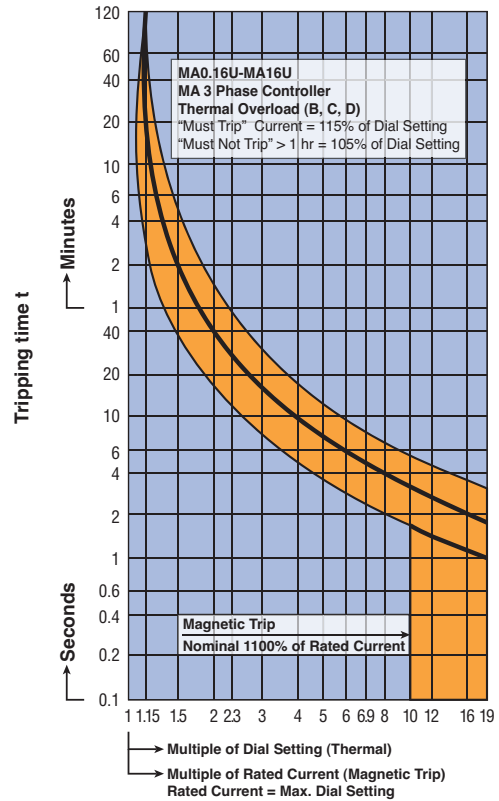

V-EA and MA Circuit Breaker Accessories



UL508 listed
E137938



FA - Shunt Trip

Type/ Cat. No.	Trip/Coil Voltage AC or DC	Max. Coil Current	Approvals
FA12U	12V	1.3A	UL Ⓢ
FA24U	24V	0.6A	UL Ⓢ
FA48U	48-72V	0.2A	UL Ⓢ
FA110U	110V/220V	0.25A/0.5A	UL Ⓢ

Std.Pk.: 1
Unit Weight: 120 grams (0.27 lb.)
Width: 17.5mm (.689in.)

UA - Undervoltage Trip (not UL listed)

Type/ Cat. No.	Line Voltage 60Hz*
UA120	120VAC
UA240	240VAC
UA277	277VAC
UA415	415VAC
UA480	480VAC

Std.Pk.: 1
Unit Weight: 70 grams (0.16 lb.)
Width: 17.5mm (.689in.)

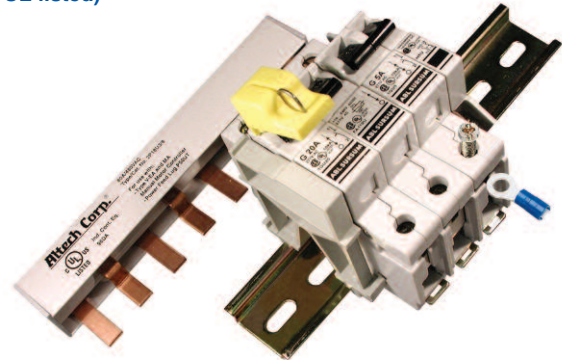

For further Busbar information please see pages 56-73 or our comprehensive Altech Universal Power Distribution catalog.



H - Auxiliary Switch

Type/ Cat. No.	Contact Rating	Wire Size	Approvals	For Use With:
H11U	10A / 220V AC 3A / 110V DC or pulsed 1A / 220V DC or pulsed	4mm ² (12 AWG)	UL Ⓢ	V-EA, MA

Std. Pk.: 1
Unit Weight: 45 grams (0.12 lb.)
Width: 9mm (.354in.)



Lock-out ** Cat. No. EASS

Prevent inadvertent resetting of the V-EA or MA during maintenance.
Fits 1/4" pad lock.



Cooling Spacer Cat. No. 15.960



* Please consult Altech for your 50Hz application needs.

** V-EA and MA can also be locked in the on and off position by simply using a common lead or meter seal, which gets fed through the hole in the handle and a corresponding hole in the housing.

TEMPERATURE CORRECTION CURVE

Ambient Temperature and Adjacent Mounting/Loading Adjustment

(V-EA/MA Ambient Temperature - 25°C to 55°C, Storage Temperature -40°C to 70°C)

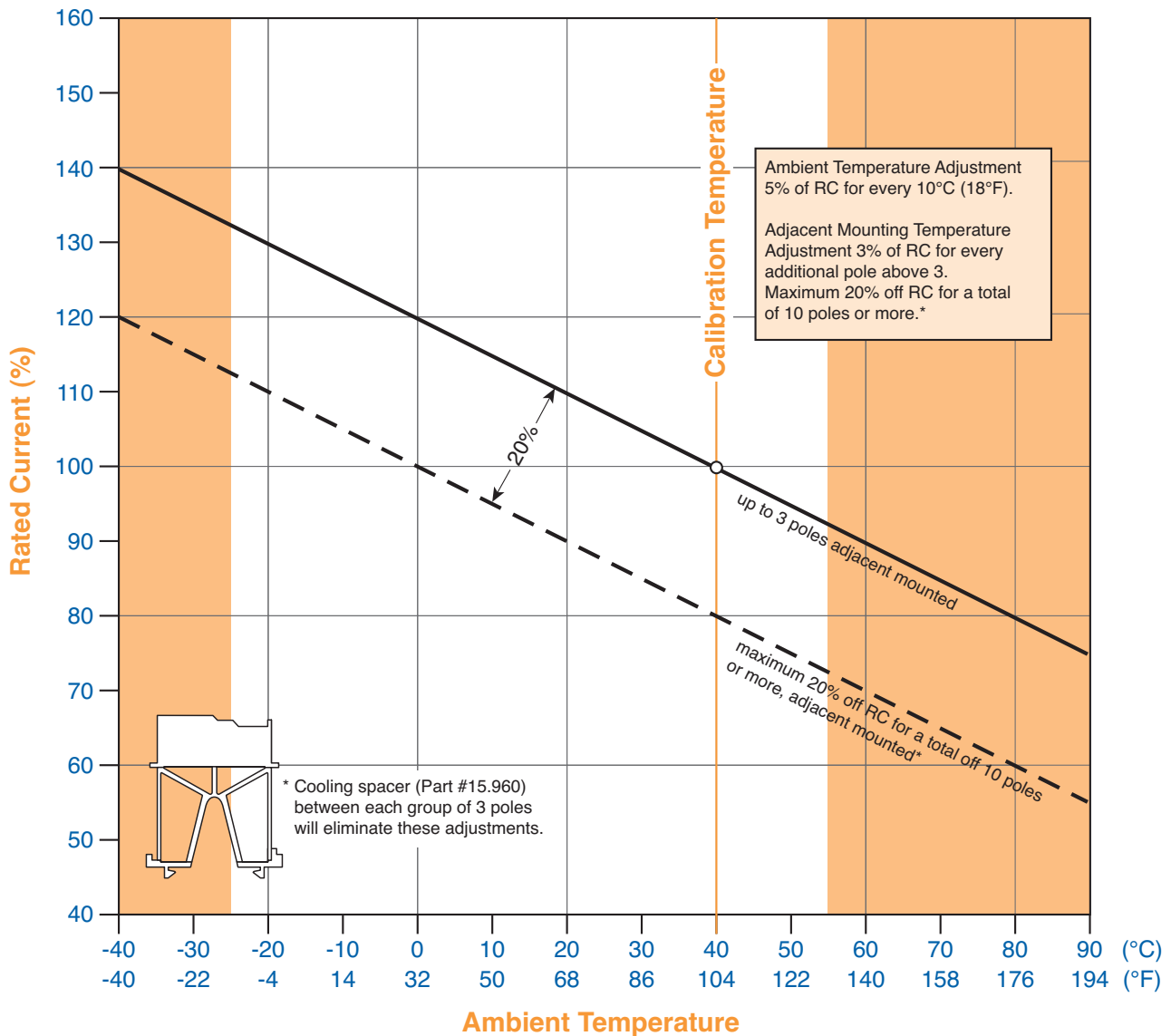

MS-Series Three Phase Adjustable Trip Economy Manual Motor Controllers

with overload and short circuit protection,
phase failure sensitivity according to
IEC 947-4-1, DIN VDE 0660 Part 102

With its high breaking capacity and current limitation the MS Manual Motor Controllers provide optimum protection for electrical motors as well as for other consumer units up to 25 amps. They are equipped with phase failure sensitivity, isolating and main switch functions. 13 ranges cover nominal rated currents from 0.1 up to 25 amps. The MS's are temperature compensated; the trip current of the magnetic part is $12 \times I_n$. The Manual Motor Controllers are built in accordance with IEC 947.



Type Designation

MS 016
(a) (b)

(a) = MS - Manual Motor
Controller
(b) = Rated Current

Type/ Cat. No.	Rated Current	Overload release adjustment/FLA (A)	Instantaneous setting (A)	3Ø Horsepower Rating				
				115V	200V	230V	480V	600V
MS016	0.16	0.1 - 0.16	1.92	Ampere rated for motor circuits having a full-load-amperage (FLA) not exceeding the MS's general purpose rated current and a locked rotor current not exceeding 6 times the MS's rated current.				
MS025	0.25	0.16 - 0.25	3					
MS04	0.4	0.25 - 0.4	4.8					
MS063	0.63	0.4 - 0.63	7.6					
MS1	1.0	0.63 - 1	12		1/2hp	1/2hp		
MS1.6	1.6	1 - 1.6	19.2		3/4hp	1hp		
MS2.5	2.5	1.6 - 2.5	30		1/2hp	1/2hp	1hp	1 1/2hp
MS4	4.0	2.5 - 4	48	1/2hp	3/4hp	1hp	2hp	3hp
MS6.3	6.3	4 - 6.3	75.6	3/4hp	1 1/2hp	1 1/2hp	3hp	5hp
MS10	10.0	6.3 - 10	120	1hp	2hp	3hp	5hp	7 1/2hp
MS16	16.0	10 - 16	192	2hp	3hp	5hp	10hp	10hp
MS20	20.0	16 - 20	240	3hp	5hp	7 1/2hp	15hp	-
MS25	25.0	20 - 25	300	3hp	5hp	7 1/2hp	15hp	-

Maximum Voltage	600V AC (MS20 and MS25, 480V AC)
Interrupting Capacity (UL/CSA Rating)	5kA
Group Short Circuit (UL/CSA - Ratings)	5kA
Interrupting Capacity (VDE - Ratings)	0.16-6.3A: Self protected 10-25A: 6kA
Mechanical Endurance	10000 on/off operations
Standard Pack and Weight	1/250g (0.55lb)
Terminal Size Acceptability	14-10 AWG
Terminal Torque	1.8Nm (16lb. in.)

Dimensions

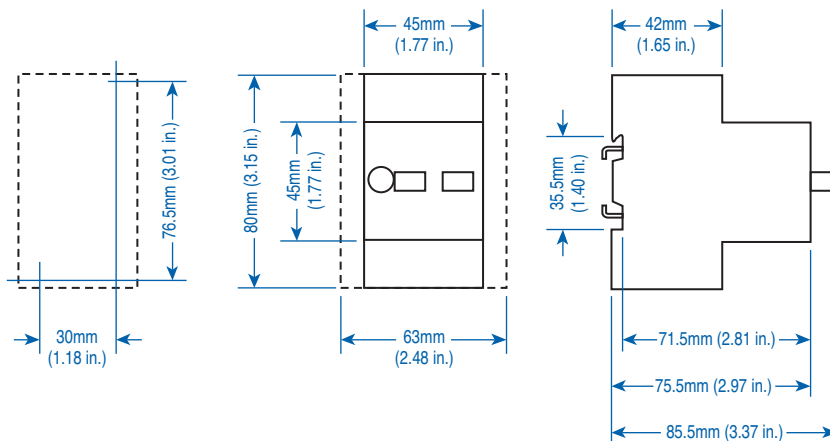

Accessories
MS Three Phase
Adjustable Trip Economy
Manual Motor Controllers



Auxiliary contact blocks for side mounting (3.5A/230VAC; 2A/400V AC)

Width mm	Contacts	Type/Cat. No.	Weight g/pc.	Std. Pk.
9	2NO	HMS20	40	10
9	1NO + 1NC	HMS11	40	10
9	1NO	HMS10	35	10
9	2NC	HMS02	40	10
9	1NC	HMS01	35	10



Insulated Enclosure IP55
 with integrated PE(N) terminal;
 top and bottom each have 2 metric
 knock-outs

Type/Cat. No.	Weight g/pc.	Std. Pk.
MS.G55	240	1



Emergency-Stop
 twist or key to release,
 red on yellow background

Release Type	Type/Cat. No.	Weight g/pc.	Std. Pk.
Twist	MS.PV	60	5
Key	MS.PS2	65	5



Flush Mounting Enclosure IP55
 with integrated PE(N) terminal

Type/Cat. No.	Weight g/pc.	Std. Pk.
MS.F55	170	1



Indicator Light
 with neon bulb, nominal rated voltage:
 220 - 240V or 380 - 440V

Color	Type/Cat. No.	Weight g/pc.	Std. Pk.
	220-240V	380-440V	
trans	MS.SLW2	MS.SLW3	10 5
green	MS.SLG2	MS.SLG3	10 5
red	MS.SLR2	MS.SLR3	10 5
yellow	MS.SLJ2	MS.SLJ3	10 5

Busbar



Busbar 63A	for 2 MS	Type/Cat. No. for 3 MS	for 4 MS	for 5 MS
no spacing	G45-14-2	G45-14-3	G45-14-4	G45-14-5
with auxiliary switch (1/2 pole) spacing	G54-14-2	G54-14-3	G54-14-4	G54-14-5



Power Feed Block

Type/Cat. No.	Rating (A)	Std. Pk.
GE2-14	63A	1