



HX1003

418.0 MHz Hybrid Transmitter

- **Ideal for 418.0 MHz Unlicensed Transmitters in the UK and USA**
- **Meets the Most Stringent European Remote-Control Regulations**
- **Compact, Surface-Mount Case with <math><90\text{ mm}^2</math> Footprint**

The HX1003 is a miniature transmitter module that generates on-off keyed (OOK) modulation from an external digital encoder (not included). The carrier frequency is quartz, surface-acoustic-wave (SAW) stabilized, and output harmonics are suppressed by a SAW filter. The result is excellent performance in a simple-to-use, surface-mount device with a low external component count. The HX1003 is designed specifically for unlicensed remote-control and wireless security transmitters operating at 418.0 MHz in the United Kingdom under DTI MPT 1340 regulations and in the USA under FCC Part 15 regulations.

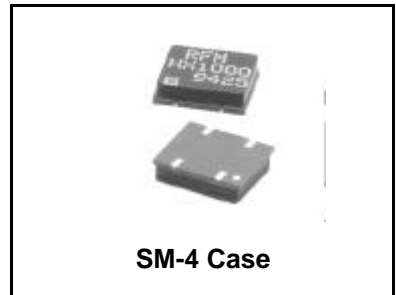

Absolute Maximum Ratings

Rating	Value	Units
Power Supply and/or Modulation Input Voltage	10	V
Nonoperating Case Temperature	-40 to +85	°C
Ten-Second Soldering Temperature	230	°C

Electrical Characteristics

Characteristic		Sym	Notes	Minimum	Typical	Maximum	Units	
Operating Frequency	Absolute Frequency	f_O	1, 2, 3, 4,	417.900		418.100	MHz	
	Tolerance from 418.0 MHz	Δf_O	10			± 100	kHz	
RF Output Power into 50 Ω at 25°C	Within Specified Temperature Range	P_O	2, 4, 5, 10	-3	0		dBm	
			2, 3, 4, 5	-5	0			
Harmonic Spurious Emissions			2, 3, 4, 5		-45	-35	dBc	
Modulation Input	Input HIGH Voltage	V_{IH}	3, 4, 5	2.5		V_{CC}	V	
	Input LOW Voltage	V_{IL}		0.0		0.3		
	Input HIGH Current	I_{IH}					100	μ A
	Input LOW Current	I_{IL}		0.0				
Data Timing Parameters	Modulation Rise Time	t_R	3, 4, 5, 6			100	μ s	
	Modulation Fall Time	t_F				100		
Power Supply	Voltage	V_{CC}	5, 7	2.7	3	3.3	VDC	
	Peak Current	I_{CC}	3, 4, 5, 8		7	10	mA	
	Standby Current		5, 9			1.0	μ A	
Operating Case Temperature Range		T_C	5	-40		+85	°C	
Lid Symbolization (in addition to Lot and/or Date Codes)				RFM HX1003				

 **CAUTION: Electrostatic Sensitive Device. Observe precautions for handling.**

NOTES:

1. One or more of the following United States patents apply: 4,454,488; 4,616,197; 4,670,681; and 4,760,352.
2. Typically, equipment utilizing this device requires emissions testing and government approval, which is the responsibility of the equipment manufacturer.
3. Applies over the specified range of operating temperature.
4. Applies over the specified range of operating power supply voltage.
5. The design, manufacturing process, and specifications of this device are subject to change without notice.
6. The maximum modulation bandwidth (and data rate) is dependent on the characteristics of the external encoding circuitry (not included).
8. Unless noted otherwise, case temperature $T_C = +25^\circ\text{C} \pm 2^\circ\text{C}$, test load impedance = 50 Ω , and modulation input is at logic HIGH. The maximum operating current occurs at the maximum specified power supply voltage and maximum specified operating temperature.
9. Standby current is defined as the supply current consumed with the modulation input at logic LOW.
10. Improper antenna loading affects performance of HX device.

Electrical Connections

Terminal Number	Connections
1	Data Input
2	+DC Supply
3	Ground
4	RF Output to 50 Ω

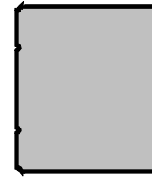
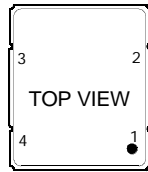

Footprint

Block Diagram

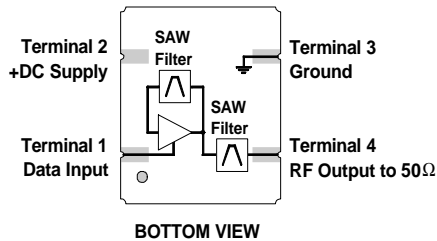

Typical Test Circuit

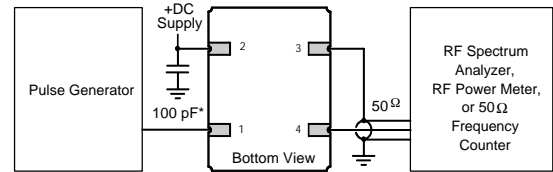

***Note:** Bypass required only for "HX2..." series transmitters in the 902 to 928 MHz band.

Case Design

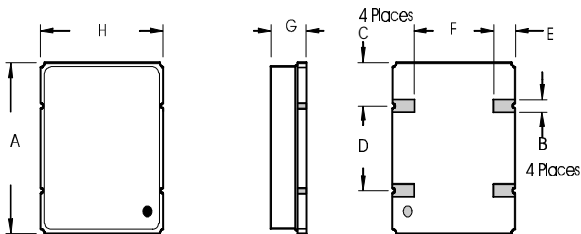

Dimensions	Millimeters		Inches	
	Min	Max	Min	Max
A		10.67		0.420
B	1.27 Nominal		0.050 Nominal	
C	2.67 Nominal		0.105 Nominal	
D	5.08 Nominal		0.200 Nominal	
E	1.70 Nominal		0.067 Nominal	
F	5.36 Nominal		0.211 Nominal	
G		2.80		0.110
H		9.02		0.355

Typical Transmitter Application

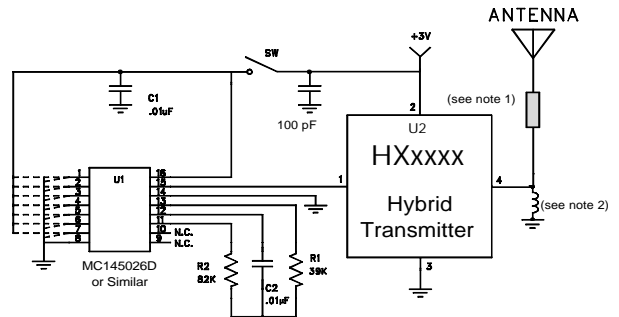

Notes:

1. This matching component is required only for antennas that are not 50 ohms. It is typically a chip inductor to match to stub antennas shorter than 1/4 wavelength. For very low radiated field-strength applications, a resistor can also be used.
2. For ESD protection.