



LM2596 Simple switcher Power Converter 150kHz 3A Step-Down Voltage Regulator

GENERAL DESCRIPTION

The LM2596 series of regulators are monolithic integrated circuits that provide all the active functions for a step-down (buck) switching regulator, capable of driving a 3A load with excellent line and load regulation. These devices are available in fixed output voltages of 3.3V, 5V, 12V, and an adjustable output version. Requiring a minimum number of external components, these regulators are simple to use and include internal frequency compensation, and a fixed-frequency oscillator. The LM2596 series operates at a switching frequency of 150 kHz thus allowing smaller sized filter components than what would be needed with lower frequency switching regulators. Available in a standard 5-lead TO-220 package with several different lead bend options, and a 5-lead TO-263 surface mount package.

A standard series of inductors are available from several different manufacturers optimized for use with the LM2596 series. This feature greatly simplifies the design of switch-mode power supplies.

Other features include a guaranteed $\pm 4\%$ tolerance on output voltage under specified input voltage and output load conditions, and $\pm 15\%$ on the oscillator frequency. External shutdown is included, featuring typically 80 μA standby current. Self protection features include a two stage frequency reducing current limit for the output switch and an over temperature shutdown for complete protection under fault conditions.

FEATURES

- 3.3V, 5V, 12V, and adjustable output versions
- Adjustable version output voltage range, 1.2V to 37V
- $\pm 4\%$ max over line and load conditions
- Available in TO-220 and TO-263 packages
- Guaranteed 3A output load current
- Input voltage range up to 40V
- Requires only 4 external components
- Excellent line and load regulation specifications
- 150 kHz fixed frequency internal oscillator
- TTL shutdown capability
- Low power standby mode, I_Q typically 80 μA
- High efficiency
- Uses readily available standard inductors
- Thermal shutdown and current limit protection

APPLICATIONS

- Simple high-efficiency step-down (buck) regulator
- On-card switching regulators
- Positive to negative converter

TYPICAL APPLICATION (Fixed Output Voltage Versions)

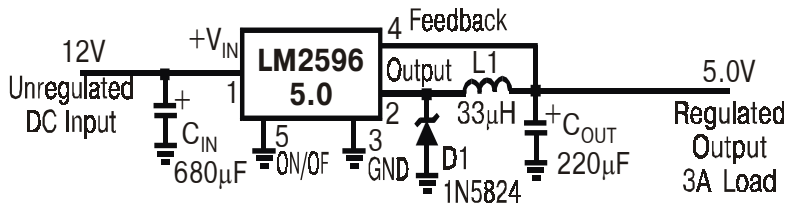

BLOCK DIAGRAM

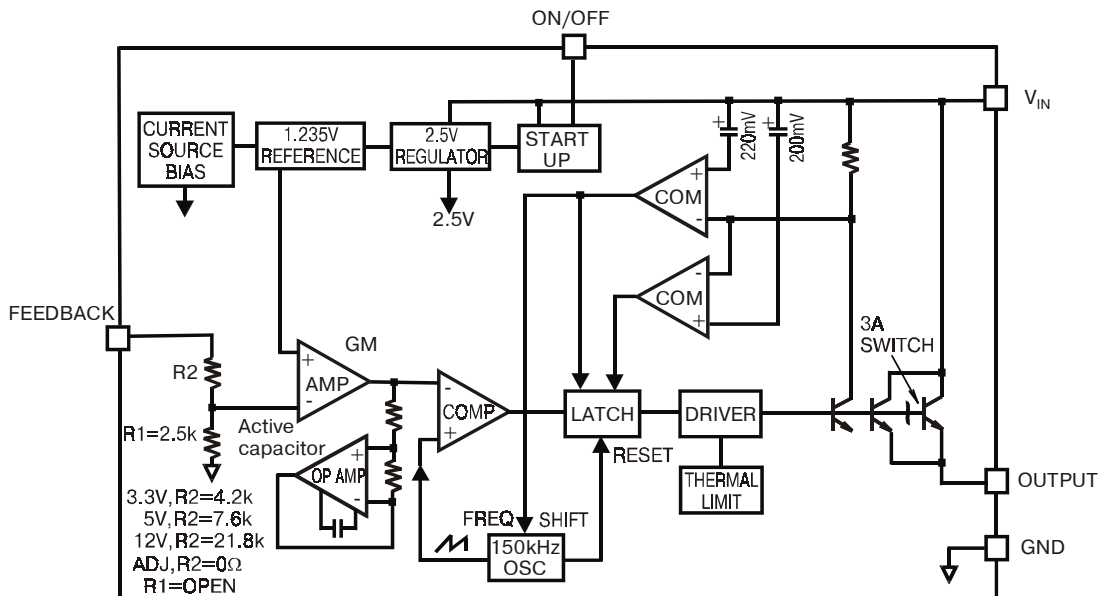



LM2596 Simple switcher Power Converter 150kHz 3A Step-Down Voltage Regulator

PIN FUNCTIONS

+V_{IN} - This is the positive input supply for the IC switching regulator. A suitable input bypass capacitor must be present at this pin to minimize voltage transients and to supply the switching currents needed by the regulator.

Ground - Circuit ground.

Output - Internal switch. The voltage at this pin switches between (+V_{IN} - V_{SAT}) and approximately -0.5V, with a duty cycle of approximately V_{OUT}/V_{IN}. To minimize coupling to sensitive circuitry, the PC board copper area connected to this pin should be kept to a minimum.

Feedback —Senses the regulated output voltage to complete the feedback loop.

ON/OFF - Allows the switching regulator circuit to be shut down using logic level signals thus dropping the total input supply current to approximately 80 μ A. Pulling this pin below a threshold voltage of approximately 1.3V turns the regulator on, and pulling this pin above 1.3V (up to a maximum of 25V) shuts the regulator down. If this shutdown feature is not needed, the ON /OFF pin can be wired to the ground pin or it can be left open, in either case the regulator will be in the ON condition.

ABSOLUTE MAXIMUM RATINGS (Note 1)

Maximum Supply Voltage	45V
ON /OFF Pin Input Voltage	-0.3 \leq V \leq +25V
Feedback Pin Voltage	-0.3 \leq V \leq +25V
Output Voltage to Ground (Steady State)	-1V
Power Dissipation	Internally limited
Storage Temperature Range	-65°C to +150°C
ESD Susceptibility	
Human Body Model (Note 2)	2 kV
Lead Temperature S Package	
Vapor Phase (60 sec.)	+215°C
Infrared (10 sec.)	+245°C
T Package (Soldering, 10 sec.)	+260°C
Maximum Junction Temperature	+150°C

OPERATING CONDITIONS

Temperature Range	-40°C \leq T _J \leq +125°C
Supply Voltage	4.5V to 40V

LM2596-3.3

ELECTRICAL CHARACTERISTICS

Specifications with standard type face are for T_J = 25°C, and those with **boldface type** apply over **full Operating Temperature Range**

Symbol	Parameter	Conditions	LM2596-3.3		Units (Limits)
			Typ (Note 3)	Limit (Note 4)	
SYSTEM PARAMETERS (Note 5) Test Circuit Figure 1					
V _{OUT}	Output Voltage	4.7V \leq V _{IN} \leq 40V, 0.2A \leq I _{LOAD} \leq 3A	3.3	3.168/ 3.135 3.432/ 3.465	V V(min) V(max)
η	Efficiency	V _{IN} =12V, I _{LOAD} =3A	73		%

LM2596-5.0

ELECTRICAL CHARACTERISTICS

Specifications with standard type face are for T_J = 25°C, and those with **boldface type** apply over **full Operating Temperature Range**

Symbol	Parameter	Conditions	LM2596-5.0		Units (Limits)
			Typ (Note 3)	Limit (Note 4)	
SYSTEM PARAMETERS (Note 5) Test Circuit Figure 1					
V _{OUT}	Output Voltage	7V \leq V _{IN} \leq 40V, 0.2A \leq I _{LOAD} \leq 3A	5.0	4.800/ 4.750 5.200/ 5.250	V V(min) V(max)
η	Efficiency	V _{IN} =12V, I _{LOAD} =3A	80		%

LM2596-12

ELECTRICAL CHARACTERISTICS

Specifications with standard type face are for T_J = 25°C, and those with **boldface type** apply over **full Operating Temperature Range**

Symbol	Parameter	Conditions	LM2596-12		Units (Limits)
			Typ (Note 3)	Limit (Note 4)	
SYSTEM PARAMETERS (Note 5) Test Circuit Figure 1					
V _{OUT}	Output Voltage	15V \leq V _{IN} \leq 40V, 0.2A \leq I _{LOAD} \leq 3A	12.0	11.52/ 11.40 12.48/ 12.60	V V(min) V(max)
η	Efficiency	V _{IN} =12V, I _{LOAD} =3A	90		%



LM2596 Simple switcher Power Converter 150kHz 3A Step-Down Voltage Regulator

LM2596-ADJ

ELECTRICAL CHARACTERISTICS

Specifications with standard type face are for $T_J = 25^{\circ}\text{C}$, and those with **boldface type** apply over **full Operating Temperature Range**

Symbol	Parameter	Conditions	LM2596-ADJ		Units (Limits)
			Typ (Note 3)	Limit (Note 4)	
SYSTEM PARAMETERS (Note 5) Test Circuit Figure 1					
V_{OUT}	Output Voltage	$4.5\text{V} \leq V_{\text{IN}} \leq 40\text{V}$, $0.2\text{A} \leq I_{\text{LOAD}} \leq 3\text{A}$ V_{OUT} programmed for 3V. Circuit of Figure 1.	1.230	1.193/ 1.180 1.267/ 1.280	V V(min) V(max)
η	Efficiency	$V_{\text{IN}}=12\text{V}$, $V_{\text{OUT}}=3\text{V}$, $I_{\text{LOAD}}=3\text{A}$	73		%

ALL OUTPUT VOLTAGE VERSIONS

ELECTRICAL CHARACTERISTICS

Specifications with standard type face are for $T_J = 25^{\circ}\text{C}$, and those with **boldface type** apply over **full Operating Temperature Range**. Unless otherwise specified, $V_{\text{IN}} = 12\text{V}$ for the 3.3V, 5V, and Adjustable version and $V_{\text{IN}} = 24\text{V}$ for the 12V version. $I_{\text{LOAD}} = 500\text{ mA}$

Symbol	Parameter	Conditions	LM2596-XX		Units (Limits)
			Typ (Note 3)	Limit (Note 4)	
DEVICE PARAMETERS					
I_{b}	Feedback Bias Current	Adjustable Version Only, $V_{\text{FB}}=1.3\text{V}$	10	50/ 100	nA nA (max)
f_{O}	Oscillator Frequency	(Note 6)	150	127/ 110 173/ 173	kHz kHz (min) kHz (max)
V_{SAT}	Saturation Voltage	$I_{\text{OUT}}=3\text{A}$ (Notes 7, 8)	1.16	1.4/ 1.5	V V (max)
DC	Max Duty Cycle (ON) Min Duty Cycle (OFF)	(Note 8) (Note 9)	100 0		%
I_{CL}	Current Limit	Peak Current (Notes 7, 8)	4.5	3.6/ 3.4 6.9/ 7.5	A A (min) A (max)
I_{L}	Output Leakage Current	Output=0V (Notes 7, 9)		50	μA (max)
		Output=-1V (Note 10)	2	30	mA (max)
I_{Q}	Quiescent Current	(Note 9)	5	10	mA (max)
				80	200/ 250
I_{STBY}	Standby Quiescent Current	ON/OFF pin=5V (OFF) (Note 10)	80	200/ 250	μA μA (max)
θ_{JC} θ_{JA} θ_{JA} θ_{JA} θ_{JA}	Thermal Resistance	TO-220 or TO-263 Package, Junction to Case	2		$^{\circ}\text{C}/\text{W}$
		TO-220 Package, Junction to Ambient (Note 11)	50		$^{\circ}\text{C}/\text{W}$
		TO-263 Package, Junction to Ambient (Note 12)	50		$^{\circ}\text{C}/\text{W}$
		TO-263 Package, Junction to Ambient (Note 13)	30		$^{\circ}\text{C}/\text{W}$
		TO-263 Package, Junction to Ambient (Note 14)	20		$^{\circ}\text{C}/\text{W}$
ON/OFF CONTROL Test Circuit Figure 1					
V_{IH} V_{IL}	ON/OFF Pin Logic Input Threshold Voltage	Low (Regulator ON)	1.3	0.6	V (max)
		High (Regulator OFF)		2.0	V (min)
I_{H}	ON/OFF Pin Input Current	$V_{\text{LOGIC}}=2.5\text{V}$ (Regulator OFF)	5	15	μA μA (max)
I_{L}		$V_{\text{LOGIC}}=0.5\text{V}$ (Regulator ON)	0.02	5	μA μA (max)

Note 1: Absolute Maximum Ratings indicate limits beyond which damage to the device may occur. Operating Ratings indicate conditions for which the device is intended to be functional, but do not guarantee specific performance limits. For guaranteed specifications and test conditions, see the Electrical Characteristics.

Note 2: The human body model is a 100 pF capacitor discharged through a 1.5k resistor into each pin.

Note 3: Typical numbers are at 25°C and represent the most likely norm.

Note 4: All limits guaranteed at room temperature (standard type face) and at temperature extremes (bold type face). All room temperature limits are 100% production tested. All limits at temperature extremes are guaranteed via correlation using standard Statistical Quality Control (SQC) methods. All limits are used to calculate Average Outgoing Quality Level (AOQL).

Note 5: External components such as the catch diode, inductor, input and output capacitors, and voltage programming resistors can affect switching regulator system performance. When the LM2596 is used as



LM2596 Simple Switcher Power Converter 150kHz 3A Step-Down Voltage Regulator

shown in the Figure 1 test circuit, system performance will be as shown in system parameters section of Electrical Characteristics.

Note 6: The switching frequency is reduced when the second stage current limit is activated. The amount of reduction is determined by the severity of current over-load.

Note 7: No diode, inductor or capacitor connected to output pin.

Note 8: Feedback pin removed from output and connected to 0V to force the output transistor switch ON.

Note 9: Feedback pin removed from output and connected to 12V for the 3.3V, 5V, and the ADJ. version, and 15V for the 12V version, to force the output transistor switch OFF.

Note 10: $V_{IN} = 40V$.

Note 11: Junction to ambient thermal resistance (no external heat sink) for the TO-220 package mounted vertically, with the leads soldered to a printed circuit board with (1 oz.) copper area of approximately 1 in²

Note 12: Junction to ambient thermal resistance with the TO-263 package tab soldered to a single printed circuit board with 0.5 in² of (1 oz.) copper area.

Note 13: Junction to ambient thermal resistance with the TO-263 package tab soldered to a single sided printed circuit board with 2.5 in² of (1 oz.) copper area.

Note 14: Junction to ambient thermal resistance with the TO-263 package tab soldered to a double sided printed circuit board with 3 in² of (1 oz.) copper area on the LM2596S side of the board, and approximately 16 in² of copper on the other side of the p-c board.

TYPICAL PERFORMANCE CHARACTERISTICS (Circuit of Figure 1)

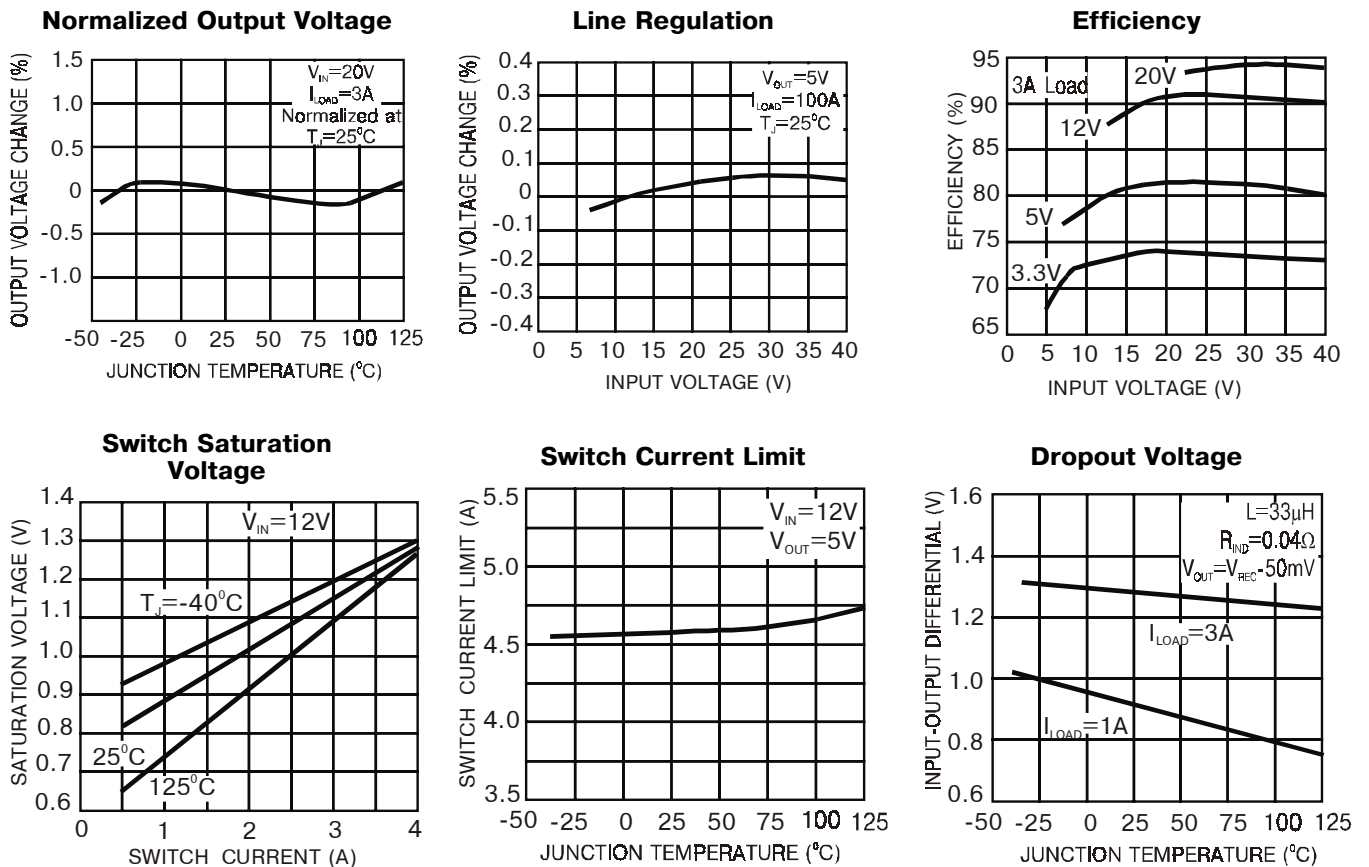



LM2596 Simple Switcher Power Converter 150kHz 3A Step-Down Voltage Regulator

TYPICAL PERFORMANCE CHARACTERISTICS (Circuit of Figure 1) (Continued)

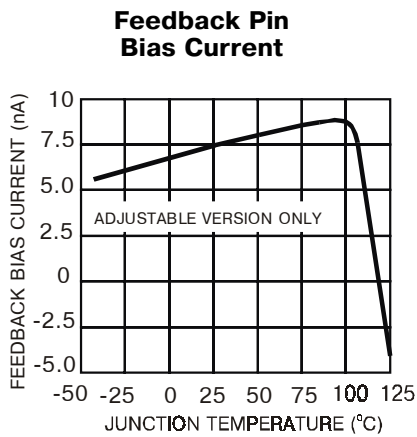
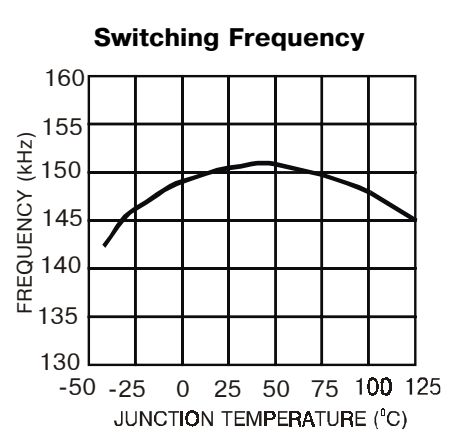
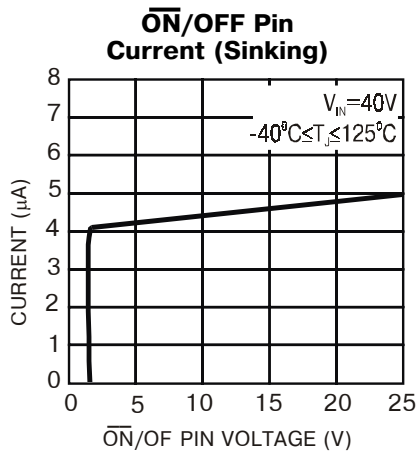
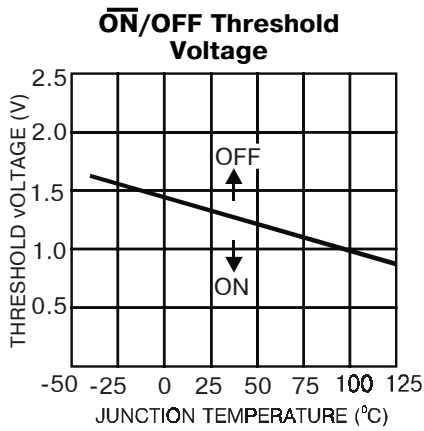
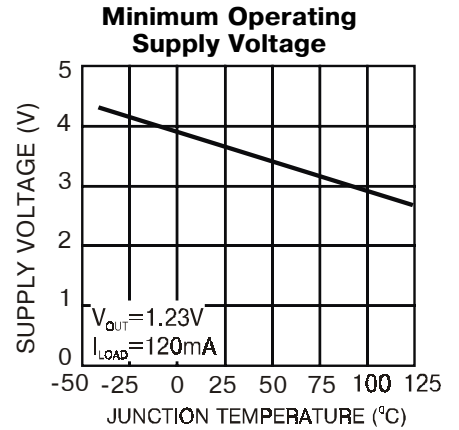
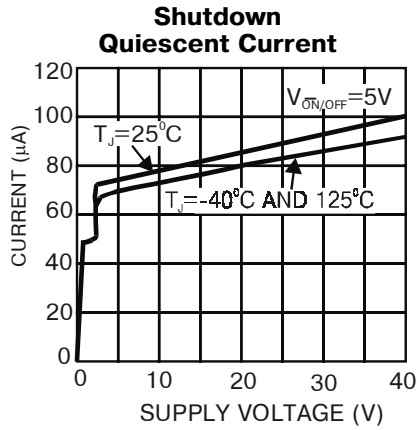
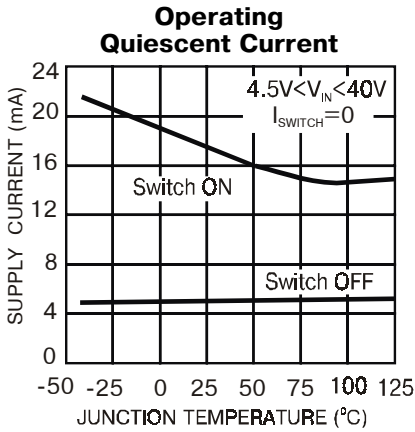



LM2596 Simple switcher Power Converter 150kHz 3A Step-Down Voltage Regulator

TYPICAL PERFORMANCE CHARACTERISTICS

Continuous Mode Switching Waveforms
 $V_{IN}=20V$, $V_{OUT}=5V$, $I_{LOAD}=2A$
 $L=32\mu H$, $C_{OUT}=220\mu F$, $C_{OUT}ESR=50m\Omega$

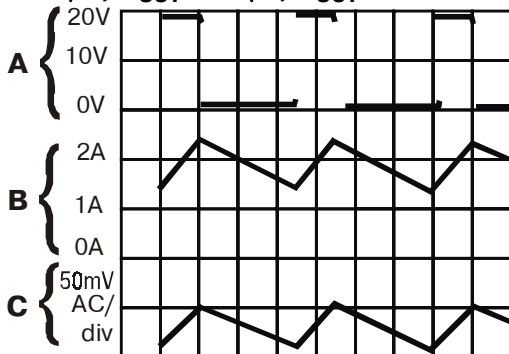

A: Output Pin Voltage, 10V/div
 B: Inductor Current 1A/div
 C: Output Ripple Voltage, 50mV/div

Horizontal Time Base: 2 μ s/div

Discontinuous Mode Switching Waveforms
 $V_{IN}=20V$, $V_{OUT}=5V$, $I_{LOAD}=500mA$
 $L=10\mu H$, $C_{OUT}=330\mu F$, $C_{OUT}ESR=45m\Omega$

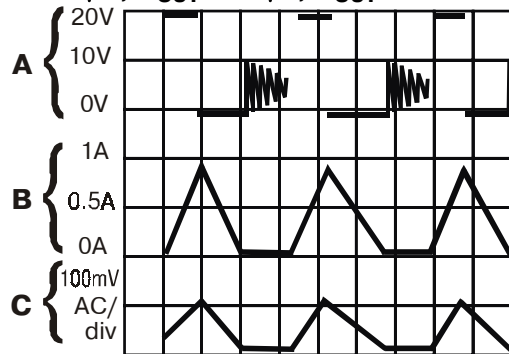

A: Output Pin Voltage, 10V/div
 B: Inductor Current 1A/div
 C: Output Ripple Voltage, 100mV/div

Horizontal Time Base: 2 μ s/div

Load Transient Response for Continuous Mode
 $V_{IN}=20V$, $V_{OUT}=5V$, $I_{LOAD}=500mA$ to 2A
 $L=32\mu H$, $C_{OUT}=220\mu F$, $C_{OUT}ESR=50m\Omega$

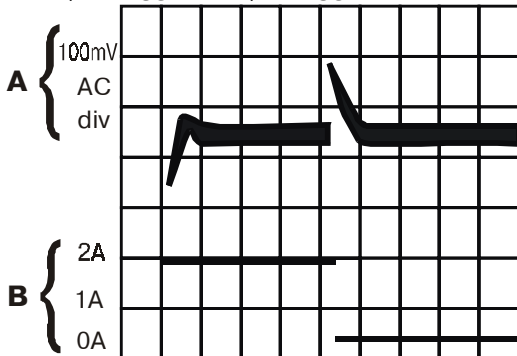

A: Output Voltage, 100mV/div.(AC)
 B: 500mA to 2A Load Pulse

Horizontal Time Base: 100 μ s/div

Load Transient Response for Discontinuous Mode
 $V_{IN}=20V$, $V_{OUT}=5V$, $I_{LOAD}=500mA$ to 2A
 $L=10\mu H$, $C_{OUT}=330\mu F$, $C_{OUT}ESR=45m\Omega$

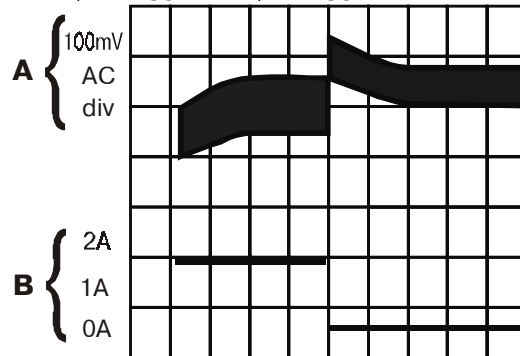

A: Output Voltage, 100mV/div. (AC)
 B: 500mA to 2A Load Pulse

Horizontal Time Base: 200 μ s/div



LM2596 Simple switcher Power Converter 150kHz 3A Step-Down Voltage Regulator

TEST CIRCUIT AND LAYOUT GUIDELINES

Fixed Output Voltage Versions

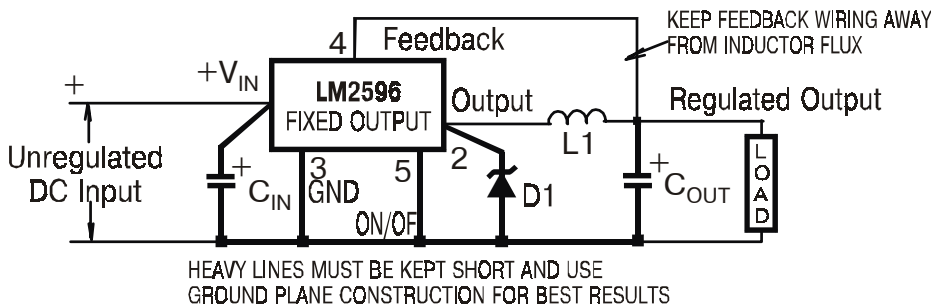

- C_{IN} - 470 μ F, 50V, Aluminum Electrolytic Nichicon "PL Series"
- C_{OUT} - 220 μ F, 25V, Aluminum Electrolytic Nichicon "PL Series"
- D1 - 5A, 40V Schottky Rectifier, 1N5825
- L1 - 68 μ H, L38

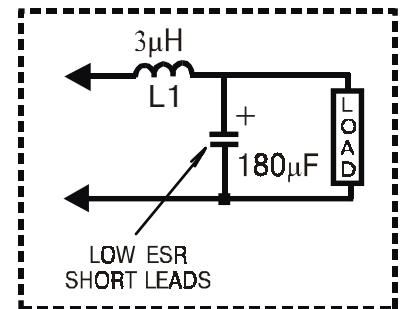

OPTIONAL POST RIPPLE FILTER

Adjustable Output Voltage Versions

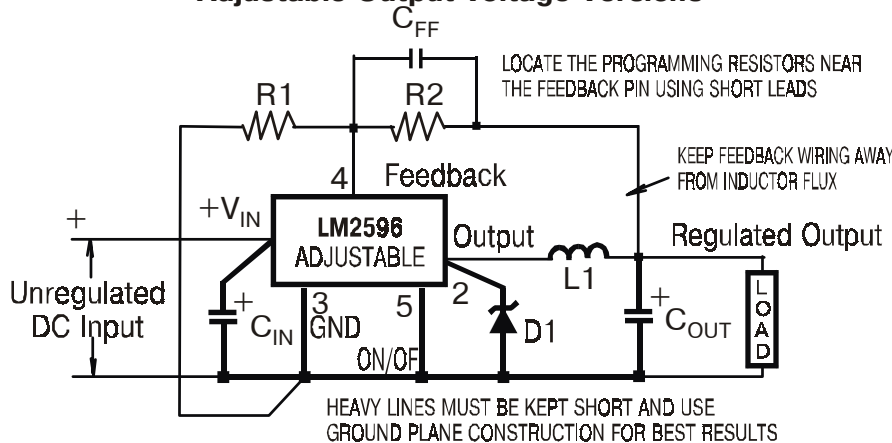

$$V_{OUT} = V_{REF} \left(1 + \frac{R_2}{R_1} \right)$$

where $V_{REF} = 1.23V$

$$R_2 = R_1 \left(\frac{V_{OUT}}{V_{REF}} - 1 \right)$$

- Select R1 to be approximately 1k Ω , use a 1% resistor for best stability.
- C_{IN} - 470 μ F, 50V, Aluminum Electrolytic Nichicon "PL Series"
- C_{OUT} - 220 μ F, 35V, Aluminum Electrolytic Nichicon "PL Series"
- D1 - 5A, 40V Schottky Rectifier, 1N5825
- L1 - 68 μ H, L38
- R1 - 1k Ω , 1%
- C_{FF} - see Application Information Section

Figure 1. Standard Test Circuits and Layout Guides

As in any switching regulator, layout is very important. Rapidly switching currents associated with wiring inductance can generate voltage transients which can cause problems. For minimal inductance and ground loops, the wires indicated by **heavy lines should be wide printed circuit traces and should be kept as short as possible.** For best results, external components should be located as close to the switcher IC as possible using ground plane construction or single point grounding.

If **open core inductors are used**, special care must be taken as to the location and positioning of this type of inductor. Allowing the inductor flux to intersect sensitive feedback, IC groundpath and C_{OUT} wiring can cause problems.

When using the adjustable version, special care must be taken as to the location of the feedback resistors and the associated wiring. Physically locate both resistors near the IC, and route the wiring away from the inductor, especially an open core type of inductor.



LM2596 Simple switcher Power Converter 150kHz 3A Step-Down Voltage Regulator

LM2596 SERIES BUCK REGULATOR DESIGN PROCEDURE (FIXED OUTPUT)

PROCEDURE (Fixed Output Voltage Version)	EXAMPLE (Fixed Output Voltage Version)
<p>Given: V_{OUT} = Regulated Output Voltage (3.3V, 5V or 12V) V_{IN} (max) = Maximum DC Input Voltage I_{LOAD} (max) = Maximum Load Current</p> <p>1. Inductor Selection (L1) A. Select the correct inductor value selection guide from Figures Figure 4, Figure 5, or Figure 6. (Output voltages of 3.3V, 5V, or 12V respectively.) For all other voltages, see the design procedure for the adjustable version. B. From the inductor value selection guide, identify the inductance region intersected by the Maximum Input Voltage line and the Maximum Load Current line. Each region is identified by an inductance value and an inductor code (LXX). C. Select an appropriate inductor from the four manufacturer's part numbers listed in Figure 8.</p> <p>2. Output Capacitor Selection (C_{OUT}) A. In the majority of applications, low ESR (Equivalent Series Resistance) electrolytic capacitors between 82 μF and 820 μF and low ESR solid tantalum capacitors between 10 μF and 470 μF provide the best results. This capacitor should be located close to the IC using short capacitor leads and short copper traces. Do not use capacitors larger than 820 μF. B. To simplify the capacitor selection procedure, refer to the quick design component selection table shown in Figure 2. This table contains different input voltages, output voltages, and load currents, and lists various inductors and output capacitors that will provide the best design solutions.</p> <p>C. The capacitor voltage rating for electrolytic capacitors should be at least 1.5 times greater than the output voltage, and often much higher voltage ratings are needed to satisfy the low ESR requirements for low output ripple voltage.</p> <p>3. Catch Diode Selection (D1) A. The catch diode current rating must be at least 1.3 times greater than the maximum load current. Also, if the power supply design must withstand a continuous output short, the diode should have a current rating equal to the maximum current limit of the LM2596. The most stressful condition for this diode is an overload or shorted output condition.</p>	<p>Given: V_{OUT} = 5V V_{IN} (max) = 12V I_{LOAD} (max) = 3A</p> <p>1. Inductor Selection (L1) A. Use the inductor selection guide for the 5V version shown in Figure 5. B. From the inductor value selection guide shown in Figure 5, the inductance region intersected by the 12V horizontal line and the 3A vertical line is 33 μH, and the inductor code is L40. C. The inductance value required is 33 μH. From the table in Figure 8, go to the L40 line and choose an inductor part number from any of the four manufacturers shown. (In most in-stance, both through hole and surface mount inductors are available.)</p> <p>2. Output Capacitor Selection (C_{OUT}) A. See section on output capacitors in application information section. B. From the quick design component selection table shown in Figure 2, locate the 5V output voltage section. In the load current column, choose the load current line that is closest to the current needed in your application, for this example, use the 3A line. In the maximum input voltage column, select the line that covers the input voltage needed in your application, in this example, use the 15V line. Continuing on this line are recommended inductors and capacitors that will provide the best overall performance. The capacitor list contains both through hole electrolytic and surface mount tantalum capacitors from four different capacitor manufacturers. It is recommended that both the manufacturers and the manufacturer's series that are listed in the table be used. In this example aluminum electrolytic capacitors from several different manufacturers are available with the range of ESR numbers needed. 330 μF 35V Panasonic HFQ Series 330 μF 35V Nichicon PL Series C. For a 5V output, a capacitor voltage rating at least 7.5V or more is needed. " ut even a low ESR, switching grade, 220μF 10V aluminum electrolytic capacitor would exhibit approximately 225 mW of ESR (see the curve in Figure 14 for the ESR vs voltage rating). This amount of ESR would result in relatively high output ripple voltage. To reduce the ripple to 1% of the output voltage, or less, a capacitor with a higher value or with a higher voltage rating (lower ESR) should be selected. A 16V or 25V capacitor will reduce the ripple volt-age by approximately half.</p> <p>3. Catch Diode Selection (D1) A. Refer to the table shown in Figure 11. In this example, a 5A, 20V, 1N5823 Schottky diode will provide the best performance, and will not be overstressed even for a shorted output.</p>
<p>B. The reverse voltage rating of the diode should be at least 1.25 times the maximum input voltage. C. This diode must be fast (short reverse recovery time)</p>	



LM2596 Simple switcher Power Converter 150kHz 3A Step-Down Voltage Regulator

PROCEDURE (Fixed Output Voltage Version)	EXAMPLE (Fixed Output Voltage Version)
<p>and must be located close to the LM2596 using short leads and short printed circuit traces. Because of their fast switching speed and low forward voltage drop, Schottky diodes provide the best performance and efficiency, and should be the first choice, especially in low output voltage applications.</p> <p>Ultra-fast recovery, or High-Efficiency rectifiers also provide good results. Ultra-fast recovery diodes typically have reverse recovery times of 50 ns or less. Rectifiers such as the 1N5400 series are much too slow and should not be used.</p> <p>4. Input Capacitor (C_{IN}) A low ESR aluminum or tantalum bypass capacitor is needed between the input pin and ground pin to prevent large volt-age transients from appearing at the input. This capacitor should be located close to the IC using short leads. In addition, the RMS current rating of the input capacitor should be selected to be at least 1/2 the DC load current. The capacitor manufacturers data sheet must be checked to assure that this current rating is not exceeded. The curve shown in Figure 9 shows typical RMS current ratings for several different aluminum electrolytic capacitor values.</p> <p>For an aluminum electrolytic, the capacitor voltage rating should be approximately 1.5 times the maximum input voltage.</p> <p>The tantalum capacitor voltage rating should be 2 times the maximum input voltage and it is recommended that they be surge current tested by the manufacturer.</p> <p>Use caution when using ceramic capacitors for input bypassing, because it may cause severe ringing at the V_{IN} pin.</p>	<p>4. Input Capacitor (C_{IN}) The important parameters for the Input capacitor are the input voltage rating and the RMS current rating. With a nominal input voltage of 12V, an aluminum electrolytic capacitor with a voltage rating greater than 18V (1.5 x V_{IN}) would be needed. The next higher capacitor voltage rating is 25V.</p> <p>The RMS current rating requirement for the input capacitor in a buck regulator is approximately 1 /2 the DC load current. In this example, with a 3A load, a capacitor with a RMS current rating of at least 1.5A is needed. The curves shown in Figure 9 can be used to select an appropriate input capacitor.</p> <p>From the curves, locate the 35V line and note which capacitor values have RMS current ratings greater than 1.5A. A 680UF/35V capacitor could be used.</p> <p>For a through hole design, a 680UF/35V electrolytic capacitor (Panasonic HFQ series or Nichicon PL series or equivalent) would be adequate. other types or other manufacturers capacitors can be used provided the RMS ripple current ratings are adequate.</p> <p>For surface mount designs, solid tantalum capacitors can be used, but caution must be exercised with regard to the capacitor surge current rating. The TPS series available from AVX, and the 593D series from Sprague are both surge current tested.</p>

LM2596 SERIES BUCK REGULATOR DESIGN PROCEDURE (FIXED OUTPUT) (Continued)

Conditions			Inductor		Output Capacitor			
					Through Hole Electrolytic		Surface Mount Tantalum	
Output Voltage (V)	Load Current (A)	Max Input Voltage (V)	Inductance (μH)	Inductor (#)	Panasonic HFQ Series (μF/V)	Nichicon PL Series (μF/V)	AVX TPS Series (μF/V)	Sprague 595D Series (μF/V)
3.3	3	5	22	L41	470/25	560/16	330/6.3	390/6.3
		7	22	L41	560/35	560/35	330/6.3	390/6.3
		10	22	L41	680/35	680/35	330/6.3	390/6.3
	2	40	33	L40	560/35	470/35	330/6.3	390/6.3
		6	22	L33	470/25	470/35	330/6.3	390/6.3
		10	33	L32	330/35	330/35	330/6.3	390/6.3
5	3	40	47	L39	330/35	270/50	220/10	330/10
		8	22	L41	470/25	560/16	220/10	330/10
		10	22	L41	560/25	560/25	220/10	330/10
	2	15	33	L40	330/35	330/35	220/10	330/10
		40	47	L39	330/35	270/35	220/10	330/10
		9	22	L33	470/25	560/16	220/10	330/10
12	3	20	68	L38	180/35	180/35	100/10	270/10
		40	68	L38	180/35	180/35	100/10	270/10
		15	22	L41	470/25	470/25	100/16	180/16
	2	18	33	L40	330/25	330/25	100/16	180/16
		30	68	L44	180/25	180/25	100/16	120/20
		40	68	L44	180/35	180/35	100/16	120/20
2	15	33	L32	330/25	330/25	100/16	180/16	
	20	68	L38	180/25	180/25	100/16	120/20	
	40	150	L42	82/25	82/25	68/20	68/25	

Figure 2. LM2596 Fixed Voltage Quick Design Component Selection Table

LM2596 SERIES BUCK REGULATOR DESIGN PROCEDURE (ADJUSTABLE OUTPUT)

PROCEDURE (Adjustable Output Voltage Version)	EXAMPLE (Adjustable Output Voltage Version)
<p>Given: V_{OUT} = Regulated Output Voltage V_{IN(max)} = Maximum Input Voltage</p>	<p>Given: V_{OUT} = 20V V_{IN(max)} = 28V</p>



LM2596 Simple switcher Power Converter 150kHz 3A Step-Down Voltage Regulator

PROCEDURE (Adjustable Output Voltage Version)	EXAMPLE (Adjustable Output Voltage Version)
<p>$I_{LOAD(max)}$ = Maximum Load Current F = Switching Frequency (Fixed at a nominal 150 kHz).</p> <p>1. Programming Output Voltage (Selecting R_1 and R_2, as shown in Figure 1) Use the following formula to select the appropriate resistor values.</p> $V_{OUT} = V_{REF} \left(1 + \frac{R_2}{R_1} \right) \quad \text{where } V_{REF} = 1.23 \text{ V}$ <p>Select a value for R_1 between 240Ω and 1.5kΩ. The lower resistor values minimize noise pickup in the sensitive feedback pin. (For the lowest temperature coefficient and the best stability with time, use 1% metal film resistors.)</p> $R_2 = R_1 \left(\frac{V_{OUT}}{V_{REF}} - 1 \right)$ <p>2. Inductor Selection (L1) A. Calculate the inductor Volt • microsecond constant $E \cdot T$ ($V \cdot \mu s$), from the following formula:</p> $E \cdot T = (V_{IN} - V_{OUT} - V_{SAT}) \cdot \frac{V_{OUT} + V_D}{V_{IN} - V_{SAT} + V_D} \cdot \frac{1000}{150 \text{ kHz}} (V \cdot \mu s)$ <p>where V_{SAT} = internal switch saturation voltage = 1.16V and V_D = diode forward voltage drop = 0.5V</p> <p>B. Use the $E \cdot T$ value from the previous formula and match it with the $E \cdot T$ number on the vertical axis of the Inductor Value Selection Guide shown in Figure 7. C. on the horizontal axis, select the maximum load current. D. Identify the inductance region intersected by the $E \cdot T$ value and the Maximum Load Current value. Each region is identified by an inductance value and an inductor code (LXX). E. Select an appropriate inductor from the four manufacturer's part numbers listed in Figure 8.</p> <p>3. Output Capacitor Selection (C_{OUT}) A. In the majority of applications, low ESR electrolytic or solid tantalum capacitors between 82 μF and 820 μF provide the best results. This capacitor should be located close to the IC using short capacitor leads and short copper traces. Do not use capacitors larger than 820 μF. B. To simplify the capacitor selection procedure, refer to the quick design table shown in Figure 3. This table contains different output voltages, and lists various output capacitors that will provide the best design solutions.</p>	<p>$I_{LOAD(max)}$ = 3A F = Switching Frequency (Fixed at a nominal 150 kHz).</p> <p>1. Programming Output Voltage (Selecting R_1 and R_2, as shown in Figure 1) Select R_1 to be 1 kΩ, 1%. Solve for R_2.</p> $R_2 = R_1 \left(\frac{V_{OUT}}{V_{REF}} - 1 \right) = 1k \left(\frac{20 \text{ V}}{1.23 \text{ V}} - 1 \right)$ <p>$R_2 = 1k (16.26 - 1) = 15.26k$, closest 1% value is 15.4kΩ $R_2 = 15.4 \text{ k}\Omega$.</p> <p>2. Inductor Selection (L1) A. Calculate the inductor Volt • microsecond constant ($E \cdot T$),</p> $E \cdot T = (28 - 20 - 1.16) \cdot \frac{20 + 0.5}{28 - 1.16 + 0.5} \cdot \frac{1000}{150} (V \cdot \mu s)$ $E \cdot T = (6.84) \cdot \frac{20.5}{27.34} \cdot 6.67 (V \cdot \mu s) = 34.2 (V \cdot \mu s)$ <p>B. $E \cdot T = 34.2 (V \cdot \mu s)$ C. $I_{LOAD(max)} = 3A$ D. From the inductor value selection guide shown in Figure 7, the inductance region intersected by the 34 ($V \cdot \mu s$) horizontal line and the 3A vertical line is 47 μH, and the inductor code is L39. E. From the table in Figure 8, locate line L39, and select an inductor part number from the list of manufacturers part numbers.</p> <p>3. Output Capacitor Selection (C_{OUT}) B. From the quick design table shown in Figure 3, locate the output voltage column. From that column, locate the output voltage closest to the output voltage in your application. In this example, select the 24V line. Under the output capacitor section, select a capacitor from the list of through hole electrolytic or surface mount tantalum types from four different capacitor manufacturers. It is recommended that both the manufacturers and the manufacturers series that are listed in the table be used. In this example, through hole aluminum electrolytic capacitors from several different manufacturers are available. 220 μF/35V Panasonic HFQ Series 150 μF/35V Nichicon PL Series</p>
<p>C. The capacitor voltage rating should be at least 1.5 times greater than the output voltage, and often much higher voltage ratings are needed to satisfy the low ESR requirements needed for low output ripple voltage.</p>	<p>C. For a 20V output, a capacitor rating of at least 30V or more is needed. In this example, either a 35V or 50V capacitor would work. A 35V rating was chosen, although a 50V rating could also be used if a lower output ripple voltage is needed. Other manufacturers or other types of capacitors may also be used, provided the capacitor specifications</p>



LM2596 Simple switcher Power Converter 150kHz 3A Step-Down Voltage Regulator

PROCEDURE (Adjustable Output Voltage Version)	EXAMPLE (Adjustable Output Voltage Version)
<p>4. Feedforward Capacitor (C_{FF}) (See Figure 1) For output voltages greater than approximately 10V, an additional capacitor is required. The compensation capacitor is typically between 100 pF and 33 nF, and is wired in parallel with the output voltage setting resistor, R2. It provides additional stability for high output voltages, low input-output voltages, and/or very low ESR output capacitors, such as solid tantalum capacitors.</p> $C_{FF} = \frac{1}{31 \times 10^3 \times R_2}$ <p>This capacitor type can be ceramic, plastic, silver mica, etc. (" ecause of the unstable characteristics of ceramic capacitors made with Z5U material, they are not recommended.)</p>	<p>(especially the 100 kHz ESR) closely match the types listed in the table. Refer to the capacitor manufacturers data sheet for this information.</p> <p>4. Feedforward Capacitor (C_{FF}) The table shown in Figure 3 contains feed forward capacitor values for various output voltages. In this example, a 560 pF capacitor is needed.</p>

LM2596 SERIES BUCK REGULATOR DESING PROCEDURE (ADJUSTABLE OUTPUT)

Output Voltage (V)	Through Hole Output Capacitor			Surface Mount Output Capacitor		
	Panasonic HFQ Series (μF/V)	Nichicon PL Series (μF/V)	Feedforward capacitor	AVX TPS Series (μF/V)	Sprague 595D Series (μF/V)	Feedforward Capacitor
2	820/35	820/35	33 nF	330/6.3	470/4	33 nF
4	560/35	470/35	10 nF	330/6.3	390/6.3	10 nF
6	470/25	470/25	3.3 nF	220/10	330/10	3.3 nF
9	330/25	330/25	1.5 nF	100/16	180/16	1.5 nF
12	330/25	330/25	1 nF	100/16	180/16	1 nF
15	220/35	220/35	680 pF	68/20	120/20	680 pF
24	220/35	150/35	560 pF	33/25	33/25	220 pF
28	100/50	100/50	390 pF	10/35	15/50	220 pF

Figure 3. Output Capacitor and Feedforward Capacitor Selection Table

LM2596 SERIES BUCK REGULATOR DESIGN PROCEDURE

Inductor Value Selection Guides (For Continuous Mode Operation)

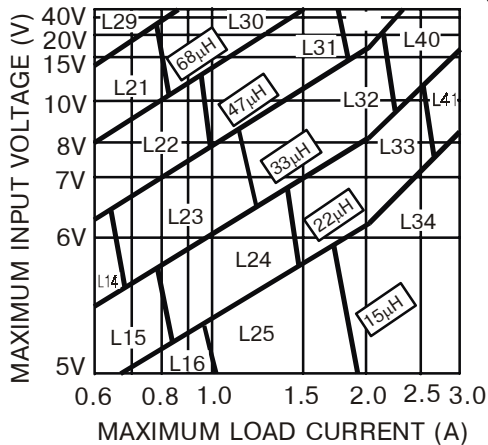

Figure 4. LM2596-3.3

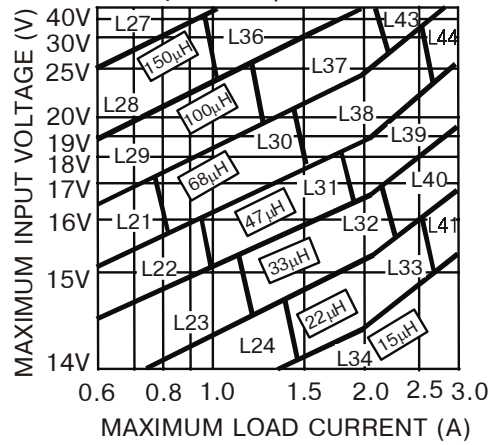
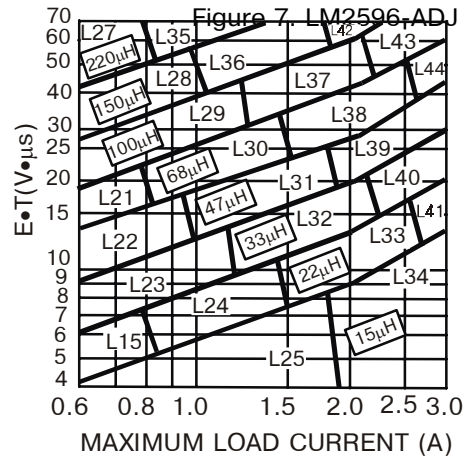
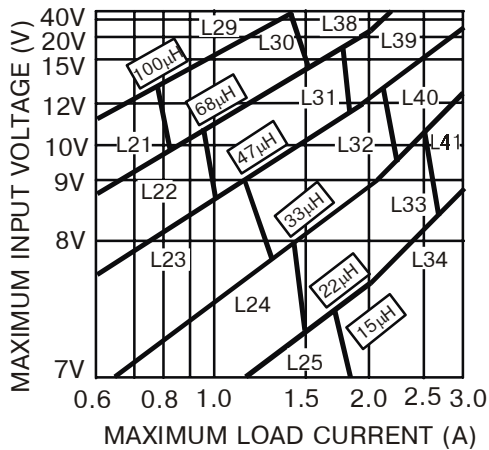

Figure 6. LM2596-12



LM2596 Simple Switcher Power Converter 150kHz 3A Step-Down Voltage Regulator



LM2596 SERIES BUCK REGULATOR DESIGN PROCEDURE (Continued)

	Inductance (μH)	Current (A)	Schott		Renco		Pulse Engineering		Coilcraft
			Through Hole	Surface Mount	Through Hole	Surface Mount	Through Hole	Surface Mount	Surface Mount
L15	22	0.99	67148350	67148460	RL-1284-22-43	RL1500-22	PE-53815	PE-53815-S	DO3308-223
L21	68	0.99	67144070	67144450	RL-5471-5	RL1500-68	PE-53821	PE-53821-S	DO3316-683
L22	47	1.17	67144080	67144460	RL-5471-6	-	PE-53822	PE-53822-S	DO3316-473
L23	33	1.40	67144090	67144470	RL-5471-7	-	PE-53823	PE-53823-S	DO3316-333
L24	22	1.70	67148370	67148480	RL-1283-22-43	-	PE-53824	PE-53825-S	DO3316-223
L25	15	2.10	67148380	67148490	RL-1283-15-43	-	PE-53825	PE-53824-S	DO3316-153
L26	330	0.80	67144100	67144480	RL-5471-1	-	PE-53826	PE-53826-S	DO5022P-334
L27	220	1.00	67144110	67144490	RL-5471-2	-	PE-53827	PE-53827-S	DO5022P-224
L28	150	1.20	67144120	67144500	RL-5471-3	-	PE-53828	PE-53828-S	DO5022P-154
L29	100	1.47	67144130	67144510	RL-5471-4	-	PE-53829	PE-53829-S	DO5022P-104
L30	68	1.78	67144140	67144520	RL-5471-5	-	PE-53830	PE-53830-S	DO5022P-683
L31	47	2.20	67144150	67144530	RL-5471-6	-	PE-53831	PE-53831-S	DO5022P-473
L32	33	2.50	67144160	67144540	RL-5471-7	-	PE-53932	PE-53932-S	DO5022P-333
L33	22	3.10	67148390	67148500	RL-1283-22-43	-	PE-53933	PE-53933-S	DO5022P-223
L34	15	3.40	67148400	67148790	RL-1283-15-43	-	PE-53934	PE-53934-S	DO5022P-153
L35	220	1.70	67144170	-	RL-5473-1	-	PE-53935	PE-53935-S	-
L36	150	2.10	67144180	-	RL-5473-4	-	PE-54036	PE-54036-S	-
L37	100	2.50	67144190	-	RL-5472-1	-	PE-54037	PE-54037-S	-
L38	68	3.10	67144200	-	RL-5472-2	-	PE-54038	PE-54038-S	-
L39	47	3.50	67144210	-	RL-5472-3	-	PE-54039	PE-54039-S	-
L40	33	3.50	67144220	67148290	RL-5472-4	-	PE-54040	PE-54040-S	-
L41	22	3.50	67144230	67148300	RL-5472-5	-	PE-54041	PE-54041-S	-
L42	150	2.70	67148410	-	RL-5473-4	-	PE-54042	PE-54042-S	-
L43	100	3.40	67144240	-	RL-5473-2	-	PE-54043	-	-
L44	68	3.40	67144250	-	RL-5473-3	-	PE-54044	-	-

Figure 8. Inductor Manufacturers Part Numbers

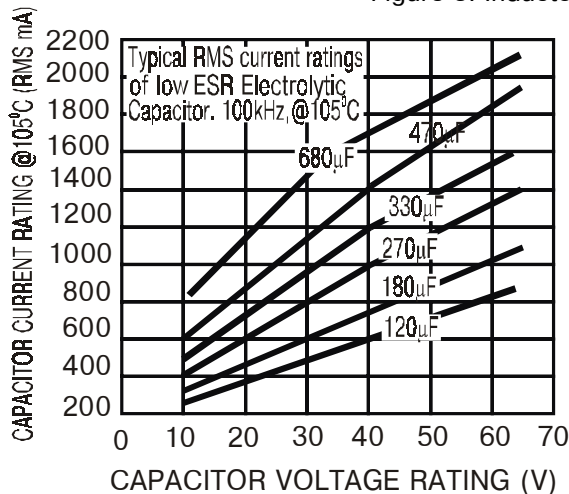
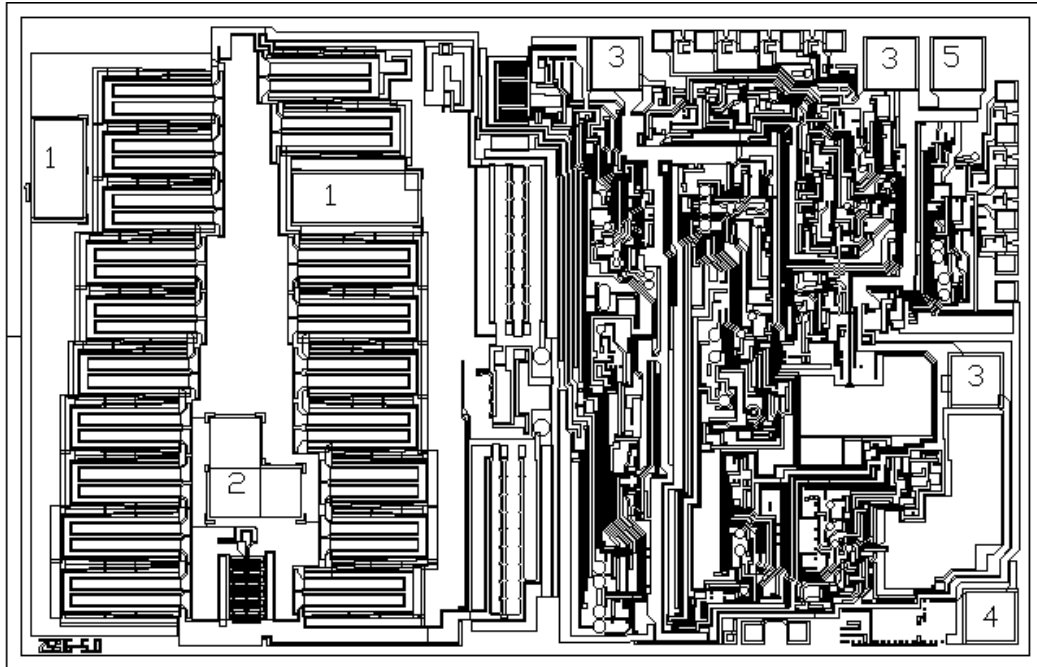

Figure 9. RMS Current Ratings for Low ESR Electrolytic Capacitors (typical)



LM2596 Simple switcher Power Converter 150kHz 3A Step-Down Voltage Regulator

PAD DIAGRAM



Chip Size 4.2 x 2.7 mm²

PAD LOCATIONS COORDINATES

Pad N	Pad Name	Pad Size μm	Coordinates μm	
			X	Y
1	V _{IN}	200 x 400	210	2023
1	V _{IN}	505 x 205	1412	1911
2	Out	205 x 400	925	720
3	GND	200 x 200	2461	2454
3	GND	200 x 200	3578	2454
3	GND	200 x 200	3921	1174
4	F"	200 x 200	3980	220
5	ON/OFF	200 x 200	3848	2454



LM2596 Simple switcher Power Converter 150kHz 3A Step-Down Voltage Regulator

PACKAGE DIMENSIONS

TO-220-5L

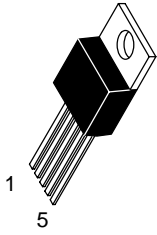

- Pin 1. V_{in}
 2. Output
 3. Ground
 4. Feedback
 5. ON

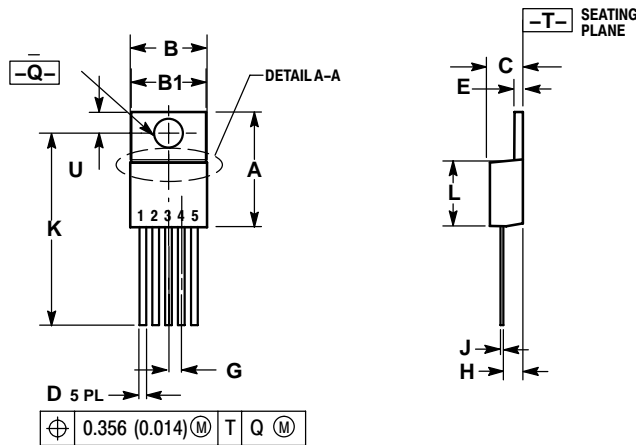
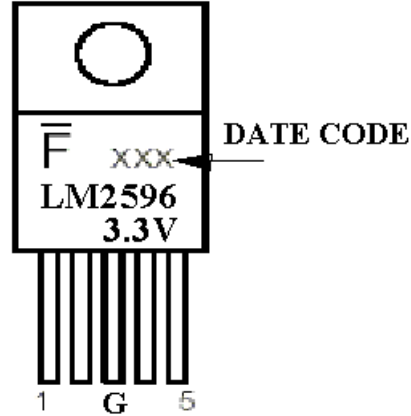

DIM	INCHES		MILLIMETERS	
	MIN	MAX	MIN	MAX
A	0.572	0.613	14.529	15.570
B	0.390	0.415	9.906	10.541
B1	0.375	0.415	9.525	10.541
C	0.170	0.180	4.318	4.572
D	0.025	0.038	0.635	0.965
E	0.048	0.055	1.219	1.397
G	0.067 BSC		1.702 BSC	
H	0.087	0.112	2.210	2.845
J	0.015	0.025	0.381	0.635
K	0.977	1.045	24.810	26.543
L	0.320	0.365	8.128	9.271
Q	0.140	0.153	3.556	3.886
U	0.105	0.117	2.667	2.972

TO-263-5L(D2PAK)

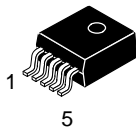

- Pin 1. V_{in}
 2. Output
 3. Ground
 4. Feedback
 5. ON

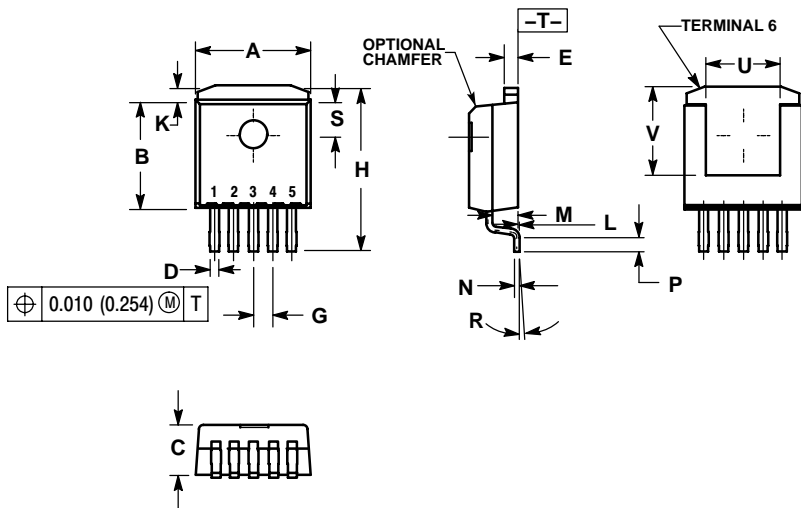
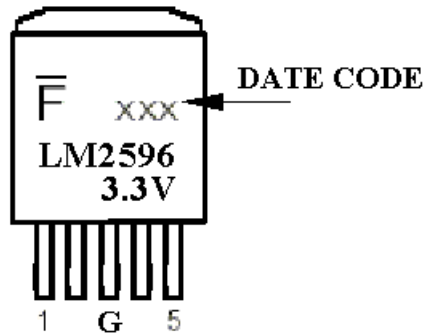

DIM	INCHES		MILLIMETERS	
	MIN	MAX	MIN	MAX
A	0.386	0.403	9.804	10.236
B	0.356	0.368	9.042	9.347
C	0.170	0.180	4.318	4.572
D	0.026	0.036	0.660	0.914
E	0.045	0.055	1.143	1.397
G	0.067 BSC		1.702 BSC	
H	0.539	0.579	13.691	14.707
K	0.050 REF		1.270 REF	
L	0.000	0.010	0.000	0.254
M	0.088	0.102	2.235	2.591
N	0.018	0.026	0.457	0.660
P	0.058	0.078	1.473	1.981
R	5° REF		5° REF	
S	0.116 REF		2.946 REF	
U	0.200 MIN		5.080 MIN	
V	0.250 MIN		6.350 MIN	