

Primary-side-control PWM Controller

SGP100

FEATURES

- Constant-voltage (CV) and constant-current (CC) control without secondary-feedback circuitry
- Green-mode function: PWM frequency linearly decreasing
- Fixed PWM frequency at 42kHz with frequency hopping to solve EMI problems
- Low start-up current: 10μA (typical)
- Low operating current: 6.5mA (typical)
- Peak-current-mode control in CV mode
- Cycle-by-cycle current limiting
- V_{DD} over-voltage protection with latch (OVP)
- V_{DD} under-voltage lockout (UVLO)
- Gate output maximum voltage clamped at 18V
- Fixed over-temperature protection with latch

APPLICATIONS

- Battery chargers for cellular phones, cordless phones, PDA, digital cameras, and power tools
- Replacement for linear transformer and RCC SMPS

DESCRIPTION

This highly integrated PWM controller provides several features to enhance the performance of low-power flyback converters. The patented topology of SGP100 enables simplified circuit design for battery charger

applications. The result is a low-cost, smaller and lighter charger than a conventional design or a linear transformer.

To minimize the standby power consumption, the proprietary green-mode function provides off-time modulation to linearly decrease PWM frequency under light-load conditions. This green-mode function allows the power supply to meet power conservation requirements. The start-up current is only 10μA, which allows large start-up resistance for further power saving.

A charger can be implemented with few external components and minimal cost. A typical output CV/CC characteristic envelope is shown in Figure 1.

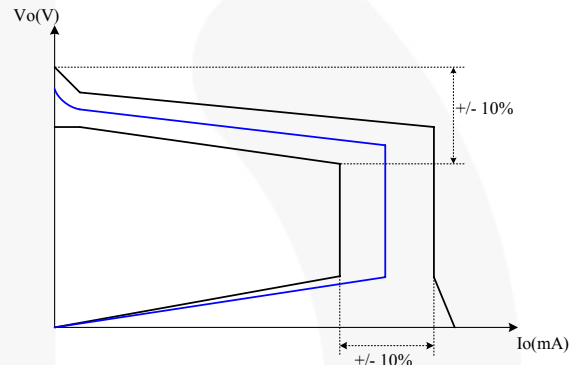
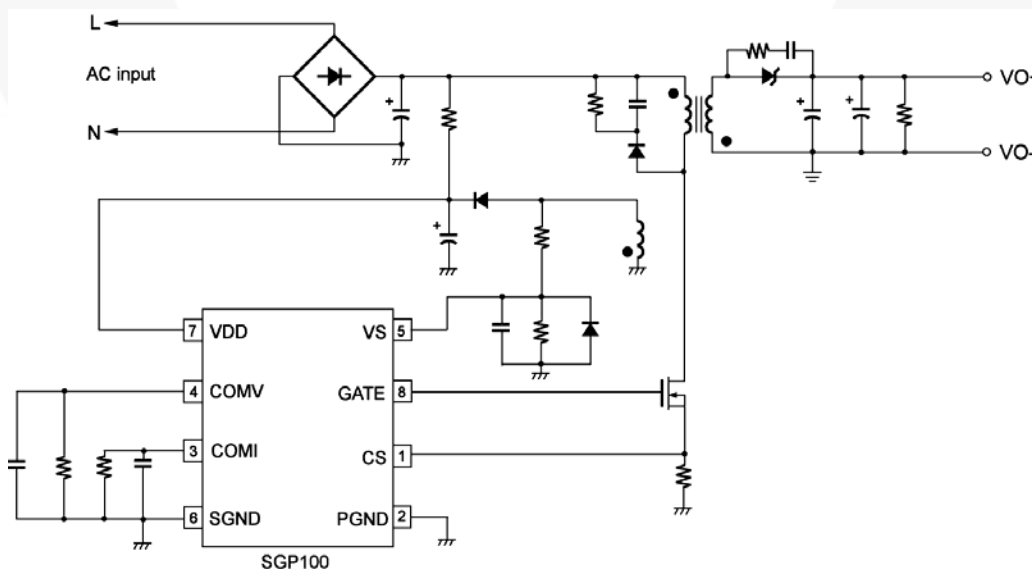

Figure 1. Typical Output V-I Characteristic

TYPICAL APPLICATION



MARKING INFORMATION

PIN CONFIGURATION

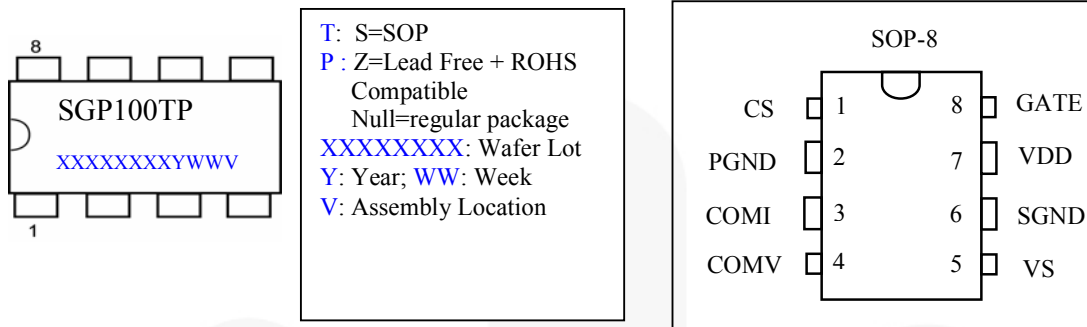

ORDERING INFORMATION

Part Number	Pb-Free	Package
SGP100SZ		8-pin SOP-8

PIN DESCRIPTIONS

Name	Pin No.	Type	Function
CS	1	Analog Input	Current sense. Connected to a current-sense resistor for peak-current-mode control in CV mode. The current-sense signal is also provided for output-current regulation in CC mode.
PGND	2	Ground	Power ground.
COMI	3	Analog Output	Current compensation. Output of the current error amplifier. Connect a capacitor between the COMI pin and SGND for frequency compensation.
COMV	4	Analog Output	Voltage compensation. Output of the voltage error amplifier. Connect a capacitor between the COMV pin and SGND for frequency compensation.
VS	5	Analog Input	Voltage sense. Output-voltage-sense input for output-voltage regulation.
SGND	6	Ground	Signal ground.
VDD	7	Supply	Power supply.
GATE	8	Driver Output	The totem-pole output driver to drive the power MOSFET.

BLOCK DIAGRAM

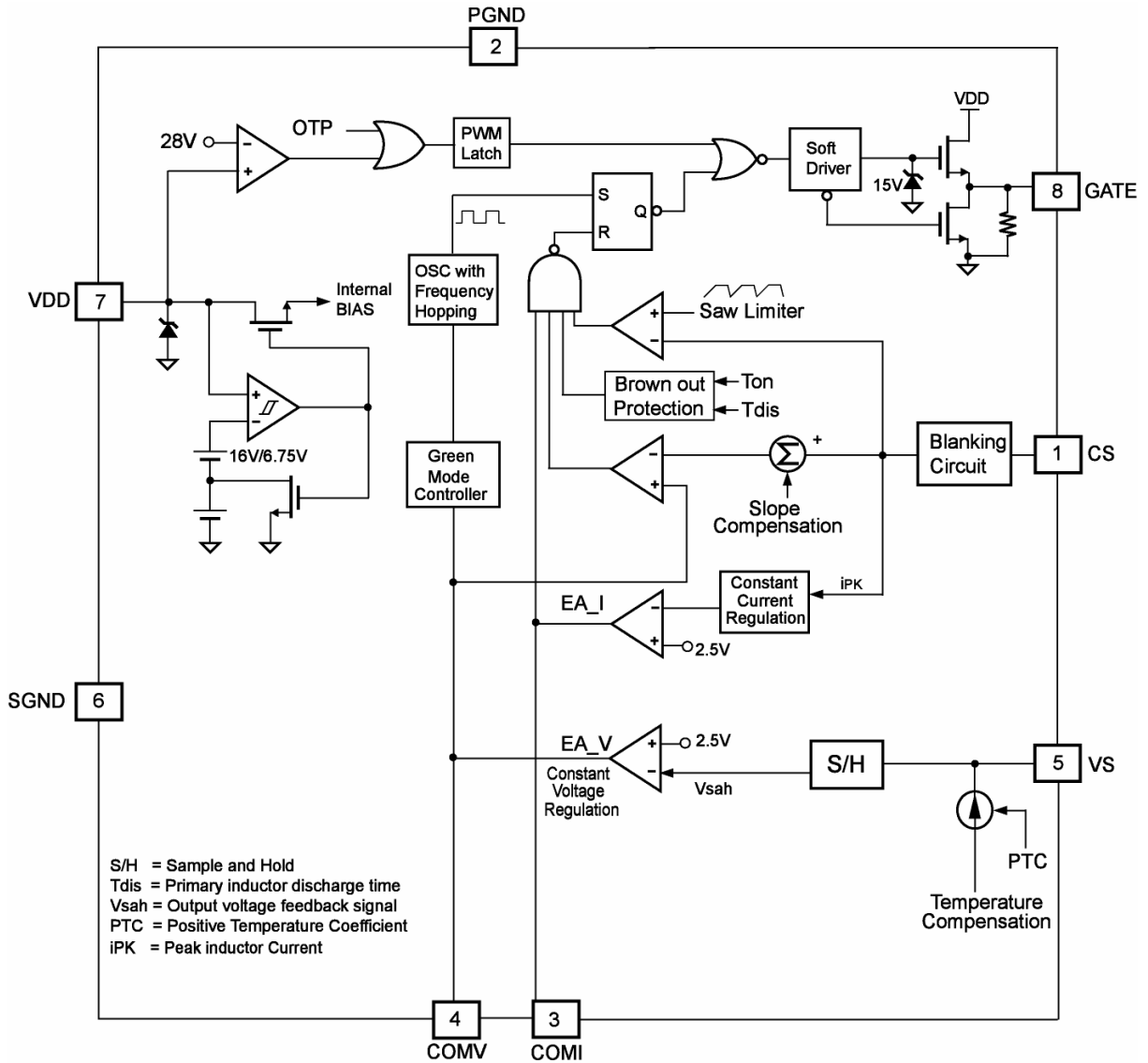

Primary-side-control PWM Controller

SGP100

ABSOLUTE MAXIMUM RATINGS

Symbol	Parameter	Value	Unit
V _{DD}	DC Supply Voltage*	30	V
V _L	Input Voltage to CS, COMV, COMI, VS Pins	-0.3 to 7.0	V
P _D	Power Dissipation	400	mW
R _{θJC}	Thermal Resistance (Junction-to-Case)	68.3	°C/W
T _J	Operating Junction Temperature	-40 to +125	°C
T _{STG}	Storage Temperature Range	-55 to +150	°C
T _L	Lead Temperature (Wave Soldering or Infrared, 10 Seconds)	260	°C
ESD	Electrostatic Discharge Capability, Human Body Model	4.5	kV
	Electrostatic Discharge Capability, Machine Model	200	V

*All voltage values, except differential voltages, are given with respect to the GND pin.

*Stresses beyond those listed under "absolute maximum ratings" may cause permanent damage to the device.

RECOMMENDED OPERATING CONDITIONS

Symbol	Parameter	Max.	Unit
T _A	Operating Ambient Temperature	-20 to +85	°C

*For proper operation.

ELECTRICAL CHARACTERISTICS

V_{CC}=15V, T_A=25°C, unless otherwise noted.

V_{DD} Section

Symbol	Parameter	Test Condition	Min.	Typ.	Max.	Unit
V _{OP}	Continuously Operating Voltage				25	V
V _{DD-ON}	Turn-on Threshold Voltage		15	16	17	V
V _{DD-OFF}	Turn-off Threshold Voltage		6.25	6.75	7.25	V
I _{DD-ST}	Start-up Current	0 < V _{DD} < V _{DD-ON} -0.16V		10	20	μA
I _{DD-OP}	Operating Supply Current	V _{DD} =20V, F _S =F _{OSC} , C _L =1nF		6.5	7.5	mA
V _{DD-OVP}	V _{DD} Over-Voltage Protection Level		27	28	29	V
T _{OVP}	V _{DD} Over-Voltage Protection Debounce	F _S =F _{OSC}	90	130	180	μs
I _{DD-OVP}	V _{DD} Over-Voltage Protection Holding Current	V _{DD} =5V	10	30	50	μA

Oscillator Section

Symbol	Parameter	Test Condition	Min.	Typ.	Max.	Unit
F _{OSC}	Frequency	Center frequency	39	42	45	kHz
		Frequency Hopping Range	±2.2	±2.6	±3	
T _{FHP}	Frequency Hopping Period		2.75	3.00	3.25	ms
F _{OSC-N-MIN}	Minimum Frequency at No-load		350	500	650	Hz
F _{OSC-CM-MIN}	Minimum Frequency at CCM		20	25	35	kHz

Primary-side-control PWM Controller

SGP100

Voltage-Sense Section

Symbol	Parameter	Test Condition	Min.	Typ.	Max.	Unit
T _{RATIO}	Proportion of T _{ON} and T _{DIS} for Brownout Protection*	T _{ON} /T _{DIS}		1.5		
I _{TC-25}	CV Temperature Compensation Current		9	10	11	μA

* Guaranteed by design.

Current-Sense Section

Symbol	Parameter	Test Condition	Min.	Typ.	Max.	Unit
Z _{CS}	Filter Resistance			2		kΩ
T _{PD}	Propagation Delay to GATE Output			150	200	ns
T _{LEB}	Leading-Edge Blanking Time	T _{MIN-N} -T _{PD}	825	1025	1225	ns
T _{MIN-N}	Minimum On-time at No Load		1075	1200	1350	ns
V _{SLOPE}	Slope Compensation*		0.37	0.40	0.43	V
D _{SAW}	Duty Cycle of SAW Limiter*		35	40	45	%
V _{TH-VA}	Valley Threshold Voltage for Current Limit		V _{TH-FT} - 0.4	V _{TH-FT} - 0.25	V _{TH-FT} - 0.1	V
V _{TH-FT}	Flat threshold Voltage for Current Limit		1.2	1.3	1.5	V

* Guaranteed by design.

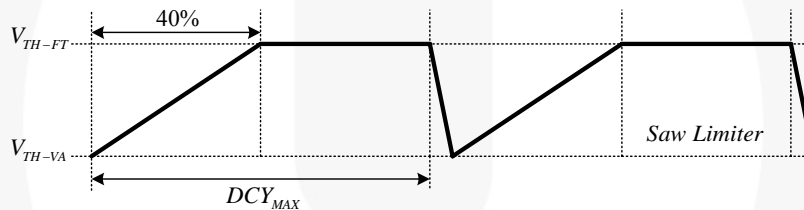

Voltage Error Amplifier Section

Symbol	Parameter	Test Condition	Min.	Typ.	Max.	Unit
V _{VR}	Reference Voltage		2.475	2.500	2.525	V
V _N	Green-Mode Starting Voltage	F _S =F _{OSC} -2KHz	1.55	1.70	1.85	V
V _G	Green-Mode Ending Voltage	F _S =1KHz		0.55	0.90	V
S _G	Green-Mode Frequency Decreasing Rate	S _G =(F _{OSC} -3KHz)/(V _N -V _G)	25	35	45	Hz/mV
I _{V-SINK}	Output Sink Current	V _{VS} =3V, V _{COMV} =2.5V	85	100	115	μA
I _{V-SOURCE}	Output Source Current	V _{VS} =2V, V _{COMV} =2.5V	85	100	115	μA
V _{V-HIGH}	Output High Voltage	V _{VS} =2.3V	4.5			V

Current Error Amplifier Section

Symbol	Parameter	Test Condition	Min.	Typ.	Max.	Unit
V _{IR}	Reference Voltage		2.475	2.500	2.525	V
I _{I-SINK}	Output Sink Current	V _{CS} =3V, V _{COMI} =2.5V	40	60	80	μA
I _{I-SOURCE}	Output Source Current	V _{CS} =0.5V, V _{COMI} =2.5V	40	60	80	μA
V _{I-HIGH}	Output High Voltage	V _{CS} =0.5V	4.5			V

Primary-side-control PWM Controller

SGP100

GATE Section

Symbol	Parameter	Test Condition	Min.	Typ.	Max.	Unit
DCY _{MAX}	Maximum Duty Cycle		70	75	80	%
V _{OL}	Output Voltage Low	V _{DD} =20V, I _O =10mA			1.5	V
V _{OH}	Output Voltage High	V _{DD} =8V, I _O =1mA	5			V
T _R	Rising Time	V _{DD} =20V, C _L =1nF		200		ns
T _F	Falling Time	V _{DD} =20V, C _L =1nF		80		ns
V _{CLAMP}	Output Clamp Voltage	V _{DD} =25V		15	18	V

Over-Temperature Protection Section

Symbol	Parameter	Test Condition	Min.	Typ.	Max.	Unit
T _{OTP}	Threshold Temperature for OTP ⁺		135	150	165	°C

* Guaranteed by design.

⁺ When the over-temperature protection is activated, the power system enters latch mode and output is disabled.

TYPICAL CHARACTERISTICS

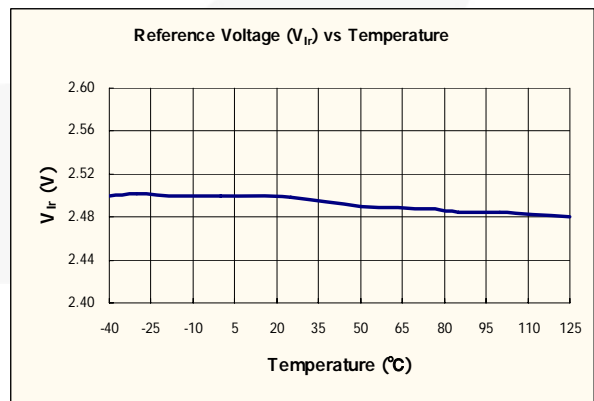
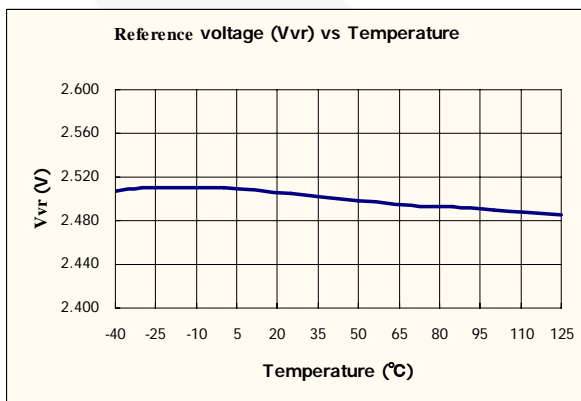
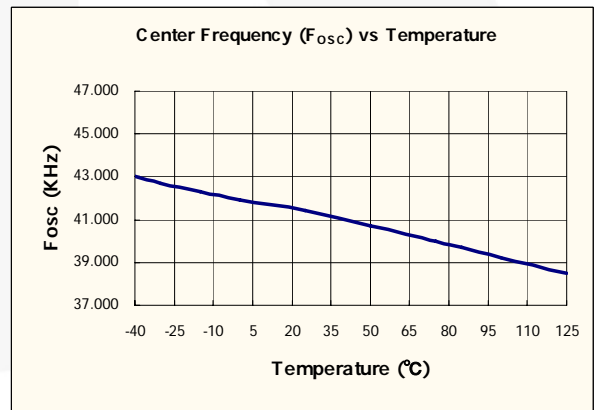
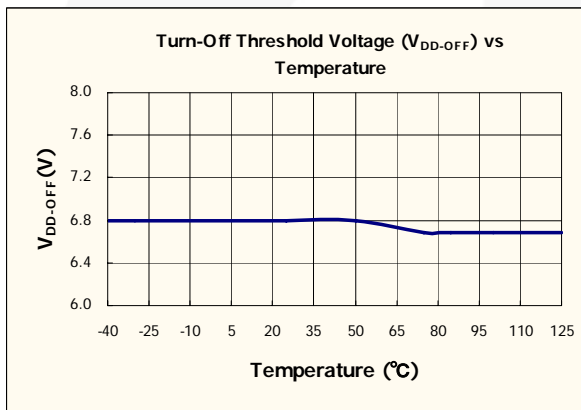
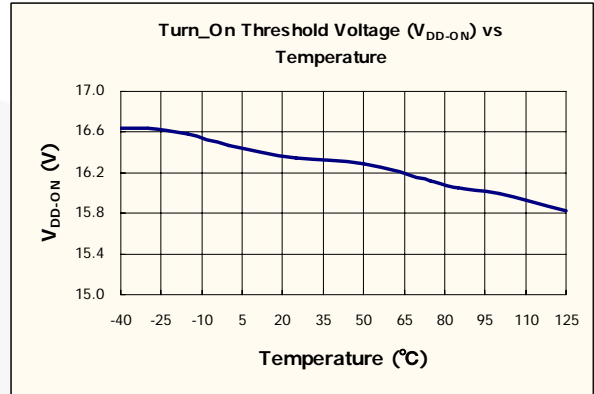
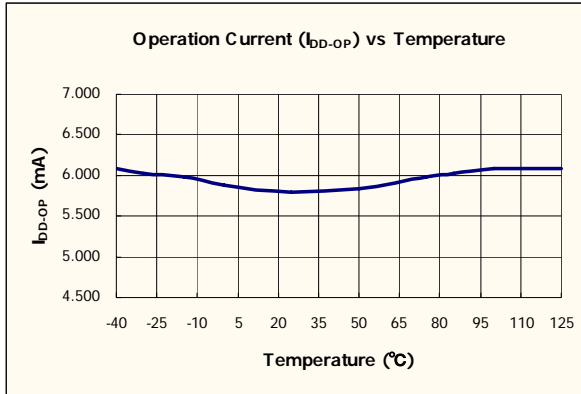

Primary-side-control PWM Controller

SGP100

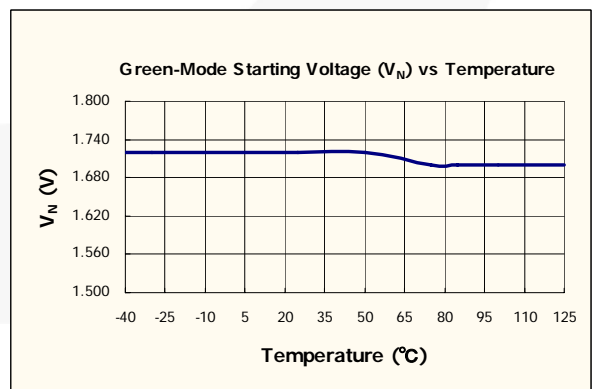
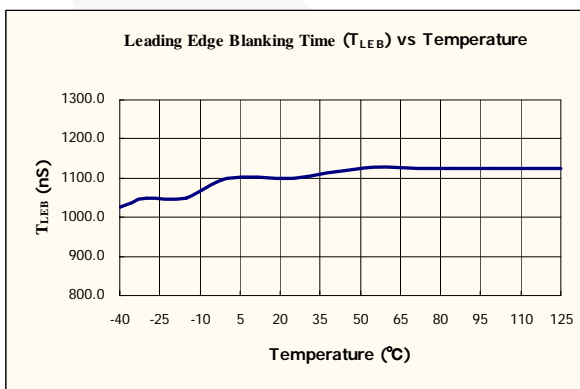
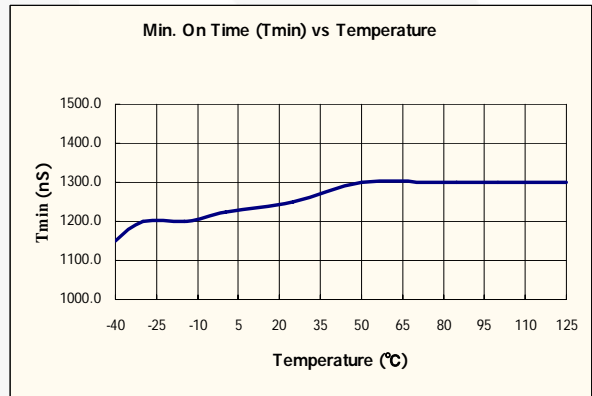
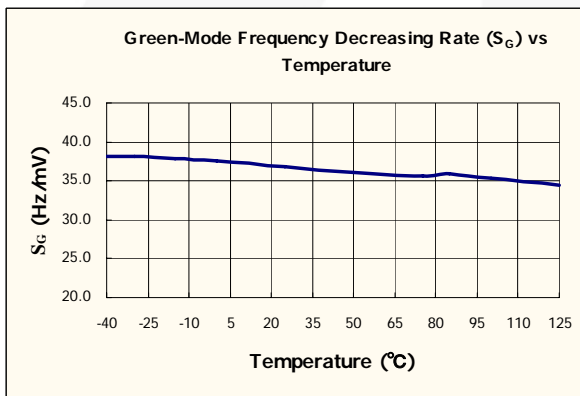
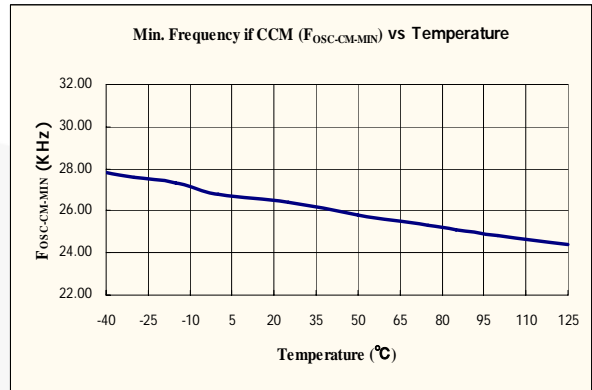
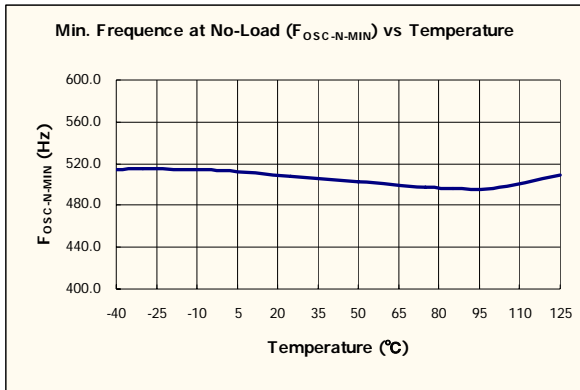

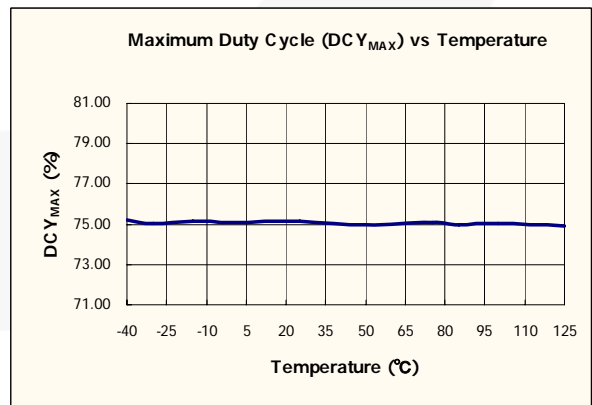
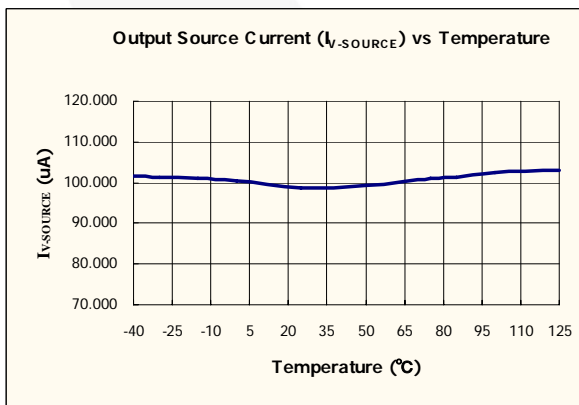
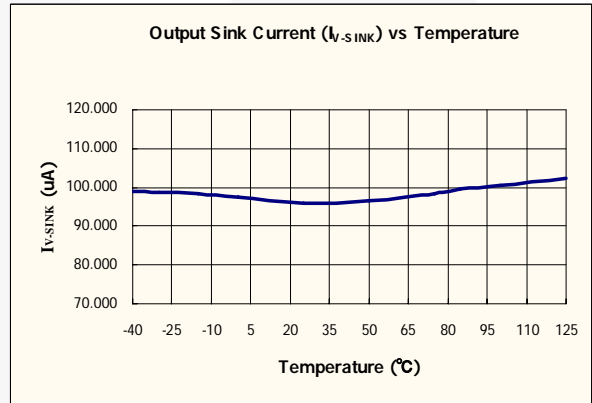
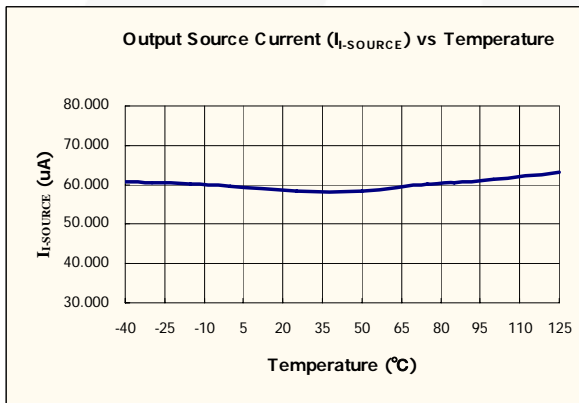
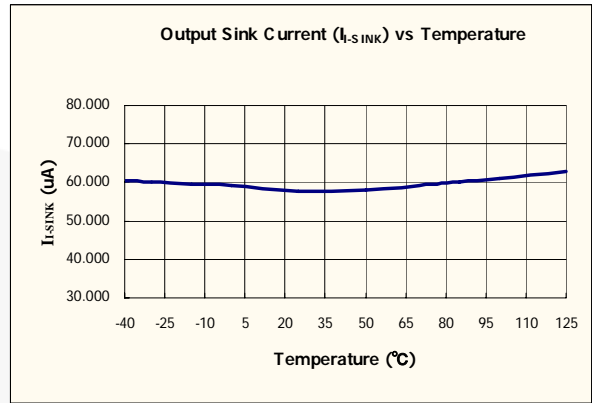
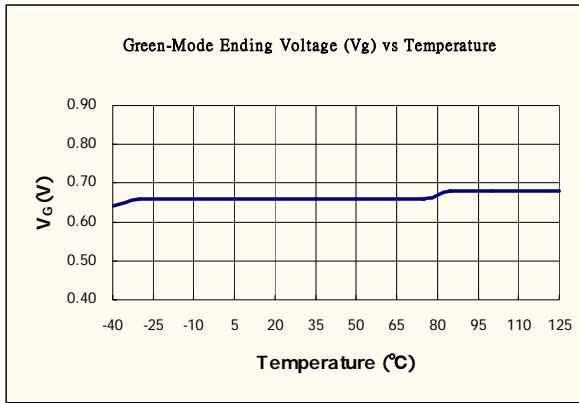

OPERATION DESCRIPTION

The patented topology of SGP100 enables simplified circuit design for battery charger applications. Without secondary feedback circuitry, the CV and CC control can be achieved accurately. As shown in Figure 2, with the frequency-hopping PWM operation, EMI problem can be solved using minimized filter components. SGP100 also provides many protection functions. The VDD pin is equipped with over-voltage protection and under-voltage lockout. Pulse-by-pulse current limiting and CC control ensure over-current protection at heavy loads. The GATE output is clamped at 18V to protect the external MOSFET from over-voltage damage. Also, the internal over-temperature protection shuts down the controller with latch when over heated.

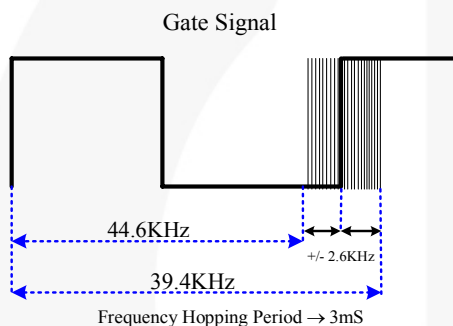

Figure 2. Frequency Hopping

Start-up Current

The start-up current is only 10μA. Low start-up current allows a start-up resistor with high resistance and low-wattage to supply the start-up power for the controller. A 1.5MΩ, 0.25W start-up resistor and a 10μF/25V V_{DD} hold-up capacitor are sufficient for an AC-to-DC power adapter with a wide input range (90V_{AC} to 264V_{AC}).

Operating Current

The operating current has been reduced to 6.5mA. The low operating current results in higher efficiency and reduces the V_{DD} hold-up capacitance requirement.

Green-Mode Operation

Figure 3 shows the characteristics of the PWM frequency vs. the output voltage of the error amplifier (V_{COMV}). The

SGP100 uses the positive, proportional, output load parameter (V_{COMV}) as an indication of the output load for modulating the PWM frequency. In heavy load conditions, the PWM frequency is fixed at 42KHz. Once V_{COMV} is lower than V_N, the PWM frequency starts to linearly decrease from 42KHz to 500Hz (0.55V), providing further power savings and meeting international power conservation requirements.

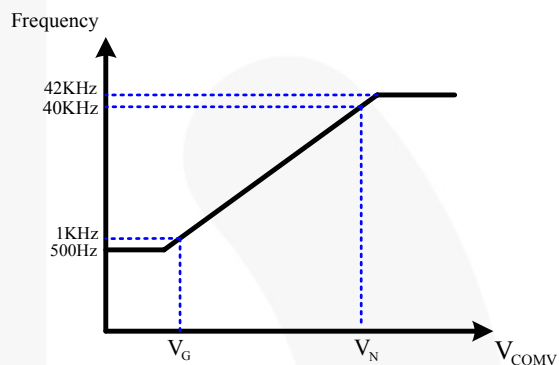

Figure 3. Green-Mode Operation Frequency vs. V_{COMV}

Constant Voltage (CV) and Constant Current (CC) Operation

An innovative technique of the SGP100 can accurately achieve CV/CC characteristic output without secondary side voltage or current-feedback circuitry. There is a feedback signal for CV/CC operation from the reflected voltage across the primary auxiliary winding. This voltage signal is proportional to secondary winding, so it provides controller the feedback signal from secondary side and achieves constant-voltage output. In constant-current output, this voltage signal is detected and examined by the precise constant current regulation controller, which determines the on-time of the MOSFET to control input power and provide constant-current output. With feedback voltage V_{CS} across the current-sense resistor, the controller can obtain the input power of power supply. Therefore, the region of constant current output operation can be adjusted by a current-sense resistor.

Temperature Compensation

The SGP100 has built-in temperature compensation circuitry to provide constant reliable voltage regulation at differing ambient temperatures. This internal positive temperature coefficient (PTC) compensation current is used to compensate for the temperature due to the forward-voltage drop of the diode output. The internal PTC current passes through the external resistor (R_1). The value of R_1 determines the temperature compensation amount. The suggested value for R_1 is 10~20K Ω with a +/-1% tolerance value.

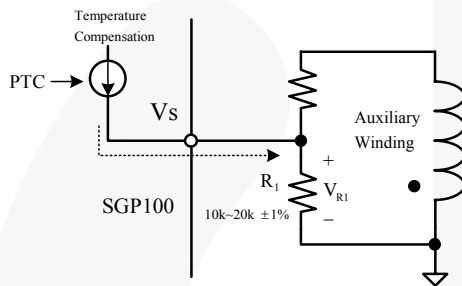

Figure 4. Temperature Compensation

Leading-Edge Blanking

Each time the power MOSFET is switched on, a turn-on spike occurs at the sense resistor. To avoid premature termination of the switching pulse, a 150ns leading-edge blanking time is built in. Conventional RC filtering can therefore be omitted. During this blanking period, the current-limit comparator is disabled and cannot switch off the gate driver.

Under-Voltage Lockout (UVLO)

The turn-on and turn-off thresholds are fixed internally at 16V/6.75V. During start-up, the hold-up capacitor must be charged to 16V through the start-up resistor, so that the SGP100 is enabled. The hold-up capacitor continues to supply V_{DD} until power can be delivered from the auxiliary winding of the main transformer. V_{DD} must not drop below 6.75V during this start-up process. This UVLO hysteresis window ensures that hold-up capacitor is adequate to supply V_{DD} during start-up.

V_{DD} Over-Voltage Protection

V_{DD} over-voltage protection prevents damage due to over-voltage conditions. When the voltage V_{DD} exceeds 28V due to abnormal conditions, PWM output is latched off. Over-voltage conditions are usually caused by open feedback loops.

Over-Temperature Protection (OTP)

The SGP100 has a built-in temperature sensing circuit to shut down the PWM output then enters latch mode once the junction temperature exceeds 150°C. When the PWM output shuts down, the V_{DD} voltage gradually drops to the UVLO voltage. The PWM controller does not release latch mode until the AC is unplugged.

Gate Output

The SGP100 BiCMOS output stage is a fast totem pole gate driver. Cross conduction is avoided to minimize heat dissipation, increase efficiency, and enhance reliability. The output driver is clamped by an internal 18V Zener diode to protect power MOSFET transistors from undesired over-voltage gate signals.

Built-in Slope Compensation

The sensed voltage across the current-sense resistor is used for current mode control and pulse-by-pulse current limiting. Built-in slope compensation improves stability and prevent sub-harmonic oscillations due to peak-current mode control. The SGP100 has a synchronized, positively-sloped ramp built-in at each switching cycle.

Noise Immunity

Noise from the current sense or the control signal can cause significant pulse width jitter. While slope compensation helps alleviate these problems, further precautions should still be taken. Good placement and layout practices should be followed. Avoiding long PCB traces and component leads, locating compensation and filter components near the SGP100, and increasing the power MOS gate resistance improves performance.

REFERENCE CIRCUIT
5W Flyback 5V/1A Circuit

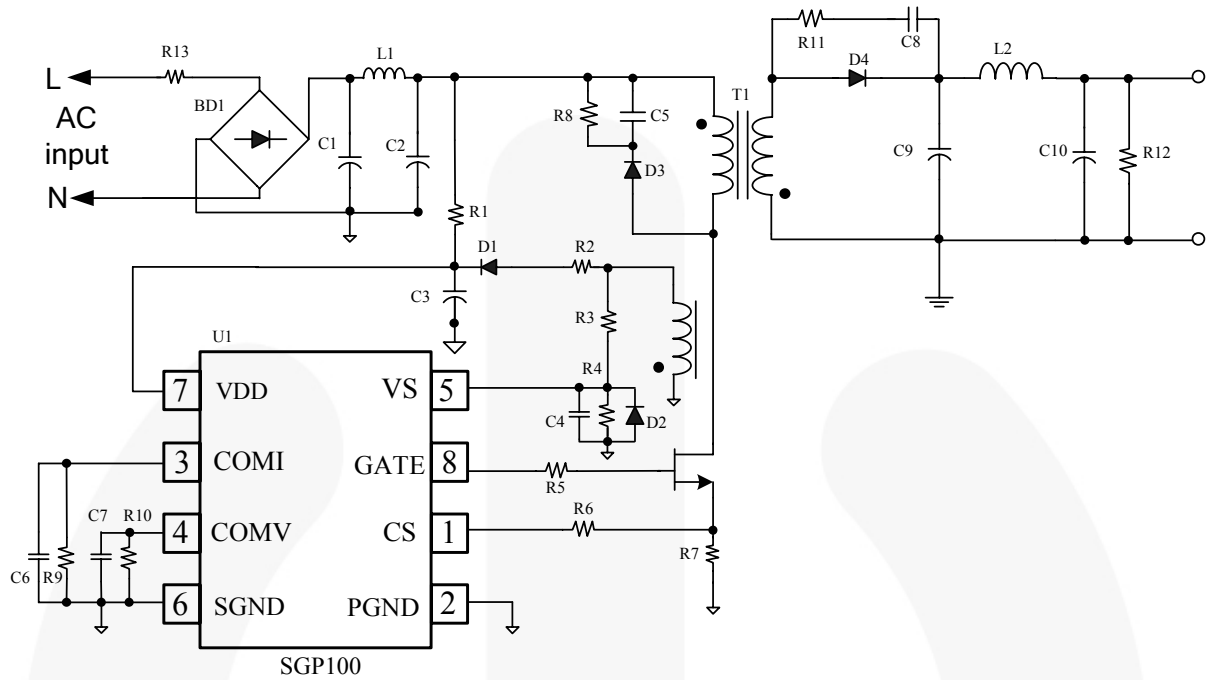

BOM List

Symbol	Component	Symbol	Component	Symbol	Component
R1	Resistor 1.5MΩ 1/2 W	D3	Diode 1A/1000V FR107	TR1	EE-16 Lm=1.5mH Pri:Sec:Aux=135:10:33
R2	Resistor 4.7Ω	D4	Diode 5A/60V SB560		
R3	Resistor 115KΩ 1%	C1	Electrolytic Capacitor 1μF/400V		
R4	Resistor 18KΩ 1%	C2	Electrolytic Capacitor 10μF/400V		
R5	Resistor 47Ω	C3	Electrolytic Capacitor 10μF/50V		
R6	Resistor 100Ω	C4	MLCC X7R 47pF		
R7	Resistor 1.4Ω 1/2W 1%	C5	Snubber Cap. 222pF/1KV		
R8	Resistor 150KΩ 1/2W	C6	MLCC X7R 683pF		
R9	Resistor 200KΩ	C7	MLCC X7R 103pF		
R10	Resistor 56KΩ	C8	MLCC 102pF/100V		
R11	Resistor 47Ω	C9	Electrolytic Cap. 560μF/10V L-ESR		
R12	Resistor 510Ω	C10	Electrolytic Cap. 330μF/10V L-ESR		
R13	WireWound Resistor 18Ω	L1	Inductor 1mH		
BD1	Rectifier Diode 1N4007 *4	L2	Inductor 5μH		
D1	Diode 1A/200V FR103	Q1	Fairchild 2A/600V 2N60 TO-251		
D2	Diode 1N4148	U1	SGP100		

PACKAGE INFORMATION

8PINS-SOP(S)

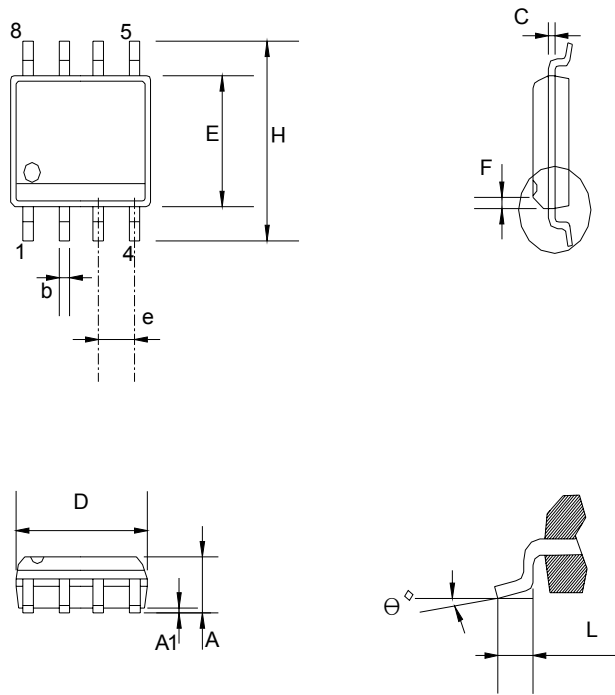

DIMENSIONS

Symbol	Millimeter			Inch		
	Min.	Typ.	Max.	Min.	Typ.	Max.
A	1.346		1.752	0.053		0.069
A1	0.101		0.254	0.004		0.010
b		0.406			0.016	
c		0.203			0.008	
D	4.648		4.978	0.183		0.196
E	3.810		3.987	0.150		0.157
e	1.016	1.270	1.524	0.040	0.050	0.060
F		0.381X45°			0.015X45°	
H	5.791		6.197	0.228		0.244
L	0.406		1.270	0.016		0.050
θ°	0°		8°	0°		8°

Primary-side-control PWM Controller

SGP100



TRADEMARKS

The following are registered and unregistered trademarks and service marks Fairchild Semiconductor owns or is authorized to use and is not intended to be an exhaustive list of all such trademarks.

- | | | | |
|--------------------------------------|---|--|----------------------------------|
| ACEX [®] | Green FPS [™] | Power247 [®] | SuperSOT [™] -8 |
| Build it Now [™] | Green FPS [™] e-Series [™] | POWEREDGE [®] | SyncFET [™] |
| CorePLUS [™] | GTO [™] | Power-SPM [™] | The Power Franchise [®] |
| CROSSVOL [™] | i-Lo [™] | PowerTrench [®] | the power franchise |
| CTL [™] | IntelliMAX [™] | Programmable Active Droop [™] | TinyBoost [™] |
| Current Transfer Logic [™] | ISOPLANAR [™] | QFET [®] | TinyBuck [™] |
| EcoSPARK [®] | MegaBuck [™] | QS [™] | TinyLogic [®] |
| F [®] | MICROCOUPLER [™] | QT Optoelectronics [™] | TINYOPTO [™] |
| Fairchild [®] | MicroFET [™] | Quiet Series [™] | TinyPower [™] |
| Fairchild Semiconductor [®] | MicroPak [™] | RapidConfigure [™] | TinyPWM [™] |
| FACT Quiet Series [™] | MillerDrive [™] | SMART START [™] | TinyWire [™] |
| FACT [®] | Motion-SPM [™] | SPM [®] | μSerDes [™] |
| FAST [®] | OPTOLOGIC [®] | STEALTH [™] | UHC [®] |
| FastvCore [™] | OPTOPLANAR [®] | SuperFET [™] | UniFET [™] |
| FPS [™] |  [®] | SuperSOT [™] -3 | Vcx [™] |
| FRFET [®] | PDP-SPM [™] | SuperSOT [™] -6 | |
| Global Power Resource SM | Power220 [®] | | |

DISCLAIMER

FAIRCHILD SEMICONDUCTOR RESERVES THE RIGHT TO MAKE CHANGES WITHOUT FURTHER NOTICE TO ANY PRODUCTS HEREIN TO IMPROVE RELIABILITY, FUNCTION, OR DESIGN. FAIRCHILD DOES NOT ASSUME ANY LIABILITY ARISING OUT OF THE APPLICATION OR USE OF ANY PRODUCT OR CIRCUIT DESCRIBED HEREIN; NEITHER DOES IT CONVEY ANY LICENSE UNDER ITS PATENT RIGHTS, NOR THE RIGHTS OF OTHERS. THESE SPECIFICATIONS DO NOT EXPAND THE TERMS OF FAIRCHILD'S WORLDWIDE TERMS AND CONDITIONS, SPECIFICALLY THE WARRANTY THEREIN, WHICH COVERS THESE PRODUCTS.

LIFE SUPPORT POLICY

FAIRCHILD'S PRODUCTS ARE NOT AUTHORIZED FOR USE AS CRITICAL COMPONENTS IN LIFE SUPPORT DEVICES OR SYSTEMS WITHOUT THE EXPRESS WRITTEN APPROVAL OF FAIRCHILD SEMICONDUCTOR CORPORATION.

As used herein:

1. Life support devices or systems are devices or systems which, (a) are intended for surgical implant into the body or (b) support or sustain life, and (c) whose failure to perform when properly used in accordance with instructions for use provided in the labeling, can be reasonably expected to result in a significant injury of the user.
2. A critical component in any component of a life support, device, or system whose failure to perform can be reasonably expected to cause the failure of the life support device or system, or to affect its safety or effectiveness.

PRODUCT STATUS DEFINITIONS

Definition of Terms

Datasheet Identification	Product Status	Definition
Advance Information	Formative or In Design	This datasheet contains the design specifications for product development. Specifications may change in any manner without notice.
Preliminary	First Production	This datasheet contains preliminary data; supplementary data will be published at a later date. Fairchild Semiconductor reserves the right to make changes at any time without notice to improve design.
No Identification Needed	Full Production	This datasheet contains final specifications. Fairchild Semiconductor reserves the right to make changes at any time without notice to improve design.
Obsolete	Not In Production	This datasheet contains specifications on a product that has been discontinued by Fairchild Semiconductor. The datasheet is printed for reference information only.

Rev. I31