

ISOTOP[®] Buck chopper Super Junction MOSFET Power Module

$V_{DSS} = 900V$
 $R_{DSon} = 120m\Omega \text{ max @ } T_j = 25^\circ C$
 $I_D = 33A \text{ @ } T_c = 25^\circ C$

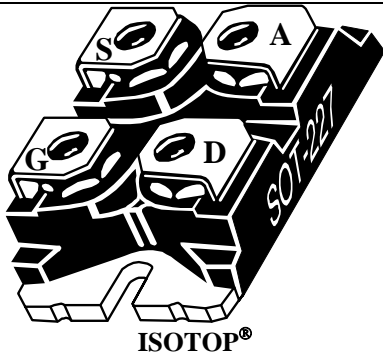
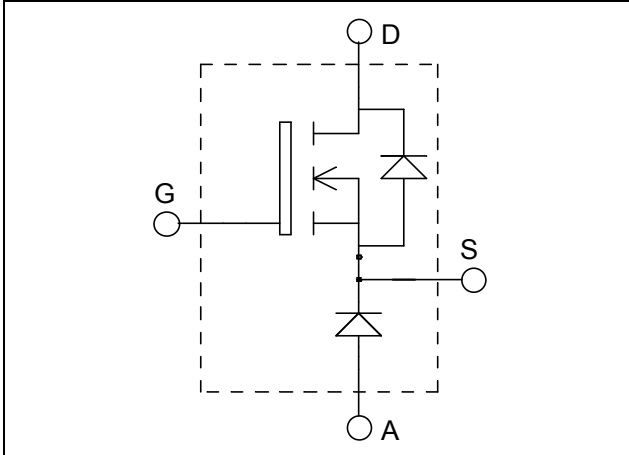

Application

- AC and DC motor control
- Switched Mode Power Supplies

Features

-  Power Semiconductors
 - Ultra low R_{DSon}
 - Low Miller capacitance
 - Ultra low gate charge
 - Avalanche energy rated
- ISOTOP[®] Package (SOT-227)
- Very low stray inductance
- High level of integration

Benefits

- Outstanding performance at high frequency operation
- Stable temperature behavior
- Very rugged
- Direct mounting to heatsink (isolated package)
- Low junction to case thermal resistance
- Easy paralleling due to positive T_c of V_{CEsat}
- RoHS Compliant

Absolute maximum ratings

Symbol	Parameter	Max ratings	Unit
V_{DSS}	Drain - Source Breakdown Voltage	900	V
I_D	Continuous Drain Current	$T_c = 25^\circ C$	33
		$T_c = 80^\circ C$	25
I_{DM}	Pulsed Drain current	75	A
V_{GS}	Gate - Source Voltage	± 20	V
R_{DSon}	Drain - Source ON Resistance	120	$m\Omega$
P_D	Maximum Power Dissipation	$T_c = 25^\circ C$	290
I_{AR}	Avalanche current (repetitive and non repetitive)	8.8	A
E_{AR}	Repetitive Avalanche Energy	2.9	mJ
E_{AS}	Single Pulse Avalanche Energy	1940	

CAUTION: These Devices are sensitive to Electrostatic Discharge. Proper Handling Procedures Should Be Followed. See application note APT0502 on www.microsemi.com

All ratings @ $T_j = 25^\circ\text{C}$ unless otherwise specified

Electrical Characteristics

Symbol	Characteristic	Test Conditions	Min	Typ	Max	Unit	
I_{DSS}	Zero Gate Voltage Drain Current	$V_{GS} = 0V, V_{DS} = 900V$	$T_j = 25^\circ\text{C}$			100	μA
		$V_{GS} = 0V, V_{DS} = 900V$	$T_j = 125^\circ\text{C}$		500		
$R_{DS(on)}$	Drain – Source on Resistance	$V_{GS} = 10V, I_D = 26A$		100	120	$\text{m}\Omega$	
$V_{GS(th)}$	Gate Threshold Voltage	$V_{GS} = V_{DS}, I_D = 3\text{mA}$	2.5	3	3.5	V	
I_{GSS}	Gate – Source Leakage Current	$V_{GS} = \pm 20V, V_{DS} = 0V$			100	nA	

Dynamic Characteristics

Symbol	Characteristic	Test Conditions	Min	Typ	Max	Unit
C_{iss}	Input Capacitance	$V_{GS} = 0V ; V_{DS} = 100V$ $f = 1\text{MHz}$		6.8		nF
C_{oss}	Output Capacitance			0.33		
Q_g	Total gate Charge	$V_{GS} = 10V$ $V_{Bus} = 400V$ $I_D = 26A$		270		nC
Q_{gs}	Gate – Source Charge			32		
Q_{gd}	Gate – Drain Charge			115		
$T_{d(on)}$	Turn-on Delay Time	Inductive Switching (125°C) $V_{GS} = 10V$ $V_{Bus} = 600V$ $I_D = 26A$ $R_G = 7.5\Omega$		70		ns
T_r	Rise Time			20		
$T_{d(off)}$	Turn-off Delay Time			400		
T_f	Fall Time			25		
E_{on}	Turn-on Switching Energy	Inductive switching @ 25°C $V_{GS} = 10V ; V_{Bus} = 600V$ $I_D = 26A ; R_G = 7.5\Omega$		1.5		mJ
E_{off}	Turn-off Switching Energy			0.75		
E_{on}	Turn-on Switching Energy	Inductive switching @ 125°C $V_{GS} = 10V ; V_{Bus} = 600V$ $I_D = 26A ; R_G = 7.5\Omega$		2.1		mJ
E_{off}	Turn-off Switching Energy			0.85		

Chopper diode ratings and characteristics

Symbol	Characteristic	Test Conditions	Min	Typ	Max	Unit	
V_{RRM}	Maximum Peak Repetitive Reverse Voltage		1200			V	
I_{RM}	Maximum Reverse Leakage Current	$V_R = 1200V$	$T_j = 25^\circ\text{C}$			100	μA
			$T_j = 125^\circ\text{C}$			500	
I_F	DC Forward Current			30		A	
V_F	Diode Forward Voltage	$I_F = 30A$		2.6	3.1	V	
		$I_F = 60A$		3.2			
		$I_F = 30A$	$T_j = 125^\circ\text{C}$	1.8			
t_{rr}	Reverse Recovery Time	$I_F = 30A$ $V_R = 800V$ $di/dt = 200A/\mu\text{s}$	$T_j = 25^\circ\text{C}$	300		ns	
			$T_j = 125^\circ\text{C}$	380			
Q_{rr}	Reverse Recovery Charge	$I_F = 30A$ $V_R = 800V$ $di/dt = 200A/\mu\text{s}$	$T_j = 25^\circ\text{C}$	360		nC	
			$T_j = 125^\circ\text{C}$	1700			

Thermal and package characteristics

Symbol Characteristic

		Min	Typ	Max	Unit
R_{thJC}	Junction to Case Thermal Resistance	CoolMOS		0.43	°C/W
		Diode		1.05	
R_{thJA}	Junction to Ambient (IGBT & Diode)			20	
V_{ISOL}	RMS Isolation Voltage, any terminal to case $t=1$ min, $I_{isol}<1$ mA, 50/60Hz	2500			V
T_J, T_{STG}	Storage Temperature Range	-40		150	°C
T_L	Max Lead Temp for Soldering: 0.063" from case for 10 sec			300	
Torque	Mounting torque (Mounting = 8-32 or 4mm Machine and terminals = 4mm Machine)			1.5	N.m
Wt	Package Weight		29.2		g

SOT-227 (ISOTOP®) Package Outline

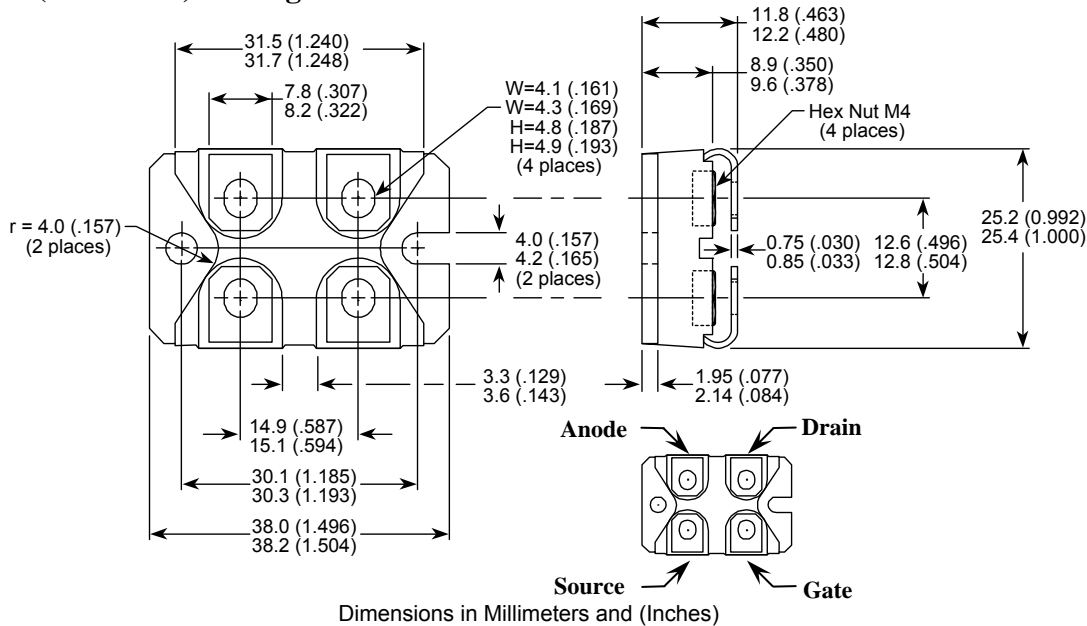

Typical CoolMOS performance Curve

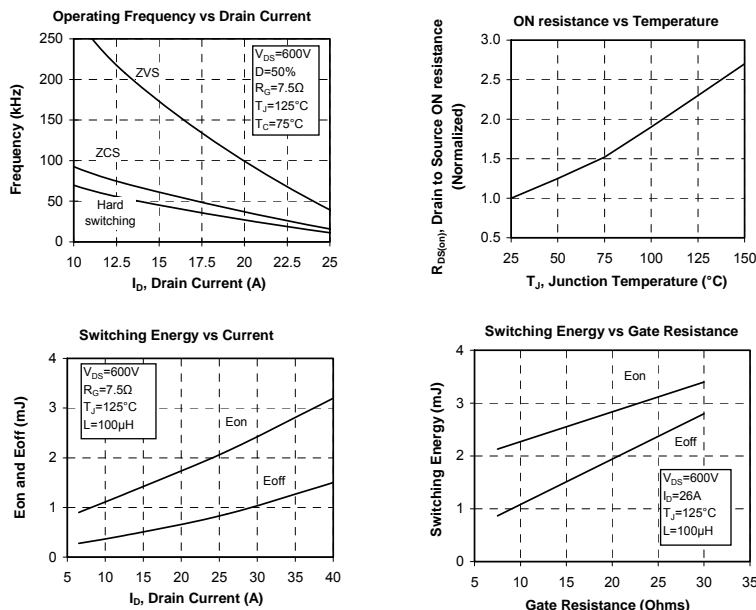

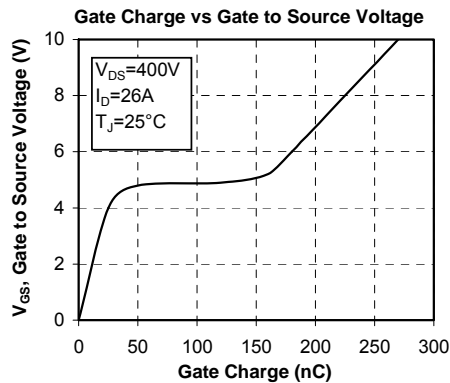
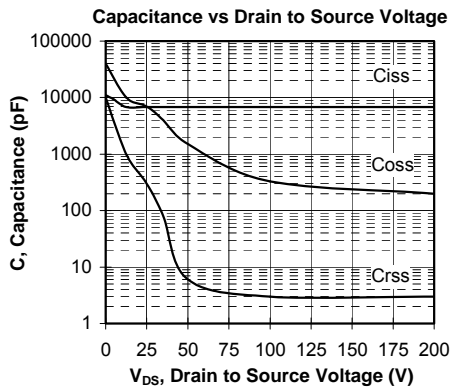
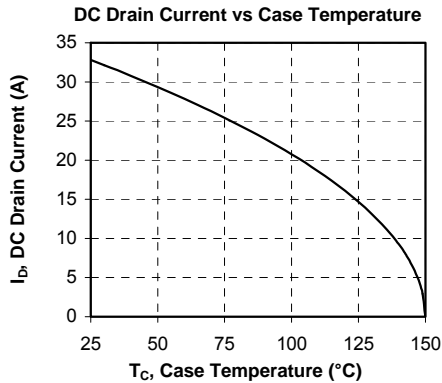
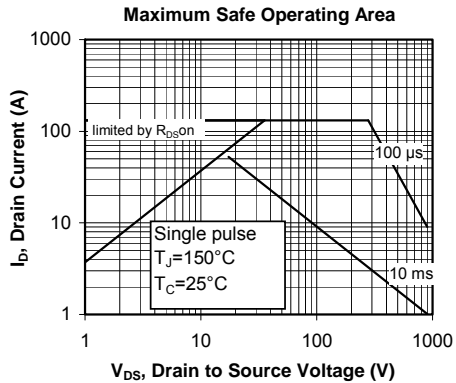
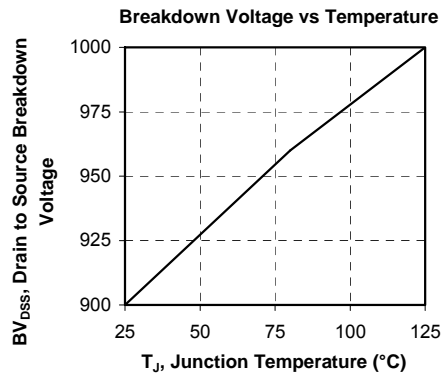
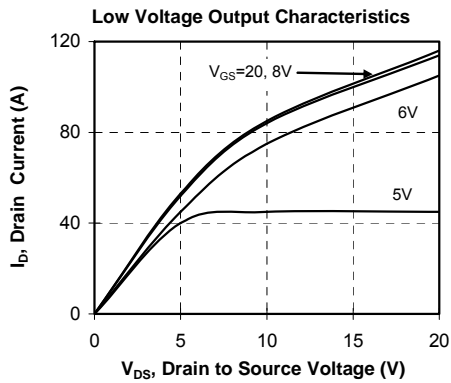
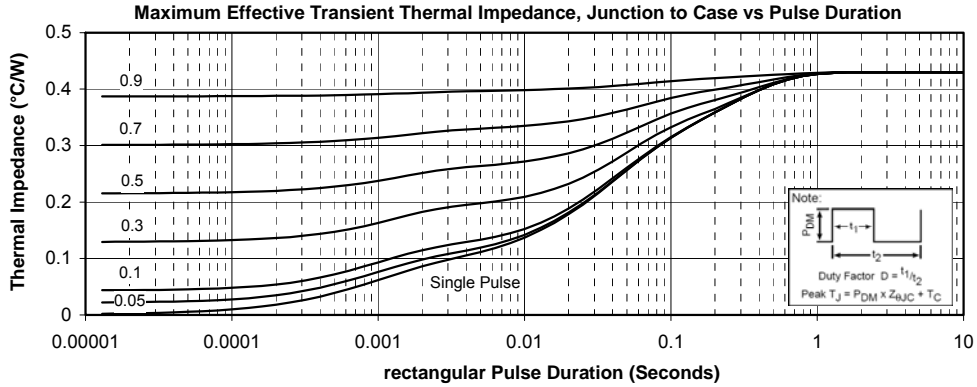

Typical Chopper diode performance Curve

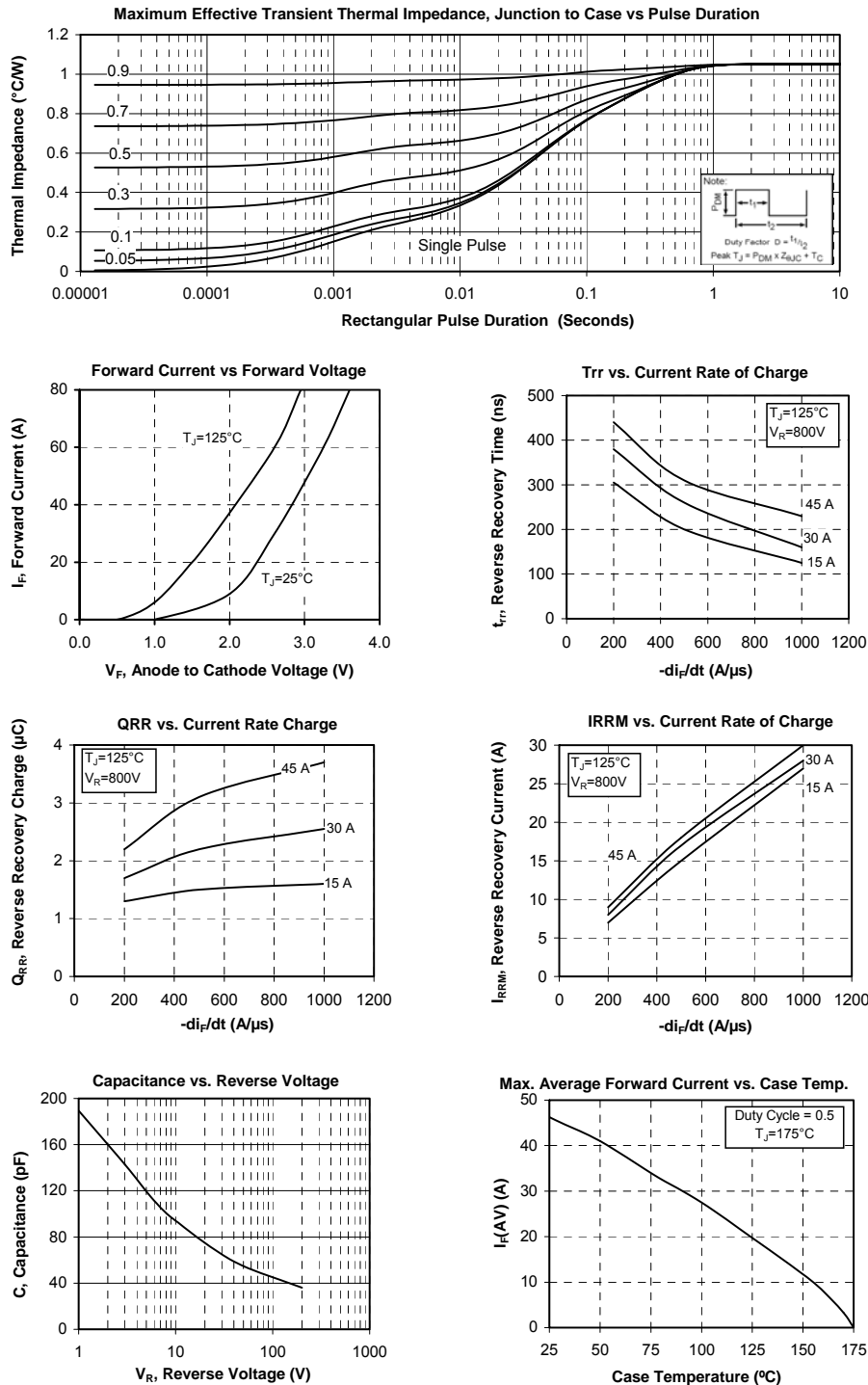

“COOLMOS™ comprise a new family of transistors developed by Infineon Technologies AG. “COOLMOS” is a trademark of Infineon Technologies AG”.

Microsemi reserves the right to change, without notice, the specifications and information contained herein

Microsemi's products are covered by one or more of U.S patents 4,895,810 5,045,903 5,089,434 5,182,234 5,019,522 5,262,336 6,503,786 5,256,583 4,748,103 5,283,202 5,231,474 5,434,095 5,528,058 6,939,743 7,352,045 5,283,201 5,801,417 5,648,283 7,196,634 6,664,594 7,157,886 6,939,743 7,342,262 and foreign patents. U.S and Foreign patents pending. All Rights Reserved.