

## HEXFET® TRANSISTORS

## IRF9140

**P-CHANNEL  
100 VOLT  
POWER MOSFETs**

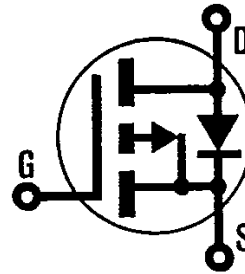

## IRF9141

## IRF9142

## IRF9143

### -100 Volt, 0.2 Ohm HEXFET

The HEXFET® technology is the key to International Rectifier's advanced line of power MOSFET transistors. The efficient geometry and unique processing of the HEXFET design achieve very low on-state resistance combined with high transconductance and extreme device ruggedness.

The P-Channel HEXFETs are designed for applications which require the convenience of reverse polarity operation. They retain all of the features of the more common N-Channel HEXFETs such as voltage control, very fast switching, ease of paralleling, and excellent temperature stability. The P-Channel IRF9140 device is an approximate electrical complement to the N-Channel IRF130 HEXFET.

P-Channel HEXFETs are intended for use in power stages where complementary symmetry with N-Channel devices offers circuit simplification. They are also very useful in drive stages because of the circuit versatility offered by the reverse polarity connection. Applications include motor control, audio amplifiers, switched mode converters, control circuits and pulse amplifiers.

### Features:

- P-Channel Versatility
- Fast Switching
- Low Drive Current
- Ease of Paralleling
- Excellent Temperature Stability

### Product Summary

Part Number	$V_{DS}$	$R_{DS(on)}$	$I_D$
IRF9140	-100V	$0.2\Omega$	-19A
IRF9141	-60V	$0.2\Omega$	-19A
IRF9142	-100V	$0.3\Omega$	-15A
IRF9143	-60V	$0.3\Omega$	-15A

### CASE STYLE AND DIMENSIONS

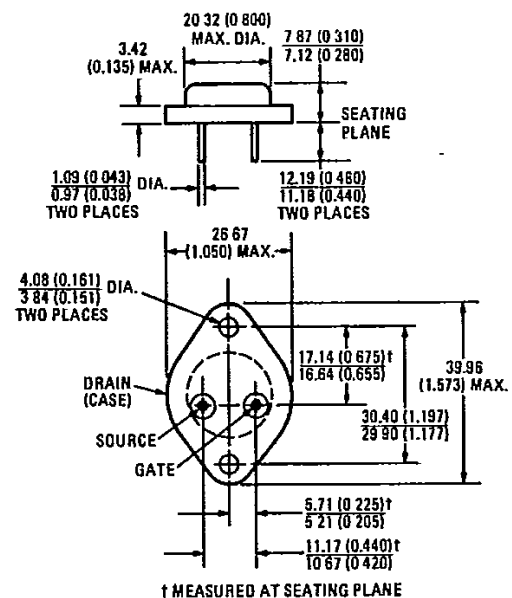
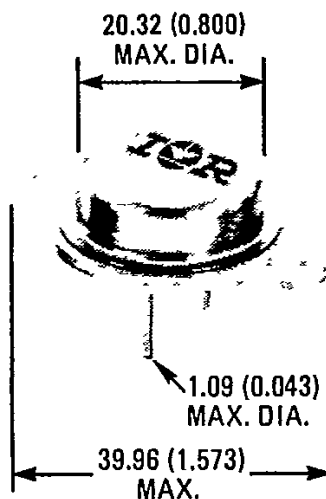

Conforms to JEDEC Outline TO-204AA (TO-3)  
Dimensions in Millimeters and (Inches)

Absolute Maximum Ratings

Parameter	IRF9140	IRF9141	IRF9142	IRF9143	Units
V <sub>DS</sub> Drain - Source Voltage ①	-100	-60	-100	-60	V
V <sub>DGR</sub> Drain - Gate Voltage (R <sub>GS</sub> = 20 kΩ) ①	-100	-60	-100	-60	V
I <sub>D</sub> @ T <sub>C</sub> = 25°C Continuous Drain Current	-19	-19	-15	-15	A
I <sub>D</sub> @ T <sub>C</sub> = 100°C Continuous Drain Current	-12	-12	-10	-10	A
I <sub>DM</sub> Pulsed Drain Current ③	-76	-76	-60	-60	A
V <sub>GS</sub> Gate - Source Voltage	± 20				V
P <sub>D</sub> @ T <sub>C</sub> = 25°C Max. Power Dissipation	125 (See Fig. 14)				W
Linear Derating Factor	1.0 (See Fig. 14)				W/K ④
I <sub>LM</sub> Inductive Current, Clamped	(See Fig. 15 and 16) L = 100μH				A
	-76	-76	-60	-60	
T <sub>J</sub> Operating Junction and Storage Temperature Range	-55 to 150				°C
T <sub>stg</sub> Lead Temperature	300 (0.063 in. (1.6mm) from case for 10s)				°C

Electrical Characteristics @ T<sub>C</sub> = 25°C (Unless Otherwise Specified)

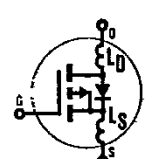
Parameter	Type	Min.	Typ.	Max.	Units	Test Conditions	
BV <sub>DSS</sub> Drain - Source Breakdown Voltage	IRF9140 IRF9142	-100	-	-	V	V <sub>GS</sub> = 0V	
	IRF9141 IRF9143	-60	-	-	V	I <sub>D</sub> = -250μA	
V <sub>GS(th)</sub> Gate Threshold Voltage	ALL	-2.0	-	-4.0	V	V <sub>DS</sub> = V <sub>GS</sub> , I <sub>D</sub> = -250μA	
I <sub>GSS</sub> Gate - Source Leakage Forward	ALL	-	-	-100	nA	V <sub>GS</sub> = -20V	
I <sub>GSS</sub> Gate - Source Leakage Reverse	ALL	-	-	100	nA	V <sub>GS</sub> = 20V	
I <sub>DSS</sub> Zero Gate Voltage Drain Current	ALL	-	-	-250	μA	V <sub>DS</sub> = Max. Rating, V <sub>GS</sub> = 0V	
		-	-	-1000	μA	V <sub>DS</sub> = Max. Rating x 0.8, V <sub>GS</sub> = 0V, T <sub>C</sub> = 125°C	
I <sub>D(on)</sub> On-State Drain Current ②	IRF9140 IRF9141	-19	-	-	A	V <sub>DS</sub> > I <sub>D(on)</sub> × R <sub>Ds(on)max.</sub> , V <sub>GS</sub> = -10V	
	IRF9142 IRF9143	-15	-	-	A		
R <sub>Ds(on)</sub> Static Drain-Source On-State Resistance ②	IRF9140 IRF9141	-	0.15	0.2	Ω	V <sub>GS</sub> = 10V, I <sub>D</sub> = -10A	
	IRF9142 IRF9143	-	0.22	0.3	Ω		
g <sub>fs</sub> Forward Transconductance ②	ALL	5.0	7.0	-	S (Ω)	V <sub>DS</sub> > I <sub>D(on)</sub> × R <sub>Ds(on)max.</sub> , I <sub>D</sub> = -10A	
C <sub>iss</sub> Input Capacitance	ALL	-	1100	1300	pF	V <sub>GS</sub> = 0V, V <sub>DS</sub> = -25V, f = 1.0 MHz See Fig. 10	
C <sub>oss</sub> Output Capacitance	ALL	-	550	700	pF		
C <sub>rss</sub> Reverse Transfer Capacitance	ALL	-	250	400	pF		
t <sub>d(on)</sub> Turn-On Delay Time	ALL	-	20	30	ns	V <sub>DD</sub> = 0.5 BV <sub>DSS</sub> , I <sub>D</sub> = -10A, Z <sub>0</sub> = 4.7Ω See Fig. 17 (MOSFET switching times are essentially independent of operating temperature.)	
t <sub>r</sub> Rise Time	ALL	-	10	15	ns		
t <sub>d(off)</sub> Turn-Off Delay Time	ALL	-	13	20	ns		
t <sub>f</sub> Fall Time	ALL	-	8.0	12	ns		
Q <sub>g</sub> Total Gate Charge (Gate-Source Plus Gate-Drain)	ALL	-	70	90	nC	V <sub>GS</sub> = -15V, I <sub>D</sub> = -24A, V <sub>DS</sub> = 0.8 Max. Rating. See Fig. 18 for test circuit. (Gate charge is essentially independent of operating temperature.)	
Q <sub>gs</sub> Gate-Source Charge	ALL	-	14	-	nC		
Q <sub>gd</sub> Gate-Drain ("Miller") Charge	ALL	-	56	-	nC		
L <sub>D</sub> Internal Drain Inductance	ALL	-	5.0	-	nH	Measured between the contact screw on header that is closer to source and gate pins and center of die.	Modified MOSFET symbol showing the internal device inductances. 
L <sub>S</sub> Internal Source Inductance	ALL	-	12.5	-	nH	Measured from the source pin, 6 mm (0.25 in.) from header and source bonding pad.	

Thermal Resistance

R <sub>thJC</sub> Junction-to-Case	ALL	-	-	1.0	K/W ④	
R <sub>thCS</sub> Case-to-Sink	ALL	-	0.1	-	K/W ④	Mounting surface flat, smooth, and greased.
R <sub>thJA</sub> Junction-to-Ambient	ALL	-	-	30	K/W ④	Typical socket mount

# Source-Drain Diode Ratings and Characteristics

T-39-23



$I_S$	Continuous Source Current (Body Diode)	IRF9140	-	-	-19	A	Modified MOSFET symbol showing the integral reverse P-N junction rectifier.
		IRF9141	-	-	-15	A	
$I_{SM}$	Pulse Source Current (Body Diode) ③	IRF9140	-	-	-76	A	
		IRF9141	-	-	-60	A	
$V_{SD}$	Diode Forward Voltage ②	IRF9140	-	-	-4.2	V	$T_C = 25^\circ\text{C}, I_S = -19\text{A}, V_{GS} = 0\text{V}$
		IRF9141	-	-	-4.0	V	
$t_{rr}$	Reverse Recovery Time	ALL	-	170	-	ns	$T_J = 150^\circ\text{C}, I_F = -19\text{A}, dI_F/dt = 100\text{A}/\mu\text{s}$
$Q_{RR}$	Reverse Recovered Charge	ALL	-	0.8	-	$\mu\text{C}$	$T_J = 150^\circ\text{C}, I_F = -19\text{A}, dI_F/dt = 100\text{A}/\mu\text{s}$
$t_{on}$	Forward Turn-on Time	ALL	Intrinsic turn-on time is negligible. Turn-on speed is substantially controlled by $L_S + L_D$ .				

- ①  $T_J = 25^\circ\text{C}$  to  $150^\circ\text{C}$ .
- ② Pulse Test: Pulse width  $\leq 300\mu\text{s}$ , Duty Cycle  $\leq 2\%$ .
- ③ Repetitive Rating: Pulse width limited by max. junction temperature. See Transient Thermal Impedance Curve (Fig. 5).
- ④  $K/W = ^\circ\text{C}/W$   
 $W/K = W/^\circ\text{C}$

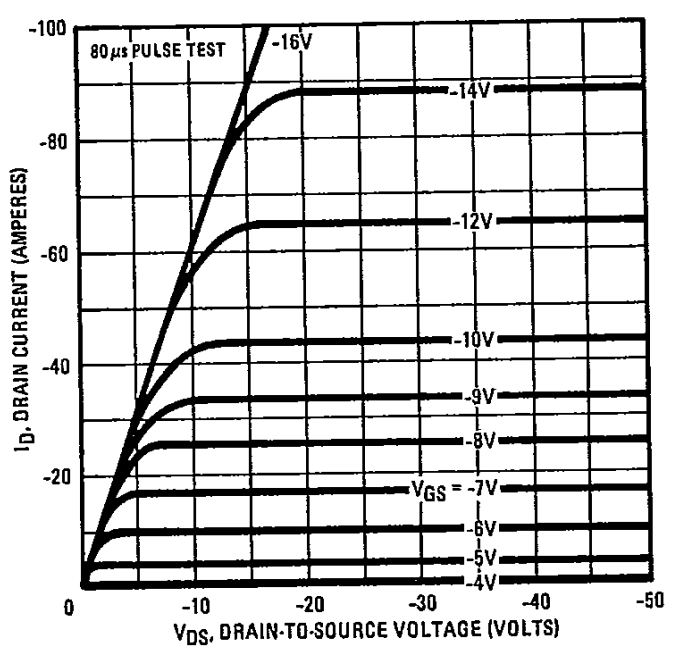

Fig. 1 - Typical Output Characteristics

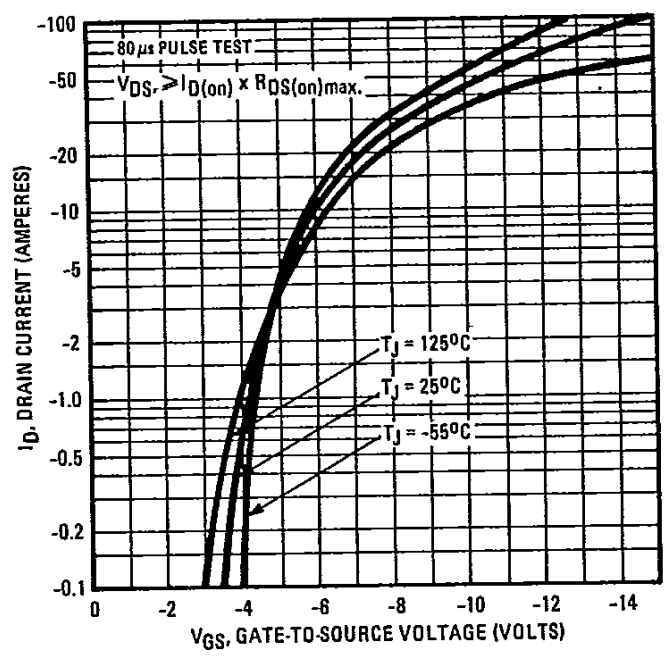

Fig. 2 - Typical Transfer Characteristics

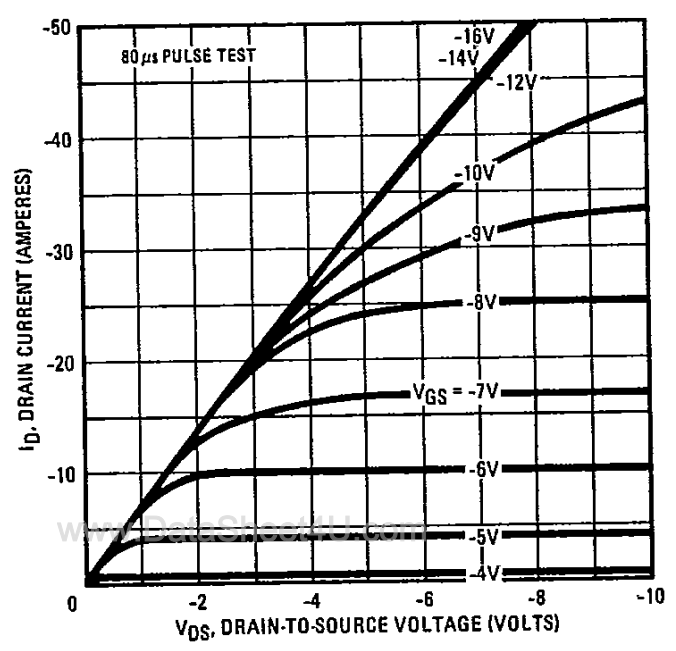

Fig. 3 - Typical Saturation Characteristics

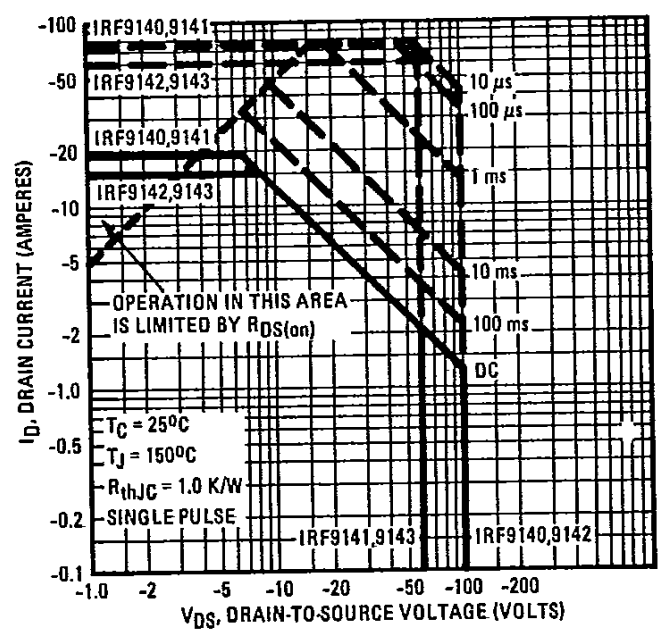

Fig. 4 - Maximum Safe Operating Area

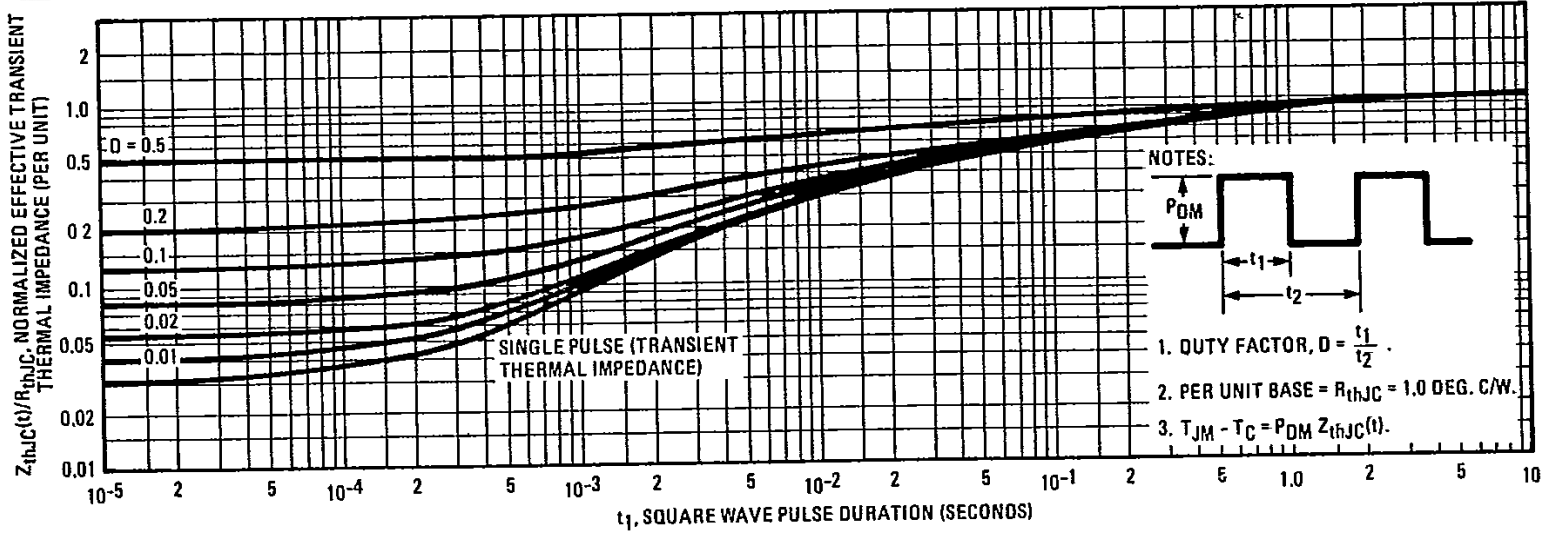

Fig. 5 – Maximum Effective Transient Thermal Impedance, Junction-to-Case Vs. Pulse Duration

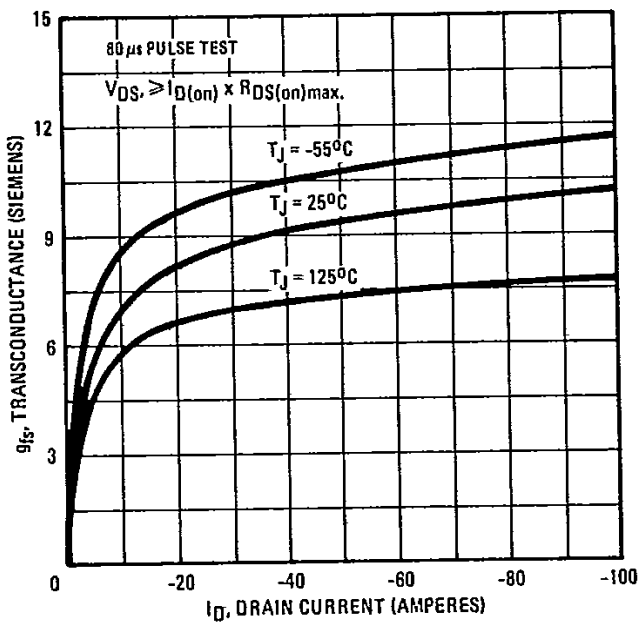

Fig. 6 – Typical Transconductance Vs. Drain Current

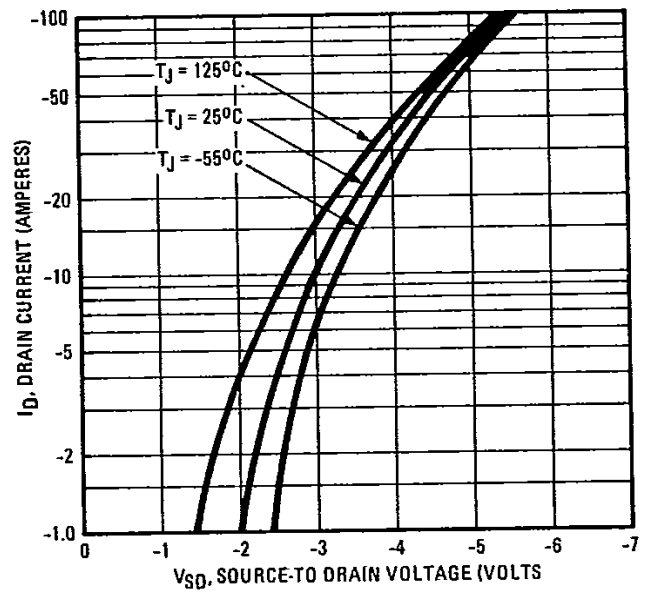

Fig. 7 – Typical Source-Drain Diode Forward Voltage

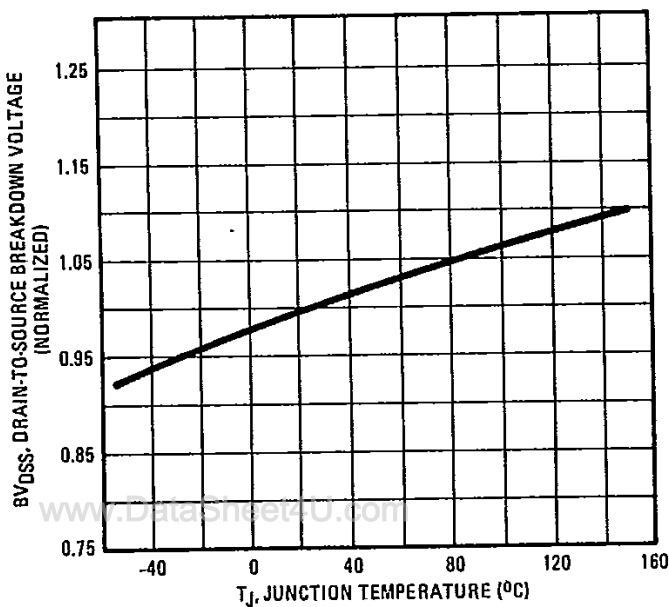

Fig. 8 – Breakdown Voltage Vs. Temperature

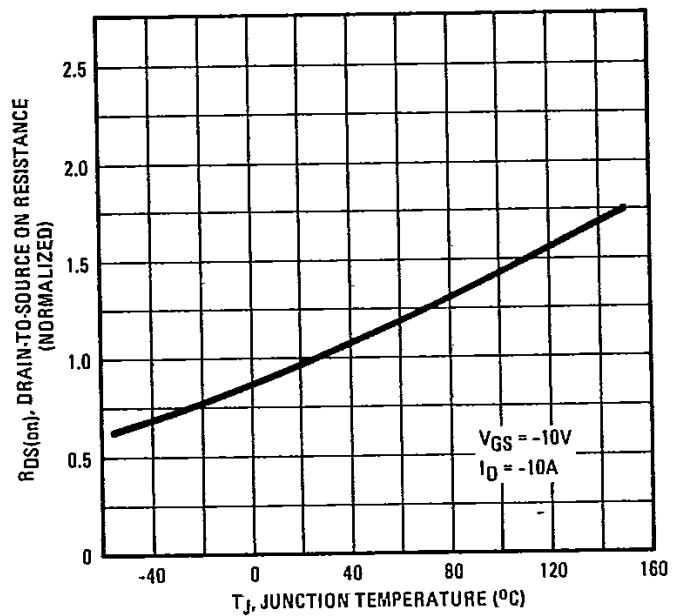

Fig. 9 – Normalized On-Resistance Vs. Temperature

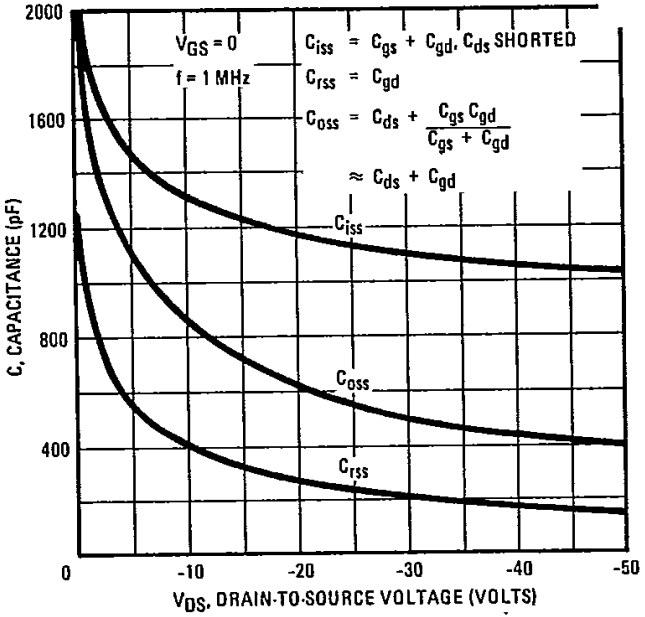

Fig. 10 - Typical Capacitance Vs. Drain-to-Source Voltage

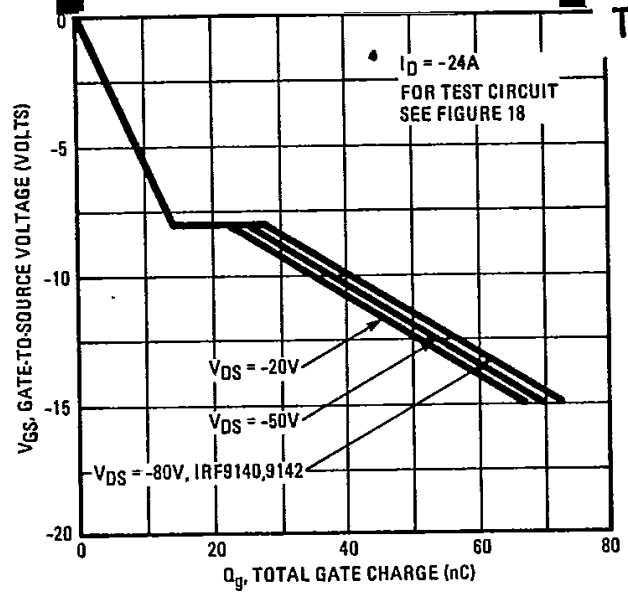

Fig. 11 - Typical Gate Charge Vs. Gate-to-Source Voltage

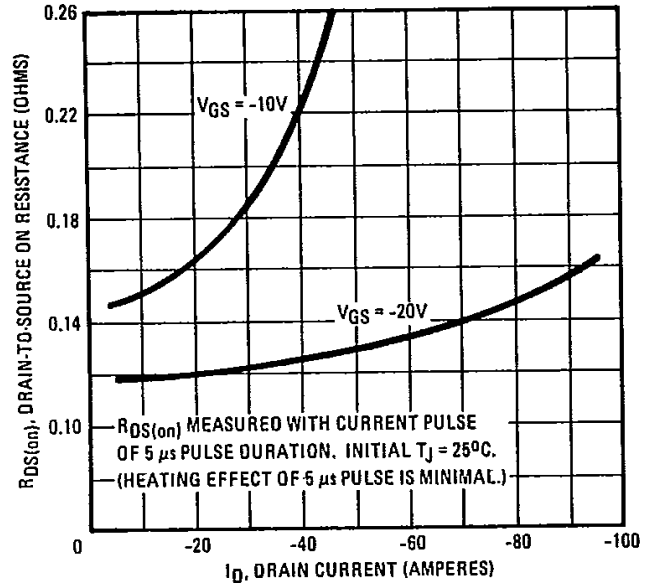

Fig. 12 - Typical On-Resistance Vs. Drain Current

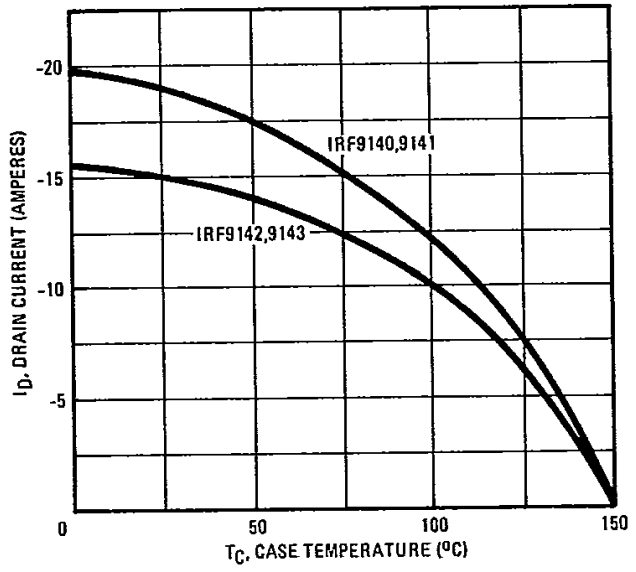

Fig. 13 - Maximum Drain Current Vs. Case Temperature

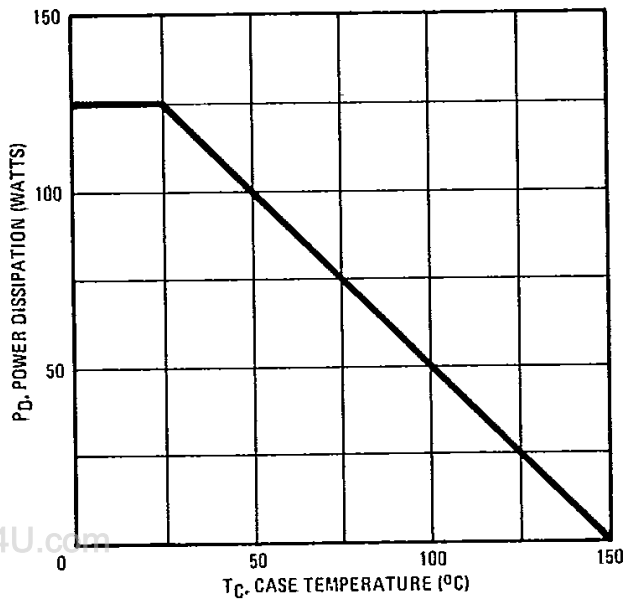

Fig. 14 - Power Vs. Temperature Derating Curve

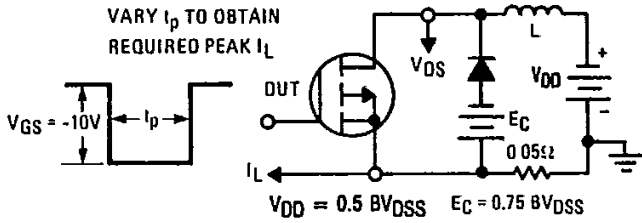

Fig. 15 – Clamped Inductive Test Circuit

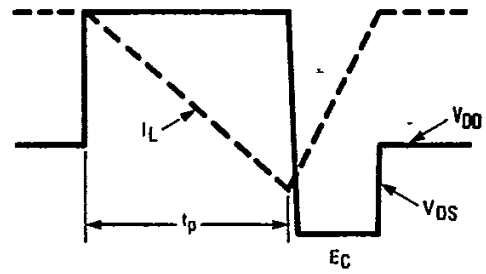

Fig. 16 – Clamped Inductive Waveforms

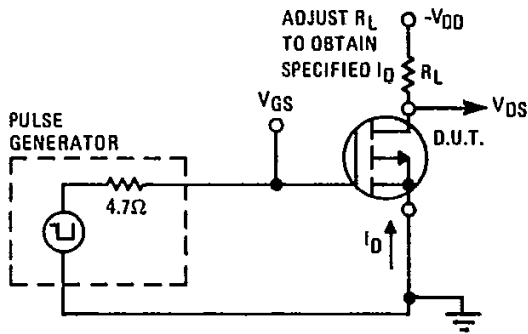

Fig. 17 – Switching Time Test Circuit

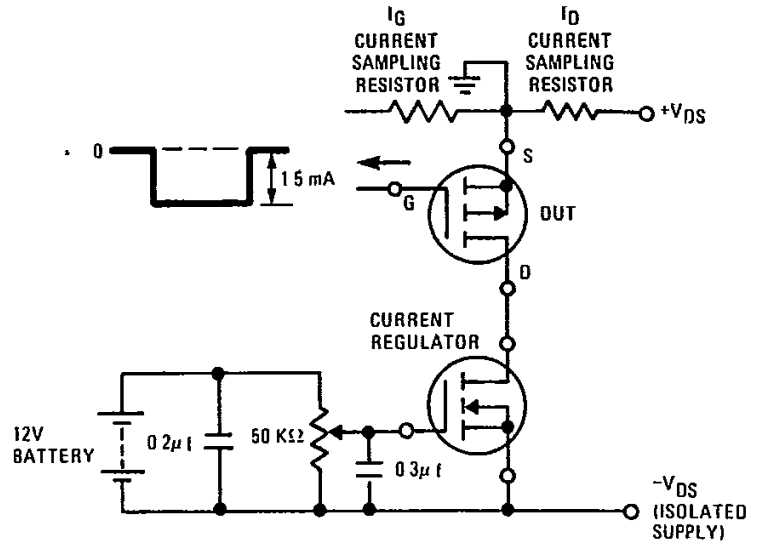

Fig. 18 – Gate Charge Test Circuit

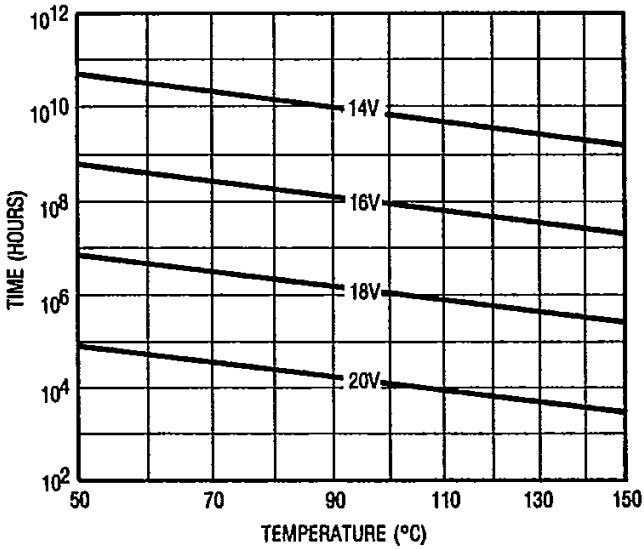

Fig. 19 – Typical Time to Accumulated 1% Failure

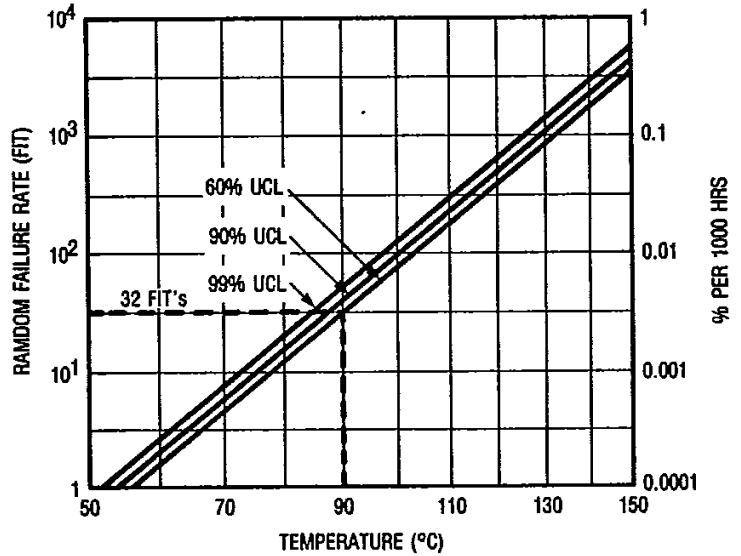

Fig. 20 – Typical High Temperature Reverse Bias (HTRB) Failure Rate

\*The data shown is correct as of April 15, 1987. This information is updated on a quarterly basis; for the latest reliability data, please contact your local IR field office.