

High Precision, Digital Pressure Switch Series ZSE40/ISE40

How to Order

Set pressure range

Nil	-0.100 to 1.000 MPa	For positive pressure
-----	---------------------	-----------------------

For positive pressure

ISE40

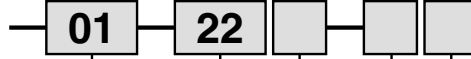

For vacuum/compound pressure

ZSE40

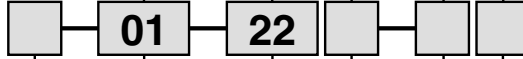

Set pressure range

Nil	10.0 to -101.3 kPa	For vacuum pressure
F	-100.0 to 100.0 kPa	For compound pressure

Piping specifications

<p>01: R 1/8 (With M5 female threads) T1: NPT 1/8 (With M5 female threads)</p>	<p>W1: Rc 1/8</p> <p>Reverse pressure two directions</p>
<p>* C4: With ø4 One-touch fitting * C6: With ø6 One-touch fitting</p> <p>Wall mount</p>	<p>* M5: M5 x 0.8 (Female threads)</p> <p>Wall mount</p>

* Option

Input/Output specifications

22	NPN open collector 2 outputs + analog output
30 *	NPN open collector 2 outputs + auto shift input
62 *	PNP open collector 2 outputs + analog output
70 *	PNP open collector 2 outputs + auto shift input

* Option

Note

When equipped with auto shift function, the following ranges can be set.

Set pressure range	Setting range
-100.0 to 100.0 kPa	-100.0 to 100.0 kPa
10.0 to -101.3 kPa	-101.3 to 101.3 kPa
-0.1 to 1.000 MPa	-1.000 to 1.000 MPa

Option

Nil	None
A	Bracket A (ZS-24-A)
B	Bracket B (ZS-24-B)
E	Panel mount (ZS-22-A)
F	Panel mount (ZS-24-C) + Front protective cover

* When optional parts only are required, order with the part numbers inside ().

Unit specifications

Nil	With unit switching function ^{Note1)}
M	SI unit only ^{Note 2)}

Note 1) This will no longer be sold for use in Japan after the new Weight and Measure Act is implemented (October, 1999).

Note 2) Fixed unit
For vacuum/compound pressure: kPa
For positive pressure: MPa

Lead wire length

Nil	0.6 m
L	3 m

ZSE□
ISE□

PSE

ZSE3

PS

ZSE₁
ZSE₂

ZSP

ISA2

IS□

ZSM

PF2□

IF□

Data

Series ZSE40/ISE40

Specifications

	ZSE40F (Compound pressure)	ZSE40 (Vacuum pressure)	ISE40 (Positive pressure)
Rated pressure range	-100.0 to 100.0 kPa	0.0 to -101.3 kPa	0.000 to 1.000 MPa
Operating pressure range/Set pressure range	-100.0 to 100.0 kPa	10.0 to -101.3 kPa	-0.100 to 1.000 MPa
Withstand pressure	500 kPa		1.5 MPa
Set pressure resolution <small>Note 1)</small>	kPa	0.1	—
	MPa	—	0.001
	kgf/cm ²	0.001	0.01
	bar	0.001	0.01
	psi	0.02	0.01
	mmHG	1	—
		0.1	—
Applicable fluid	Air, Non-corrosive/Non-flammable gas		
Power supply voltage	12 to 24 VDC ±10%, Ripple (p-p) 10% or less		
Current consumption	55 mA or less		
Switch output	NPN or PNP 2 outputs	Max. load current : 80 mA Max. applied voltage: 30 VDC (With NPN output) Residual voltage : 1 V or less (With 80 mA load current)	
Repeatability	±0.2% F.S. ±1digit or less		
Hysteresis	Hysteresis mode	Variable	
	Window comparator mode	Fixed (3 digits) <small>Note4)</small>	
Response time (With anti-chattering function)	2.5 ms or less (With anti-chattering function: 24 ms, 192 ms and 768 ms selections)		
Output short circuit protection	Yes		
Display	3 1/2 digit LED display (Sampling cycle: 5 times/sec.)		
Display accuracy	±2% F.S. ±1 digit or less (at ambient temperature of 25 ±3°C)		
Indicator light	Green LED (OUT1: Lights when ON), Red LED (OUT2: Lights when ON)		
Analog output <small>Note 2)</small>	Output voltage: 1 to 5 V ±5% F.S. or less (in rated pressure range) Linearity: ±1% F.S. or less Output impedance: Approx. 1 kΩ	Output voltage: 1 to 5 V ±2.5% F.S. or less (in rated pressure range) Linearity: ±1% F.S. or less Output impedance: Approx. 1 kΩ	
Auto shift input <small>Note 3)</small>	No-voltage input (Reed or solid state), input 5 ms or more		
Environmental resistance	Enclosure	IP65	
	Ambient temperature range	Operating: 0 to 50°C, Stored: -10 to 60°C (No condensation or freezing)	
	Ambient humidity range	Operating/Stored: 35 to 85% RH (No condensation)	
	Withstand voltage	1000 VAC for 1 min. between lead wires and body	
	Insulation resistance	50 MΩ or more (at 500 VDC) between lead wires and body	
	Vibration resistance	10 to 500 Hz at the smaller of amplitude 1.5 mm or acceleration 98 m/s ² (10 G) in X, Y, Z directions for 2 hrs. each (De-energized)	
Impact resistance	980 m/s ² (100 G) in X, Y, Z directions 3 times each (De-energized)		
Temperature characteristics	In a temperature range of 0 to 50°C, ±2% F.S. or less of pressure measured at 25°C		
Port size	01: R 1/8, M5 x 0.8, T1: NPT1/8, M5 x 0.8, W1: Rc 1/8 C4: With ø4 One-touch fitting, C6: With ø6 One-touch fitting, M5: M5 female threads		
Lead wire	5-wire oil resistant heavy-duty cord (0.15 mm ²)		
Weight	01/T1 types approx. 60 g, W1 type approx. 80 g, C4/C6/M5 types approx. 92 g (Each including 0.6 m lead wires)		

Note 1) Equipped with unit switching function
(Types without the unit switching function use SI units (kPa or MPa) only.)

Note 2) For ZSE40 (F)/ISE40-□-22

Note 3) For ZSE40 (F)/ISE40-□-30

Note 4) For ZSE40F (compound pressure) with "psi" indication, this is 0.03 to 0.04 psi.

Note 5) For ZSE40F (compound pressure) with "psi" indication, zero clear is in the range of ±0.01 psi.

Note)

When equipped with auto shift function, the following ranges can be set.

Set pressure range	Setting range
-100.0 to 100.0 kPa	-100.0 to 100.0 kPa
10.0 to -101.3 kPa	-101.3 to 101.3 kPa
-0.1 to 1.000 MPa	-1.000 to 1.000 MPa

Example of Internal Circuit and Wiring

**ZSE40(F)
ISE40-□-22(L)-(M)**
With analog output

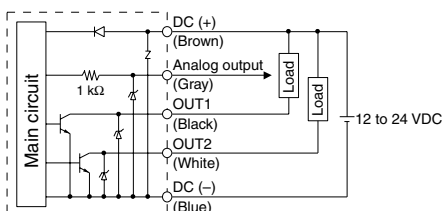

**ZSE40(F)
ISE40-□-62(L)-(M)**
With analog output

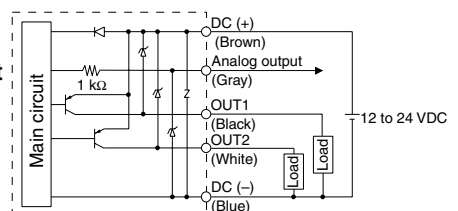

**ZSE40(F)
ISE40-□-30(L)-(M)**
With auto shift input

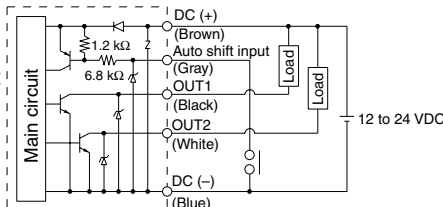

**ZSE40(F)
ISE40-□-70(L)-(M)**
With auto shift input

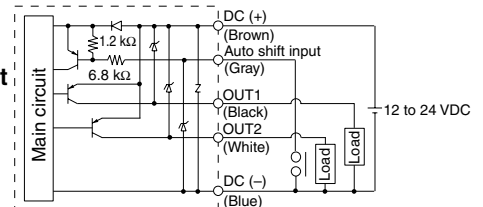

Description

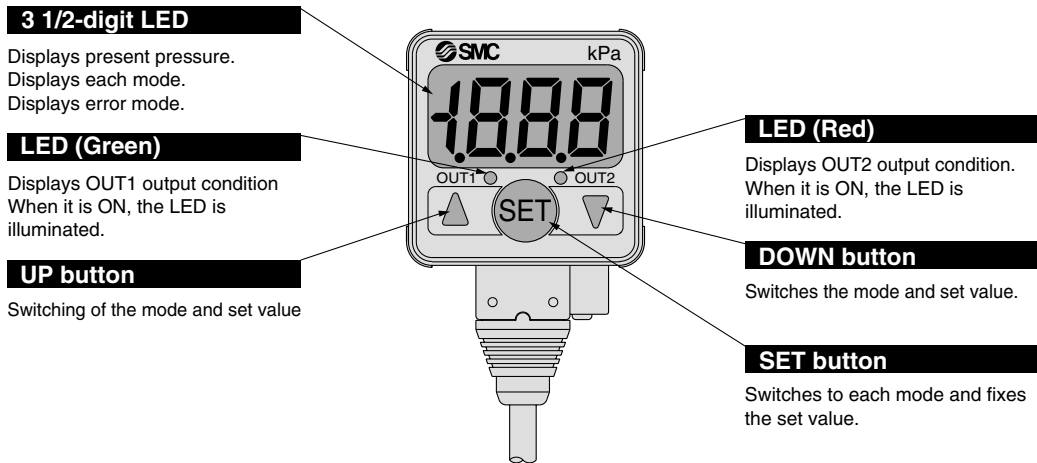

Calibration Procedures

Setting procedure

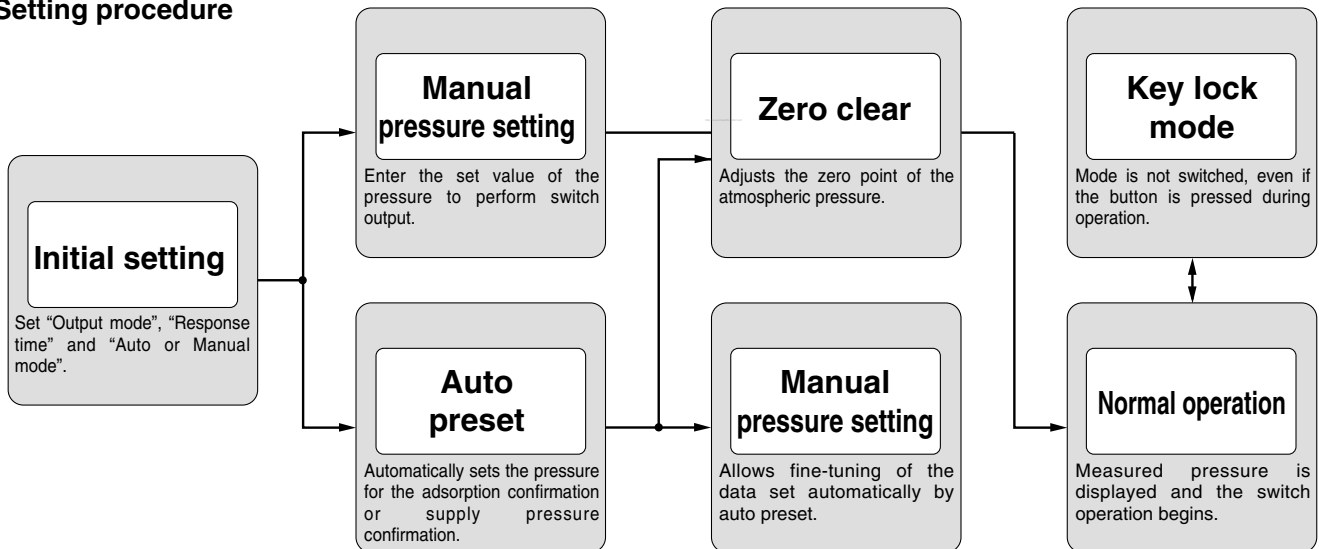

- ZSE
- ISE
- PSE
- ZSE3
- PS
- ZSE1
- ZSE2
- ZSP
- ISA2
- IS
- ZSM
- PF2
- IF
- Data

Series ZSE40/ISE40

Calibration Procedures

Initial Setting

1. Initial condition mode



Press the "SET" button for more than 2 seconds until "1no" is displayed. Release it when the display turns to "1nc".

Unit mode: When using a product with a unit switching function, refer to the next page for unit-setting (for overseas).

2. Selection of output mode OUT1

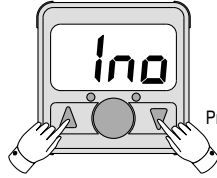

Select the "output mode" for OUT1 by pressing either ▲ button or ▼ button.
"1no" Normally open mode
"1nc" Normally closed mode

3. Selection of output mode OUT2

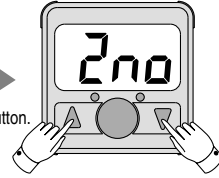

Select the "output mode" for OUT2 by pressing either ▲ button or ▼ button.
"2no" Normally open mode
"2nc" Normally closed mode

4. Selection of response time

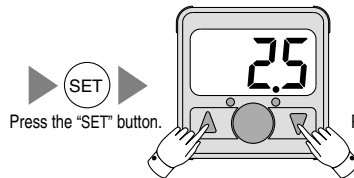

Select the response time by pressing either ▲ button or ▼ button.
("2.5": 2.5 ms, "24": 24 ms,
"192": 192 ms, "768": 768 ms
Select among them.)

5. Setting Auto/Manual

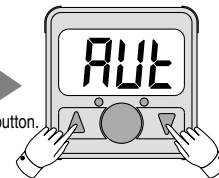

Select "Auto preset mode" or "Manual set mode" by pressing either ▲ button or ▼ button.
"AUT" Auto preset mode
"MAN" Manual set mode

Manual Pressure Setting

Output mode differs by the pressure set value.

1. Manual set mode



Select the manual set mode in the initial condition mode and press the "SET" button until "P_1" or "n_1" is displayed.

2. Input set point value for OUT1 (1)



▲ button: Increases set value
▼ button: Decreases set value
Displays the set values "P_1" or "n_1" alternately.

3. Input set point value for OUT1 (2)

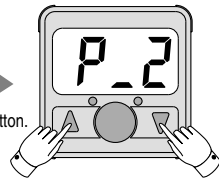

▲ button: Increases set value
▼ button: Decreases set value
Displays the set values "P_2" or "n_2" alternately.

4. Input set point value for OUT2 (1)

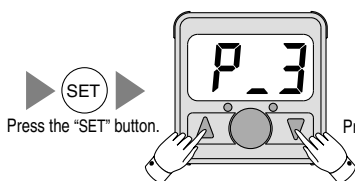

▲ button: Increases set value
▼ button: Decreases set value
Displays the set values "P_3" or "n_3" alternately.

5. Input set point value for OUT2 (2)

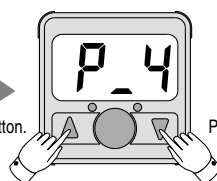

▲ button: Increases set value
▼ button: Decreases set value
Displays the set values "P_4" or "n_4" alternately.

6. Display of setting auto shift

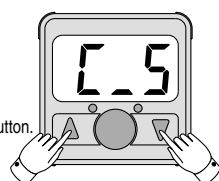

※ Only for ZSE40(F)/ISE40-□-30/70(L)-M, displays the input mode "C_5" and the compensation value alternately. If auto shift input is not complete, zero is displayed.

Unit Set

It's only subject to ZSE40(F)/ISE40-□-□(L).

Unit selection



Set the unit by either ▲ button or ▼ button.
 PPa: kPa or MPa, ρF: kgf/cm²,
 bPa: bar, P5: psi,
 inHg: inHg, mmHg: mmHg



OUT1: Selection of the output mode

Output Type

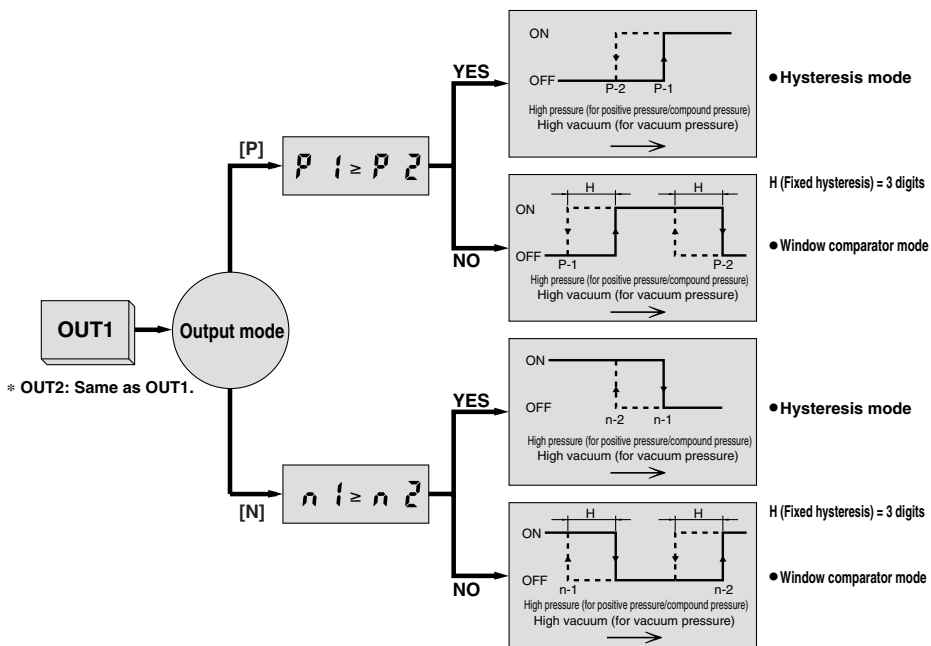

- ZSE□
- ISE□
- PSE
- ZSE3
- PS
- ZSE1
- ZSE2
- ZSP
- ISA2
- IS□
- ZSM
- PF2□
- IF□
- Data

Auto Preset (For adsorption confirmation)

1. Auto preset mode



Select the Auto preset mode in the initial setting mode and press the "SET" button until "RP1" is displayed.

2. Preparation for auto preset



Prepare the equipment for use under operating conditions. When setting **OUT1** is not required, press both the ▲ button and ▼ button simultaneously in this state to skip to "RP2".

3. Auto preset of OUT1

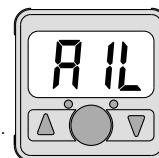

Repeat adsorption and non-adsorption release several times in this state. The optimal set value is determined automatically.

4. Preparation for auto preset



Press the "SET" button.

5. Auto preset of OUT2

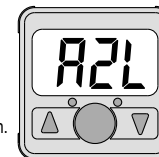

Press the "SET" button.

Press the "SET" button to complete the setting.

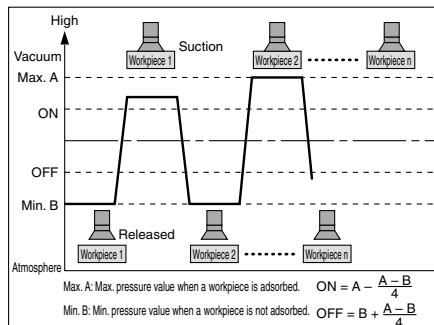

Supplies vacuum pressure, changing the condition of a workpiece by adsorption nozzle, etc. When setting **OUT2** is not required, press both the ▲ button and ▼ button simultaneously in this state to skip to the measurement mode.

Repeat adsorption and non-adsorption several times in this state. The optimum set value is determined automatically.

Series ZSE40/ISE40

Calibration Procedures

Auto Preset (In the case of confirming the supply pressure)

1. Auto preset mode



Select the Auto preset mode in the initial setting mode and press the "SET" button until "RP 1" is displayed.

2. Preparation for auto preset



Prepare the equipment for use under operating conditions. When setting OUT1 is not required, press both the ▲ button and ▼ button simultaneously in this state to skip to "RP2".

3. Auto preset of OUT1

Press the "SET" button.

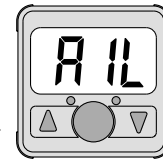

The pressure is read and the optimal set value is determined automatically.

4. Preparation for auto preset

Press the "SET" button.



Prepare the equipment for use under operating conditions of OUT2. When setting OUT2 is not required, press both the ▲ button and ▼ button simultaneously in this state to skip to the measurement mode.

5. Auto preset of OUT2

Press the "SET" button.

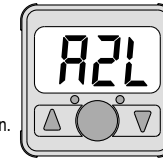

Press the "SET" button to complete the setting.

The pressure is read and the optimal set value is determined automatically.

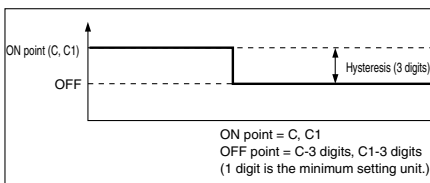

Other Functions

- **Key lock mode** ----- Used to avoid a malfunction when buttons on the front part of the switch are pressed.

Initiate key lock



Press the "SET" button for 4 seconds or longer. Release it when the display turns to "UnL".



Display "LoL" by pressing ▲ button or ▼ button.

Release key lock

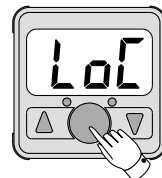

Press the "SET" button for 4 seconds or longer. Release it when the display turns to "LoL".

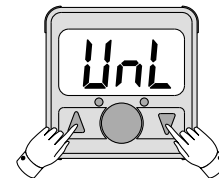

Display "UnL" by pressing ▲ button or ▼ button.

- **Peak mode** ----- Allows holding of the maximum pressure value on display under measurement.

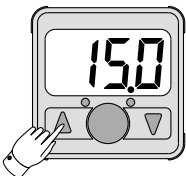

While displayed, pressing the ▲ button for 1 second or longer causes the peak mode to display and blink. Pressing the ▲ button once again for 1 second or longer reinstates it.
(Note) Displaying the peak and the bottom display is not distinguished.

- **Bottom mode** ----- Allows holding of the minimum pressure value on display under measurement.



While displayed, pressing the ▼ button for 1 second or longer causes the bottom mode to display and blink. Pressing the ▼ button once again for 1 second or longer reinstates it.
(Note) Displaying the peak and the bottom display is not distinguished.

- **Zero clear** ----- Allows an adjust to zero on the display if the pressure to be measured is within a range of ±70 digits from the atmospheric pressure.

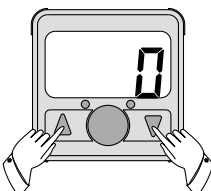

Pressing the ▲ + ▼ buttons simultaneously with the supply pressure released to the atmosphere, causes it to reset to zero on the display and completes the zero clear operation. The function then returns to the measurement mode.

High Precision, Digital Pressure Switch Series ZSE40/ISE40

Dimensions

ZSE40(F)/ISE40-01

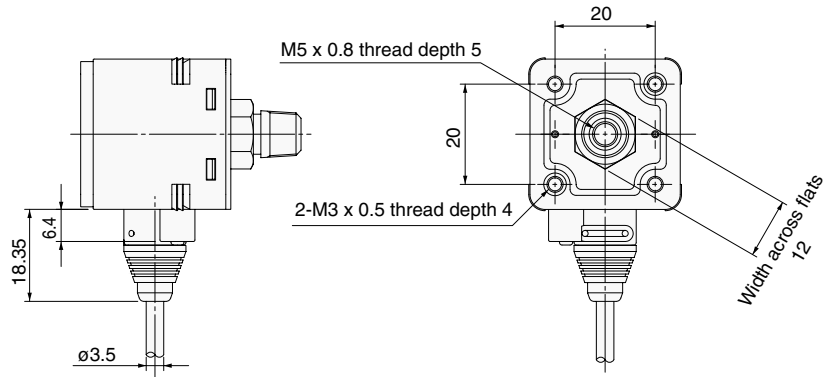
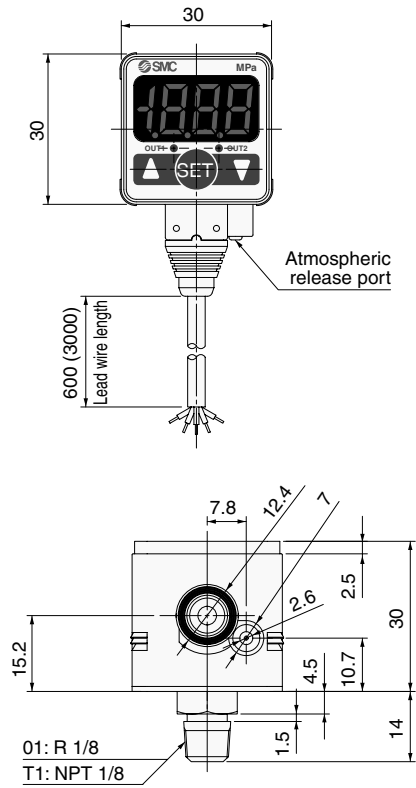
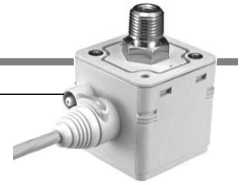

* For splash proof use (IP65), insert an air tube into the atmospheric release port.
(Refer to "Precautions" on page 16-2-24 for details.)

ZSE40(F)/ISE40-W1

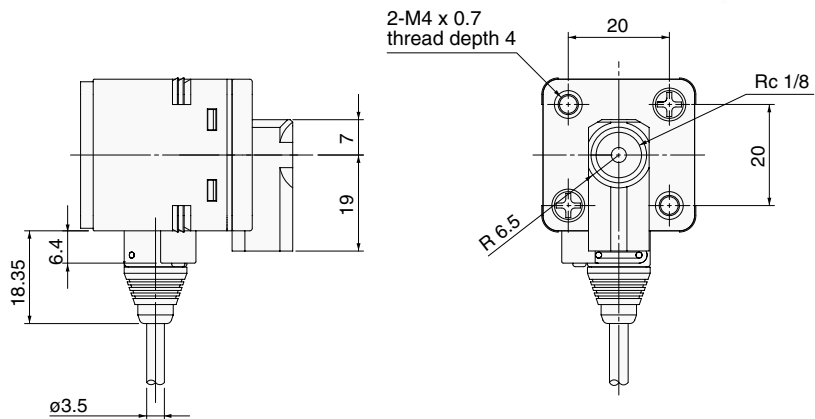
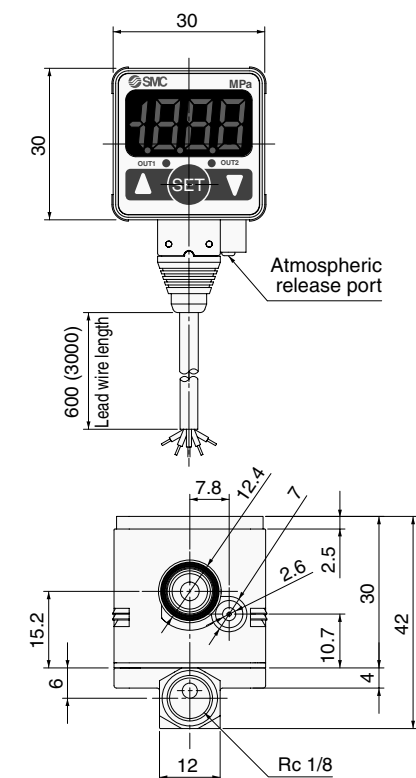
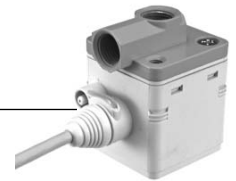

* For splash proof use (IP65), insert an air tube into the atmospheric release port.
(Refer to "Precautions" on page 16-2-24 for details.)

- ZSE□
- ISE□
- PSE
- ZSE3
- PS
- ZSE1₂
- ZSP
- ISA2
- IS□
- ZSM
- PF2□
- IF□
- Data

Series ZSE40/ISE40

Dimensions

ZSE40(F)/ISE40— C4
C6
M5

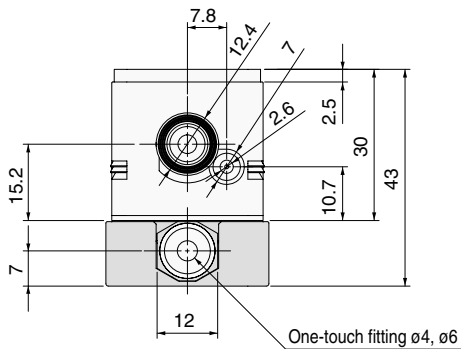
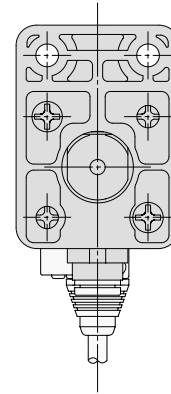
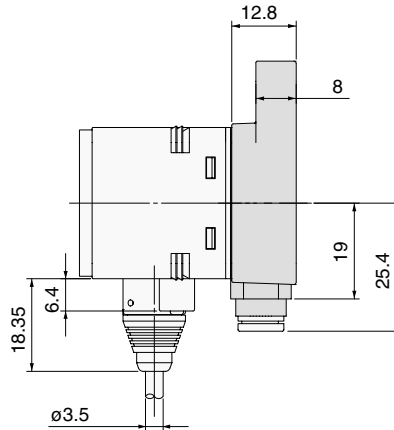
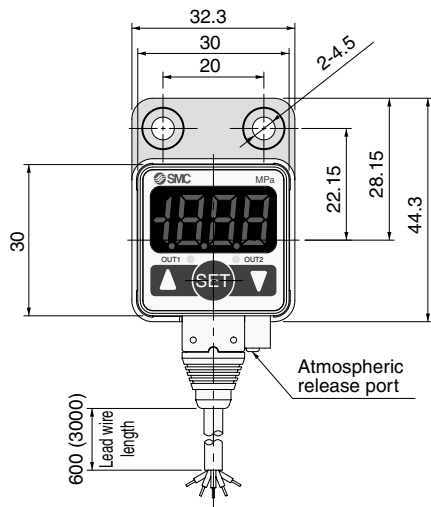

For—M5

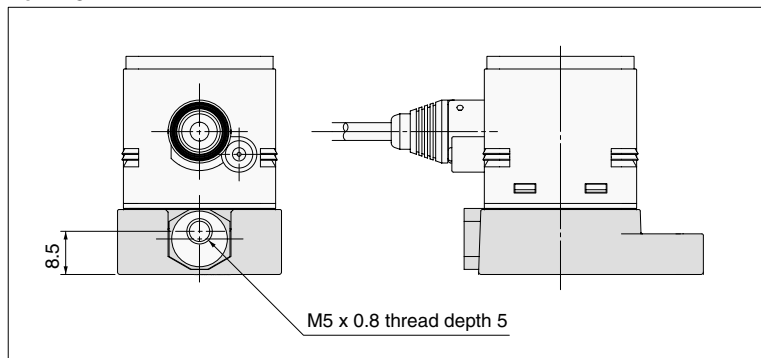

* For splash proof use (IP65), insert an air tube into the atmospheric release port.
(Refer to "Precautions" for details.)

⚠ Precautions

⚠ Caution

1. Immediately after supplying power, there is drift of about $\pm 0.5\%$ F.S. When used with very low pressure, allow the unit to warm up for about 20 to 30 minutes.
2. Do not use in locations where there is splashing or spraying of oils and solvents.
3. When using a commercially available switching regulator, be sure to ground the FG terminal.
4. In locations where the switch is exposed to water and dust, etc., these may enter the switch from the atmospheric release port. Insert $\phi 4$ tubing (inside diameter $\phi 2.5$) into the atmospheric release port, and extend the other end to a safe area where water, etc., is not splashed or sprayed. Be sure that tubing is not bent and holes are not blocked, etc., or it will become impossible to make correct pressure measurements.

