

Mono 1.1W Power Amplifier with Shutdown, Low Voltage Operation

FEATURES

- Operation range: 2.5V ~ 6.5V
- Shutdown Current 0.1uA at 6V
- PSRR at 217Hz, 60dB at 5V
- Output power, THD+N=1%
 $R_L=8\Omega$, 1.5W at 6V, 1.1W at 5V, 0.4W at 3.3V, 200mW at 2.5V
- Unity-gain stable
- Space-saving SOP8, MSOP8

APPLICATIONS

- Portable electronic devices
- PDAs
- Communication headsets

Cross-reference

LM4891

DESCRIPTION

The MS6891 is a low distortion power amplifier that can drive 1.5W (6V) of continuous average power into a mono 8Ω bridged-tied load (BTL). Operation with 2.5V supply, it can drive 200mw into a mono 8Ω. The BTL configuration eliminates the need for external coupling capacitors on the output in most applications. The MS6891 is unity-gain stable and can be configured by external gain-setting resistors.

The MS6891 has good feature for portable equipment, these features include the low voltage operation, micropower consumption shutdown mode, small package SOP8, MSOP8, make the MS6891 ideally suited for use in portable electronic equipments.

BLOCK DIAGRAM

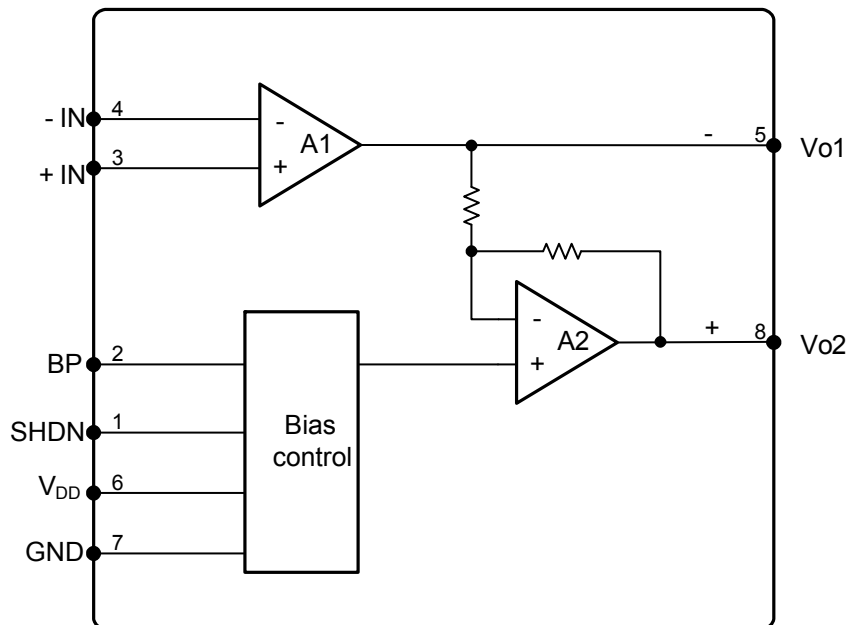

PIN CONFIGURATION

Symbol	Pin	Description
SHDN	1	Shutdown places the entire device in shutdown mode when held High. TTL compatible input.
BP	2	Bypass is the cap to the voltage divider for internal mid-supply bias. This terminal should be connected to a 0.1- μ F to 10- μ F capacitor C_{BP} .
+IN	3	Non-inverting input
-IN	4	Inverting input
Vo1	5	BTL negative output
V _{DD}	6	Supply voltage
GND	7	Ground
Vo2	8	BTL positive output

SOP8, MSOP8

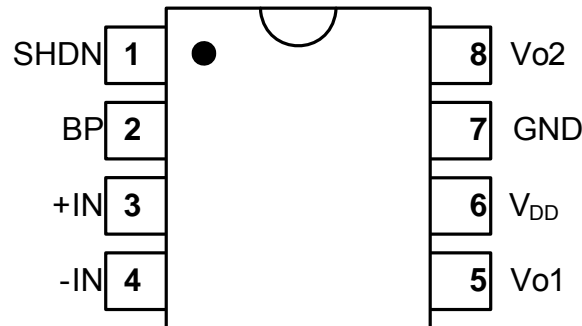

ORDERING INFORMATION

Package	Part number	Packaging Marking	Transport Media
8-Pin SOP (lead free)	MS6891GTR	6891G	2.5k Units Tape and Reel
8-Pin SOP (lead free)	MS6891GU	6891G	100 Units Tube
8-Pin MSOP (lead free)	MS6891MGTR	6891G	3.5k Units Tape and Reel
8-Pin MSOP (lead free)	MS6891MGU	6891G	80 Units Tube

ABSOLUTE MAXIMUM RATINGS

Symbol	Parameter	Rating	Unit
V _{DD}	Supply voltage	6.5	V
V _{ESD}	Electrostatic handling	3500	V
T _{STG}	Storage temperature range	-65 to 150	°C
T _A	Operating ambient temperature range	-40 to 85	°C
T _J	Maximum junction temperature	150	°C
T _S	Soldering temperature, 10 seconds	260	°C
R _{THJA}	Thermal resistance from junction to ambient in free air SOP8 MSOP8	210 50	°C/W

OPERATING RATINGS

Symbol	Parameter	Min	Typ	Max	Unit
V _{DD}	Supply voltage	2.5	5	6.5	V

6V ELECTRICAL CHARACTERISTICS

T_a = 25°C, V_{DD}=6V, f=1kHz, BW<30kHz, unless otherwise specified.

Symbol	Parameter	Conditions	Min	Typ	Max	Unit
I _Q	Quiescent current	V _{IN} =0V, I _O =0A	-	3	-	mA
I _{SHDN}	Shutdown current	V _{SHDN} = 6V	-	0.1	-	uA
V _{SDH}	Shutdown input voltage high		2.0	-	-	V
V _{SDL}	Shutdown input voltage low		-	-	0.8	V
PSRR	Power supply rejection ratio	R _L =8Ω, C _{BP} =1uF, f=217Hz	-	55	-	dB
THD+N	Total harmonic distortion plus noise	R _L =8Ω, 1.5W	-	-54	-50	dB
			-	0.2	0.316	%
S/N	Signal-to-noise ratio	R _L =8Ω, 1.5W	95	108	-	dB
P _o	Output power	R _L =8Ω, THD+N = 1%	-	1.5	-	W

5V ELECTRICAL CHARACTERISTICS

T_a = 25°C, V_{DD}=5V, f=1kHz, BW<30kHz, unless otherwise specified.

Symbol	Parameter	Conditions	Min	Typ	Max	Unit
I _Q	Quiescent current	V _{IN} =0V, I _O =0A	-	2.6	-	mA
I _{SHDN}	Shutdown current	V _{SHDN} =5V	-	0.1	-	uA
PSRR	Power supply rejection ratio	R _L =8Ω, C _{BP} =1uF, f=217Hz	-	60	-	dB
THD+N	Total harmonic distortion plus noise	R _L =8Ω, 1.1W	-	-54	-50	dB
			-	0.2	0.316	%
S/N	Signal-to-noise ratio	R _L =8Ω, 1.1W	90	103	-	dB
P _o	Output power	R _L =8Ω, THD+N = 1%	-	1.1	-	W

3.3V ELECTRICAL CHARACTERISTICS

T_a = 25°C, V_{DD}=3.3V, f=1kHz, BW<30kHz, unless otherwise specified.

Symbol	Parameter	Conditions	Min	Typ	Max	Unit
I _Q	Quiescent current	V _{IN} =0V, I _O =0A	-	2.3	-	mA
I _{SD}	Shutdown current	V _{SHDN} =3.3V	-	0.1	-	uA
PSRR	Power supply rejection ratio	R _L =8Ω, C _{BP} =1uF, f=217Hz	-	60	-	dB
THD+N	Total harmonic distortion plus noise	R _L =8, 0.4W	-	-55	-50	dB
			-	0.17	0.316	%
S/N	Signal-to-noise ratio	R _L =8Ω, 0.4W	90	100	-	dB
P _o	Output power	R _L =8Ω, THD+N = 1%	-	0.4	-	W

2.5V ELECTRICAL CHARACTERISTICS

Ta = 25°C, V_{DD}=2.5V, f=1kHz, BW<30kHz, unless otherwise specified.

Symbol	Parameter	Conditions	Min	Typ	Max	Unit
I _Q	Quiescent current	V _{IN} =0V, I _O =0A	-	2.2	-	mA
I _{SD}	Shutdown current	V _{SHDN} =2.5V	-	0.1	-	uA
PSRR	Power supply rejection ratio	R _L =8Ω, C _{BP} =1uF, f=217Hz	-	60	-	dB
THD+N	Total harmonic distortion plus noise	R _L =8Ω, 0.2W	-	-55	-50	dB
			-	0.17	0.316	%
S/N	Signal-to-noise ratio	R _L =8Ω, 0.2W	90	98	-	dB
P _o	Output power	R _L =8Ω, THD+N = 1%	-	0.2	-	W

TYPICAL PERFORMANCE CHARACTERISTICS

Ta = 25°C, BW<30kHz, unless otherwise specified.

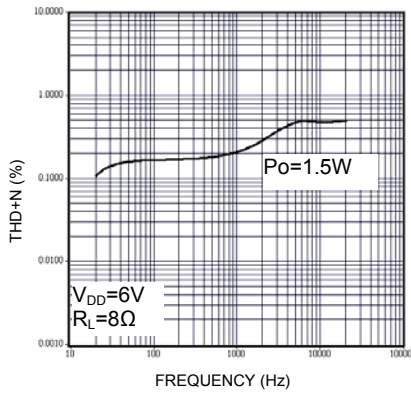

THD+N vs. frequency

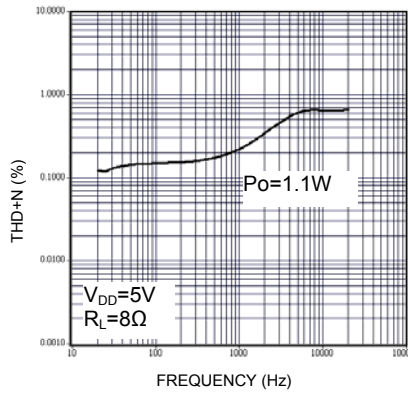

THD+N vs. frequency

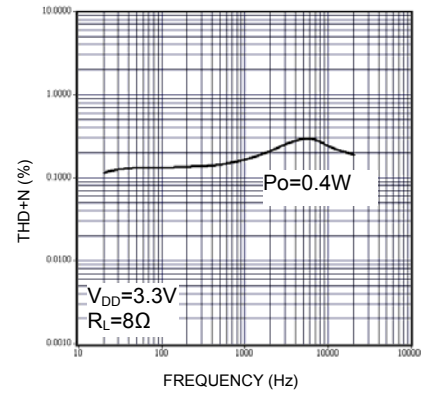

THD+N vs. frequency

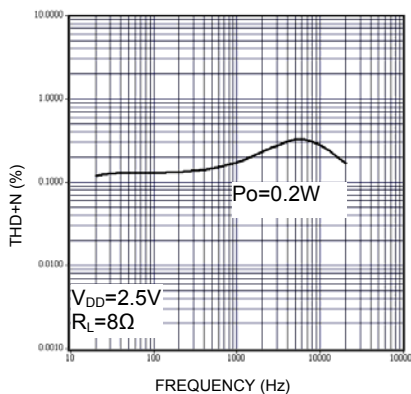

THD+N vs. frequency

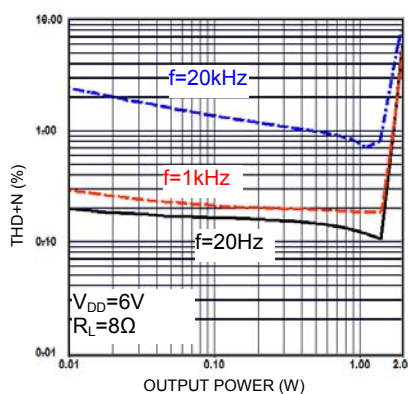

THD+N vs. output power

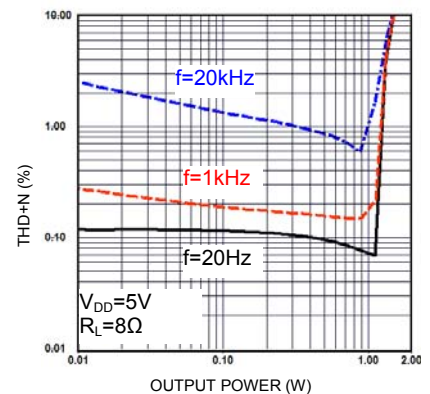

THD+N vs. output power

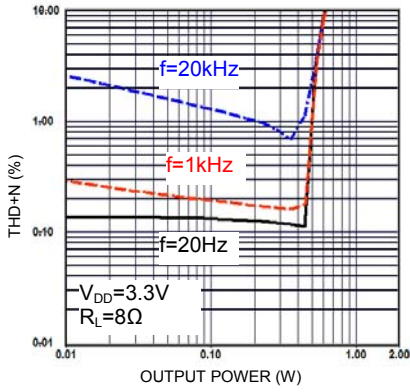

THD+N vs. output power

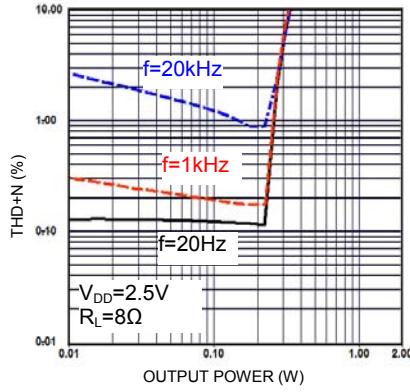

THD+N vs. output power

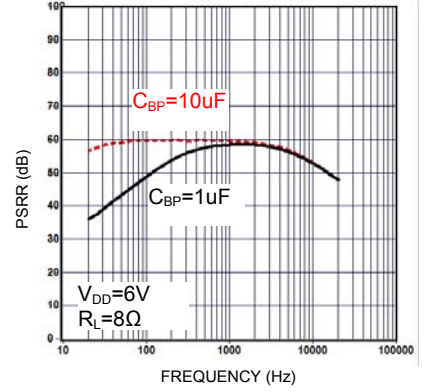

PSRR vs. frequency

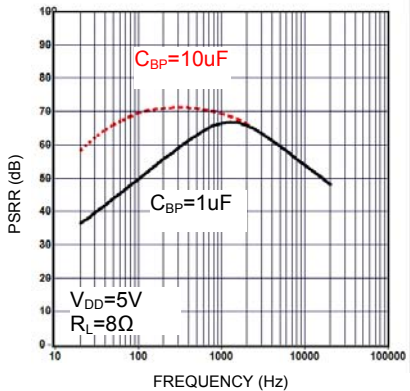

PSRR vs. frequency

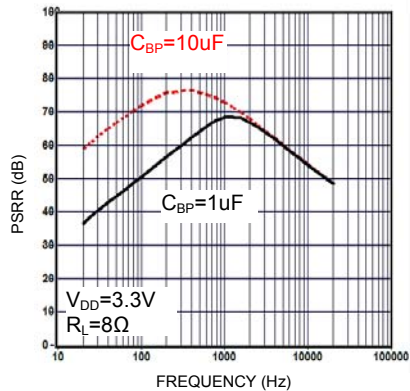

PSRR vs. frequency

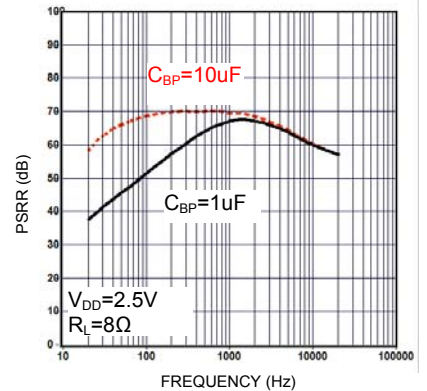

PSRR vs. frequency

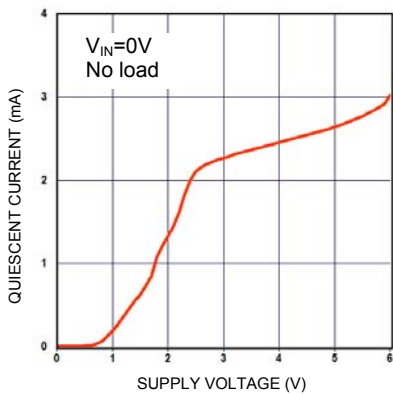

Quiescent current vs. supply voltage

APPLICATION INFORMATION

Basic application example

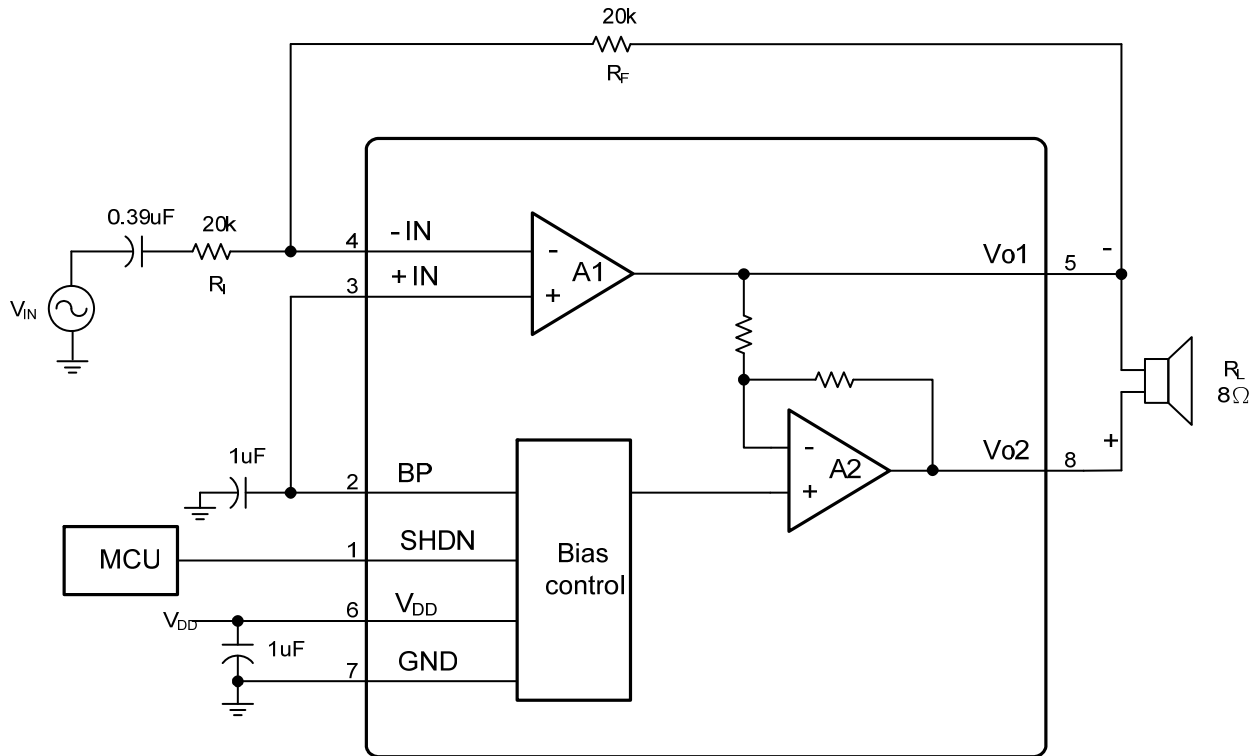

Fig.1 A audio amplifier application circuit.

External gain-setting

As shown in Fig.1, The amplifier A1 is independent amplifiers with an externally configured gain of $A_V = - R_F/R_{IN}$. The amplifier A2 is a closed-loop gain of $A_V = -1$ fixed by two internal resistors. The outputs of A1 and A2 are used to drive the mono bridged-tied load (BTL).

High Pass Filter

The input capacitor C_{IN} and resistor R_{IN} are decided the cut-off frequency of the HPF. The equation is as follows:

$$f_{\text{cut-off}} = 1 / (2 \pi * R_{IN} * C_{IN})$$

EXTERNAL DIMENSIONS

SOP8

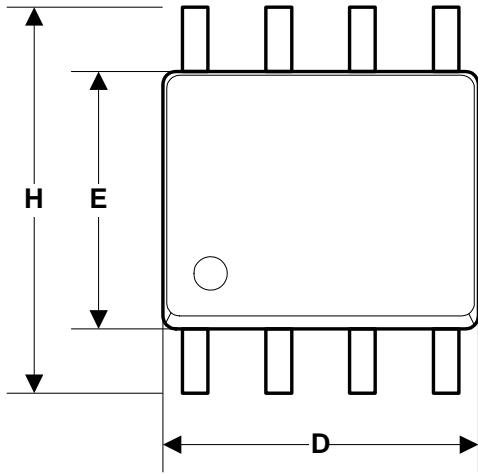

Symbol	Dimension in mm		Dimension in inch	
	Min	Max	Min	Max
A	1.35	1.75	0.0532	0.0688
A1	0.10	0.25	0.0040	0.0098
B	0.33	0.51	0.013	0.020
C	0.19	0.25	0.0075	0.0098
D	4.80	5.00	0.1890	0.1968
H	5.80	6.20	0.2284	0.2440
E	3.80	4.00	0.1497	0.1574
e	1.27 BSC		0.050 BSC	
L	0.40	1.27	0.016	0.050

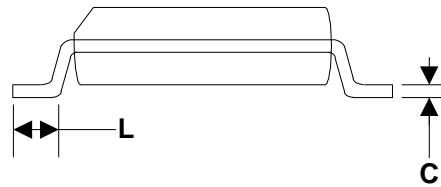
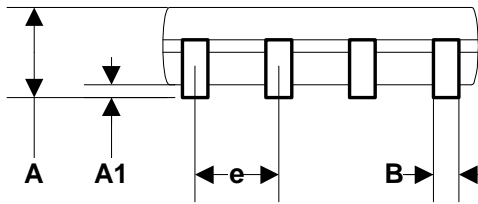

MSOP8

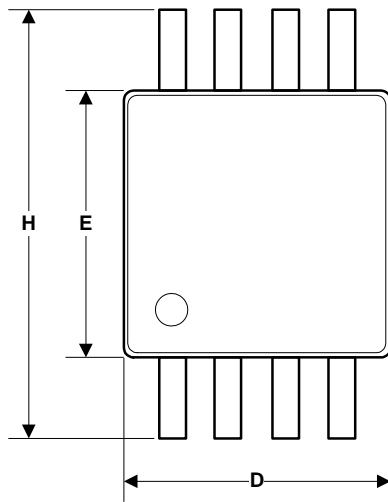

Symbol	Dimension in mm		Dimension in inch	
	Min	Max	Min	Max
A	0.81	1.12	0.032	0.048
A1	0.05	0.15	0.002	0.006
A2	0.76	0.86	0.030	0.038
B	0.28	0.38	0.011	0.015
C	0.13	0.23	0.005	0.009
D	2.90	3.10	0.114	0.122
H	4.70	5.10	0.185	0.201
E	2.90	3.10	0.114	0.122
e	0.65		0.026	
L	0.40	0.66	0.016	0.026

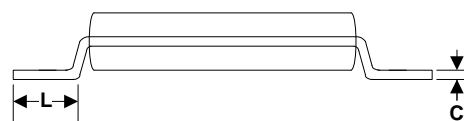
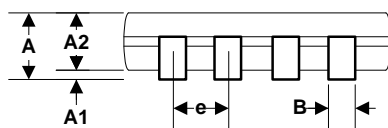

TAPE AND REEL (Unit : mm)

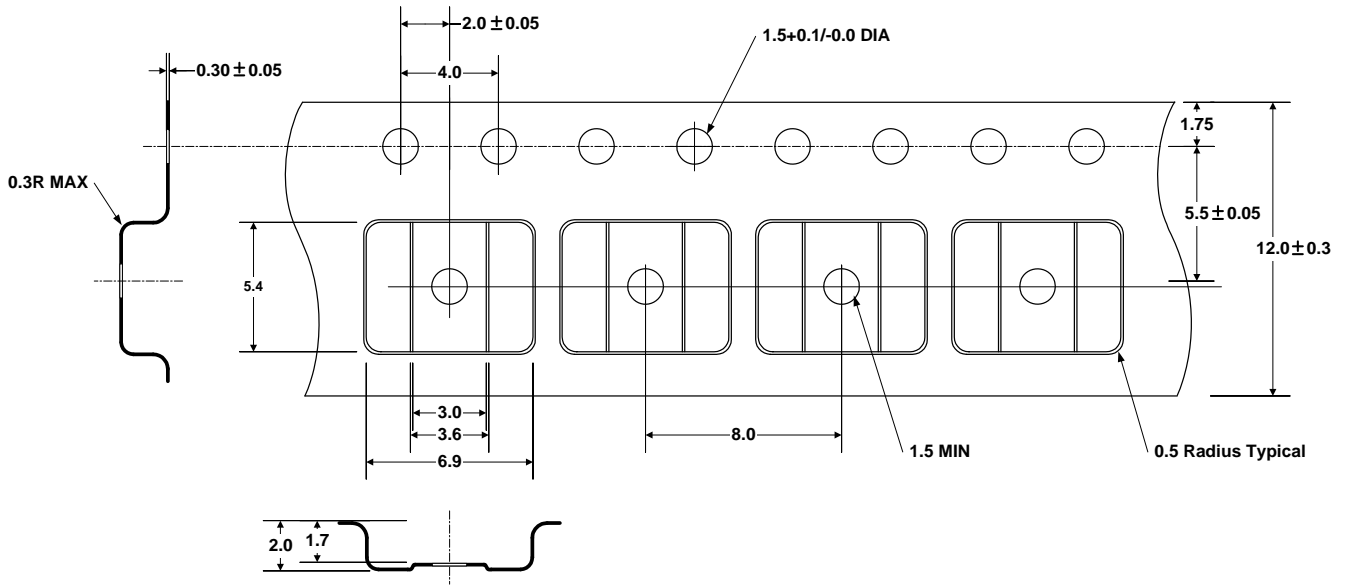

SOP8

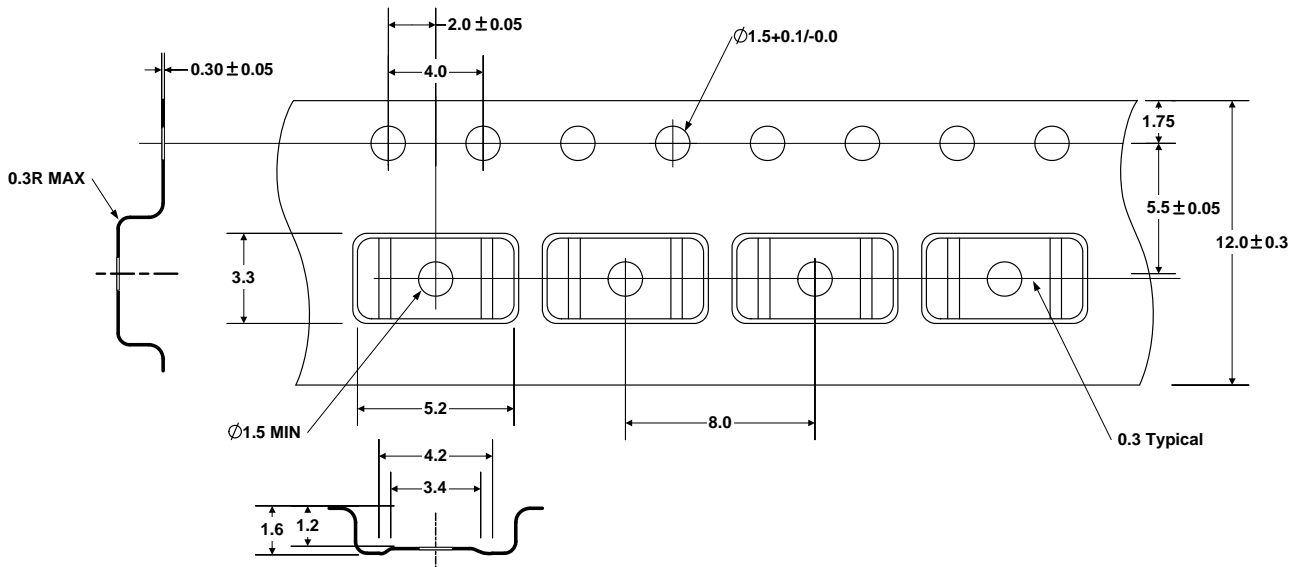

MSOP8

DEMO BOARD

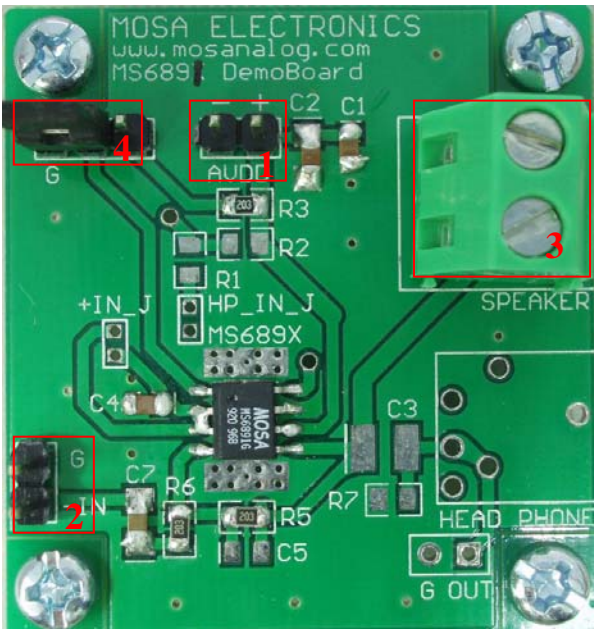

Function description

Label 1: Supply Voltage

Supply voltage range is 2.5V to 6.5V, the left of jumper is positive and the right of jumper is negative.

Label 2: Signal Input

Connected to audio signals.

Label 3: Speaker Output

Connected to speaker with 8ohm or 4 ohm

Label 4: Shutdown Control

The system is active mode when the jumper is placed left, the shutdown pin of MS6891 is connected to GND.
The system enters shutdown mode when the jumper is placed right, the shutdown pin of MS6891 is connected to V_{DD} .

Circuit

