

Features

- Efficiency up to 93%
- 180µA(TYP.) Quiescent Current
- Output Current: Up to 1A
- Internal Synchronous Rectifier
- 1.5MHz Switching Frequency
- Soft Start
- Under-Voltage Lockout
- Short LED Protection
- Open LED Protection
- Thermal Shutdown
- 5-pin Small SOT23-5 Packages
- Pb-Free Package

Applications

- 3AA or 4AA Batteries Powered Flashlight
- 1 Cell Li-Ion Battery Powered Flashlight

General Description

The PAM2804 is a step-down constant current LED driver. When the input voltage down to lower than LED forward voltage, then PAM2804 run into LDO mode.

The PAM2804 supports a range of input voltages from 2.5V to 6.0V, allowing the use of a single Li+/Li-polymer cell, 3AA or 4AA cell, USB, and other standard power sources.

The FB voltage is only 0.1V to achieve high efficiency.

PAM2804 employ internal power switch and synchronous rectifier to minimize external part count and realize high efficiency.

During shutdown, the input is disconnected from the output and the shutdown current is less than 1µA. Other key features include under-voltage lockout to prevent deep battery discharge of the Li+ battery.

Typical Application

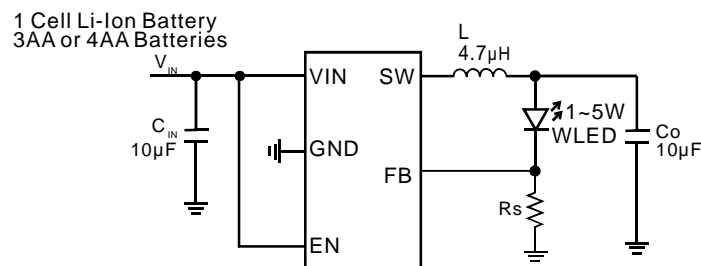

$$I_{LED} = 0.1/R_s$$

Block Diagram

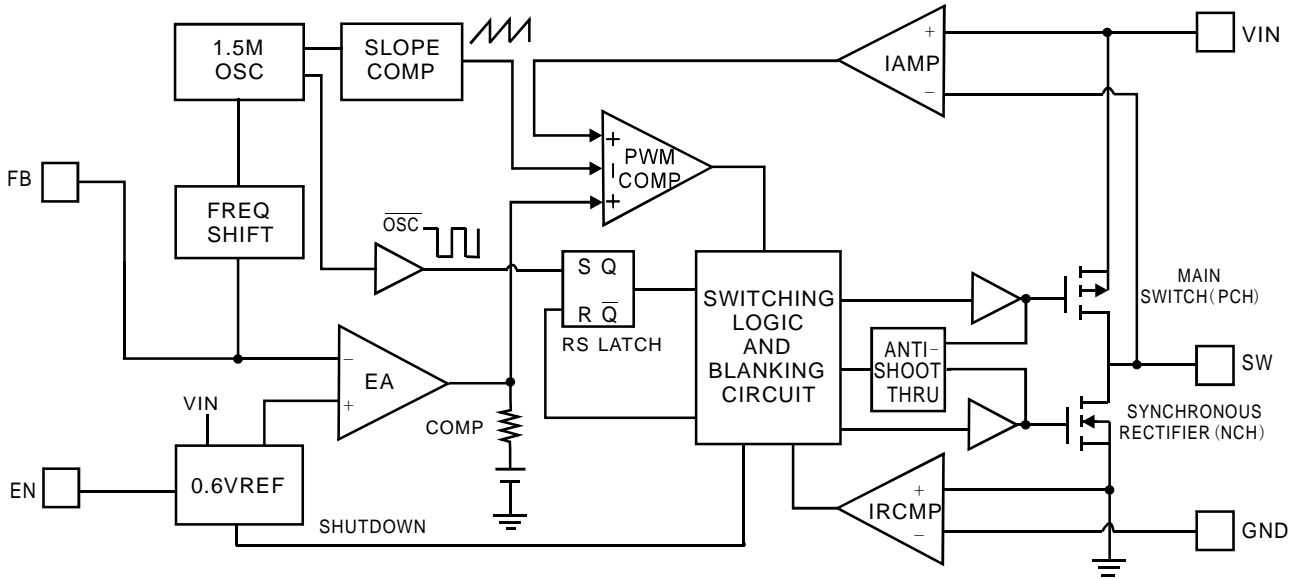

Pin Configuration & Marking Information

Top View
SOT23-5

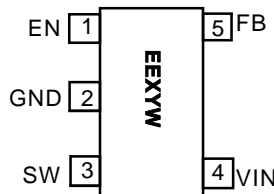

EE: Product Code of PAM2804
X: Internal Code
Y: Year
W: Week

Pin Description

Name	Function
VIN	Chip main power supply pin
GND	Ground
EN	Enable control input. Force this pin voltage above 1.5V, enables the chip, and below 0.3V shuts down the device.
FB	Feedback voltage to internal error amplifier, the threshold voltage is 0.1V.
SW	The drains of the internal main and synchronous power MOSFET.



Absolute Maximum Ratings

These are stress ratings only and functional operation is not implied. Exposure to absolute maximum ratings for prolonged time periods may affect device reliability. All voltages are with respect to ground.

Input Voltage.....	-0.3V to 6.5V	Junction Temperature.....	150°C
EN, FB Pin Voltage.....	-0.3V to V_{IN}	Storage Temperature Range.....	-65°C to 150°C
SW Pin Voltage.....	-0.3V to ($V_{IN}+0.3V$)	Soldering Temperature.....	300°C, 5sec

Recommended Operating Conditions

Supply Voltage.....	2.5V to 6.0V	Junction Temperature Range.....	-40°C to 125°C
Operation Temperature Range.....	-40°C to 85°C		

Thermal Information

Parameter	Package	Symbol	Maximum	Unit
Thermal Resistance (Junction to Case)	SOT23-5 ^{Note}	θ_{JC}	130	°C/W
Thermal Resistance (Junction to Ambient)	SOT23-5	θ_{JA}	250	
Internal Power Dissipation	SOT23-5	P_D	400	mW

Note:

The maximum output current for SOT23-5 package is limited by internal power dissipation capacity as described in Application Information herein after.



Electrical Characteristic

$T_A=25^{\circ}\text{C}$, $V_{IN}=4.2\text{V}$, Real WLED load, $C_{IN}=10\mu\text{F}$, $C_O=10\mu\text{F}$, $L=4.7\mu\text{H}$, unless otherwise noted.

PARAMETER	SYMBOL	Test Conditions	MIN	TYP	MAX	UNITS	
Input Voltage Range	V_{IN}		2.5		6.0	V	
Regulated Feedback Voltage	V_{FB}		0.095	0.1	0.105	V	
Peak Inductor Current	I_{PK}	$V_{IN}=5\text{V}$		1.5		A	
Quiescent Current	I_Q	No load		180		μA	
Shutdown Current	I_{SD}	$V_{EN} = 0\text{V}$			1	μA	
Oscillator Frequency	f_{OSC}	$V_O = 100\%$	1.2	1.5	1.8	MHz	
Drain-Source On-State Resistance	$R_{DS(ON)}$	$I_{DS}=100\text{mA}$	P MOSFET		0.3	0.45	Ω
			N MOSFET		0.35	0.5	Ω
SW Leakage Current	I_{LSW}			± 0.01	1	μA	
High Efficiency	η			93		%	
EN Threshold High	V_{EH}		1.5			V	
EN Threshold Low	V_{EL}				0.3	V	
EN Leakage Current	I_{EN}			± 0.01		μA	
Over Temperature Protection	OTP			150		$^{\circ}\text{C}$	
OTP Hysteresis	OTH			30		$^{\circ}\text{C}$	

Typical Performance Characteristics

$T_A=25^\circ\text{C}$, $C_{IN}=10\mu\text{F}$, $C_O=10\mu\text{F}$, $L=4.7\mu\text{H}$, unless otherwise noted.

Efficiency VS Input Voltage

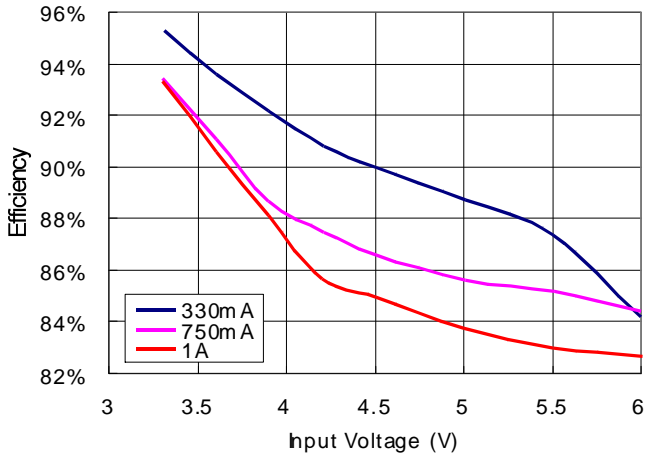

Output Current VS Input Voltage

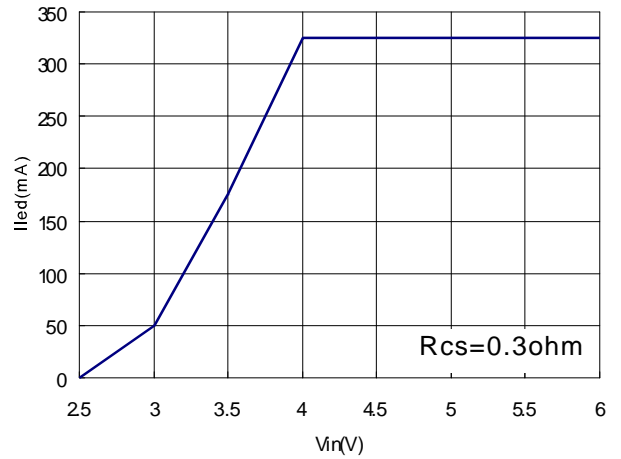

Output Current VS Input Voltage

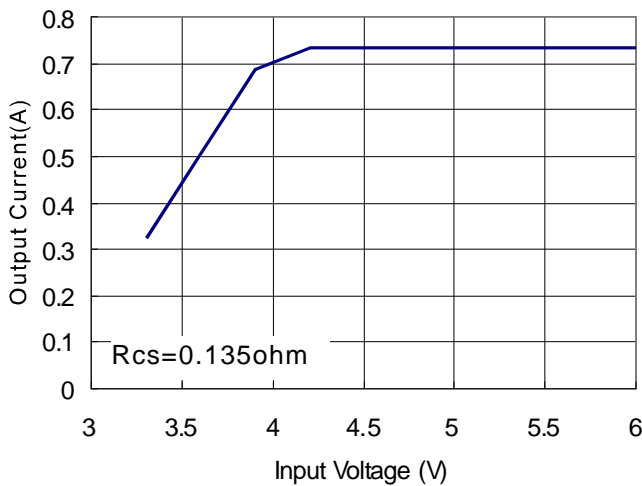

Output Current VS Input Voltage

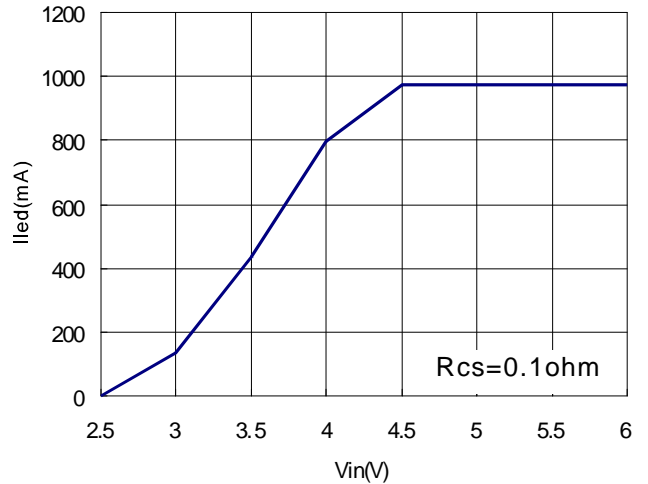

Rdson VS Input Voltage

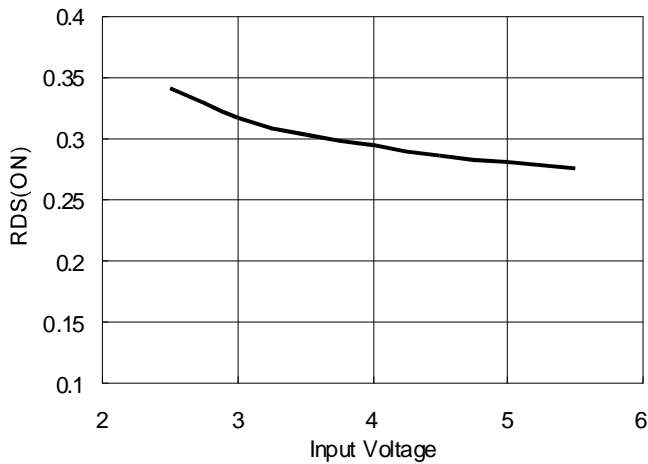

Rdson VS Temperature

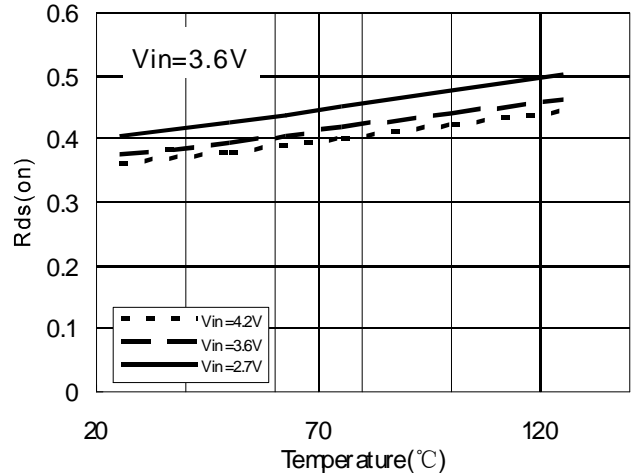

Typical Performance Characteristics

$T_A=25^\circ\text{C}$, $C_{IN}=10\mu\text{F}$, $C_O=10\mu\text{F}$, $L=4.7\mu\text{H}$, unless otherwise noted.

Quiescent Current Vs Input Voltage

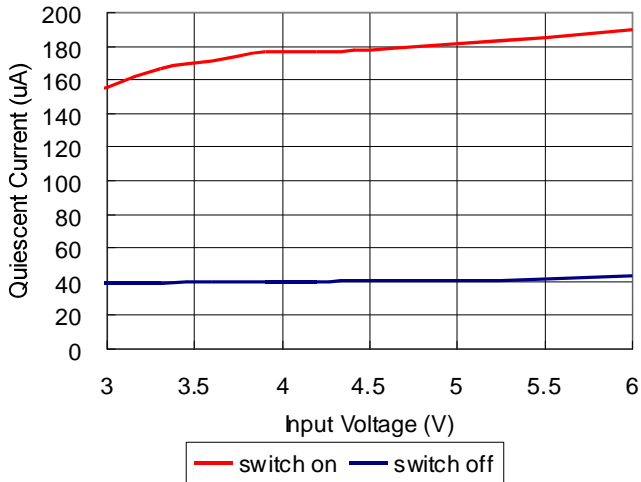

Start up with Enable



Application Information

The basic PAM2804 application circuit is shown in Page 1. External component selection is determined by the load requirement, selecting L first and then Cin and Cout.

Inductor Selection

For most applications, the value of the inductor will fall in the range of 1μH to 4.7μH. Its value is chosen based on the desired ripple current. Large value inductors lower ripple current and small value inductors result in higher ripple currents. Higher V_{IN} or V_{OUT} also increases the ripple current as shown in equation 1. A reasonable starting point for setting ripple current is $\Delta I_L = 400\text{mA}$ (40% of 1A).

$$\Delta I_L = \frac{1}{(f)(L)} V_{OUT} \left(1 - \frac{V_{OUT}}{V_{IN}} \right) \quad (1)$$

The DC current rating of the inductor should be at least equal to the maximum load current plus half the ripple current to prevent core saturation. Thus, a 1.4A rated inductor should be enough for most applications (1A + 400mA). For better efficiency, choose a low DC-resistance inductor.

Using Ceramic Input and Output Capacitors

Higher values, lower cost ceramic capacitors are now becoming available in smaller case sizes. Their high ripple current, high voltage rating and low ESR make them ideal for switching regulator applications. Using ceramic capacitors can achieve very low output ripple and small circuit size.

When choosing the input and output ceramic capacitors, choose the X5R or X7R dielectric formulations. These dielectrics have the best temperature and voltage characteristics of all the ceramics for a given value and size.

Thermal consideration

Thermal protection limits power dissipation in the PAM2804. When the junction temperature exceeds 150°C, the OTP (Over Temperature Protection) starts the thermal shutdown and turns the pass transistor off. The pass transistor resumes operation after the junction temperature drops below 120°C.

For continuous operation, the junction

temperature should be maintained below 125°C. The power dissipation is defined as:

$$P_D = I_O^2 \frac{V_O R_{DS(ON)H} + (V_{IN} - V_O) R_{DS(ON)L}}{V_{IN}} + (t_{SW} F_S I_O + I_Q) V_{IN}$$

I_Q is the step-down converter quiescent current. The term t_{sw} is used to estimate the full load step-down converter switching losses.

Application Information

For the condition where the step-down converter is in dropout at 100% duty cycle, the total device dissipation reduces to:

$$P_D = I_O^2 R_{DS(ON)} + I_Q V_{IN}$$

Since $R_{DS(ON)}$, quiescent current, and switching losses all vary with input voltage, the total losses should be investigated over the complete input voltage range. The maximum power dissipation depends on the thermal resistance of IC package, PCB layout, the rate of surrounding airflow and temperature difference between junction and ambient. The maximum power dissipation can be calculated by the following formula:

$$P_D = \frac{T_{J(MAX)} - T_A}{\theta_{JA}}$$

Where $T_{J(max)}$ is the maximum allowable junction temperature 125°C. T_A is the ambient temperature and θ_{JA} is the thermal resistance from the junction to the ambient. Based on the standard JEDEC for a two layers thermal test board, the thermal resistance θ_{JA} of SOT23-5 package is 250°C/W. The maximum power dissipation at $T_A = 25^\circ\text{C}$ can be calculated by following formula:

$$P_D = (125^\circ\text{C} - 25^\circ\text{C}) / 250^\circ\text{C/W} = 0.4\text{W}$$

Setting the Output Current

The internal feedback (FB) voltage is 0.1V (Typical). The output current is calculated as below:

$$I_{LED} = 0.1 / R_s$$

The output Current is given by the following table.

$R_s(\Omega)$	$I_{LED}(\text{mA})$
0.286	350
0.143	700
0.1	1000

100% Duty Cycle Operation

As the input voltage approaches the LED forward voltage, the PAM2804 turns the P-channel transistor continuously on. In this mode the Voltage drop on LED is equal to the input voltage minus the voltage drop across the P - channel transistor, Inductor and current resistor:

$$V_{LEDDROP} = V_{IN} - I_{LED} (R_{ds(on)} + R_L + R_s)$$

where $R_{ds(on)}$ = P-channel switch ON resistance, I_{LED} = LED current, R_L = Inductor DC resistance, R_s = Inductor DC resistance.

Thermal Shutdown

When the die temperature exceeds 150°C, a reset occurs and the reset remains until the temperature decrease to 120°C, at which time the circuit can be restarted.



Application Information

PCB Layout Check List

When laying out the printed circuit board, the following checklist should be used to ensure proper operation of the PAM2804. These items are also illustrated graphically in Figure 1. Check the following in your layout:

1. The power traces, consisting of the GND trace, the SW trace and the VIN trace should be kept short, direct and wide.
2. Does the V_{FB} pin connect directly to the current sense resistor? The current sense resistor to GND trace should be kept short, direct and wide.
3. Does the (+) plate of C_{IN} connect to VIN as closely as possible? This capacitor provides the AC current to the internal power MOSFETs.
4. Keep the switching node, SW, away from the sensitive VFB node.
5. Keep the (-) plates of C_{IN} and C_{OUT} as close as possible.



Ordering Information

PAM 2804 X X X XXX

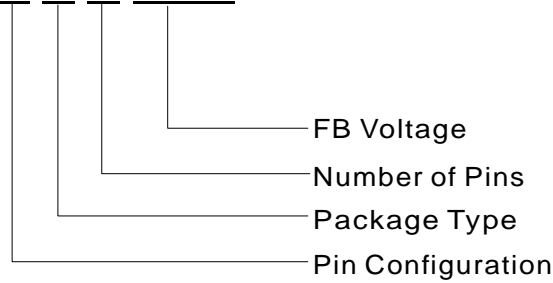

Pin Configuration	Package Type	Number of Pins	FB Voltage
A Type 1. EN 2. GND 3. SW 4. VIN 5. FB	A: SOT-23	B: 5	010: 0.1V

Part Number	Marking	Package Type	Standard Package
PAM2804AAB010	Refer to P2	SOT-23-5	3,000Units/Tape&Reel

Outline Dimensions

SOT23-5

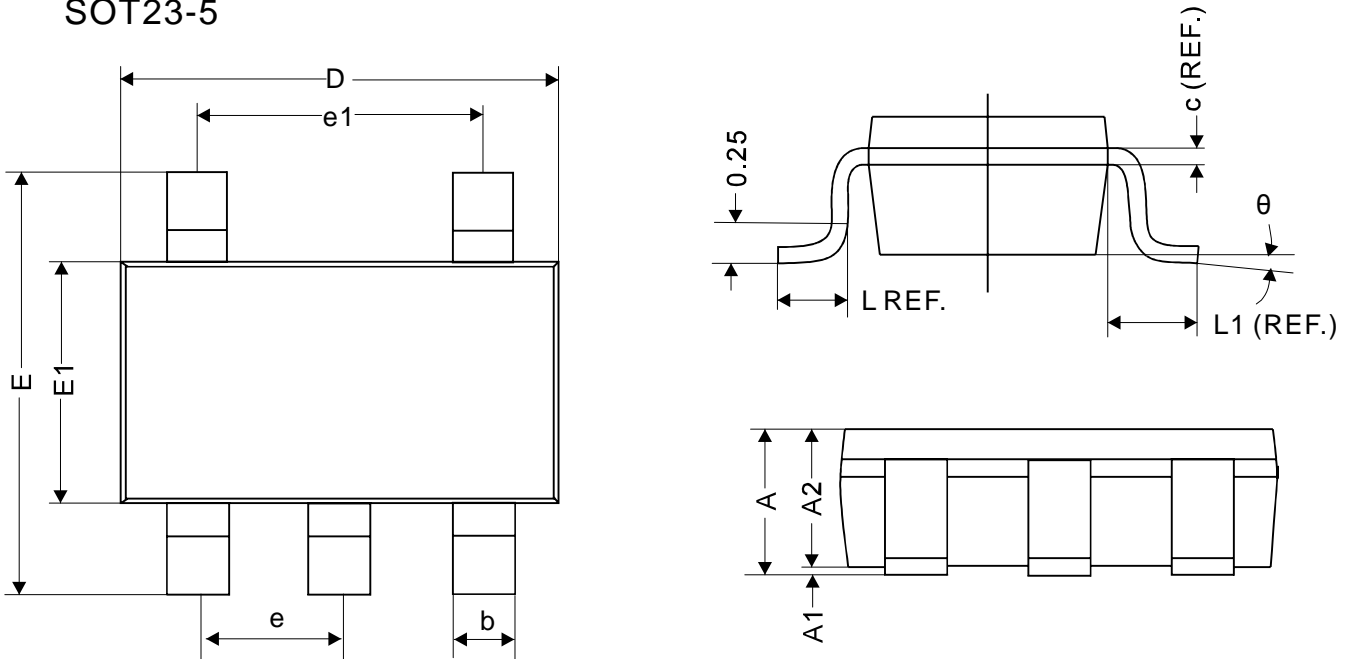

REF.	Millimeter	
	Min	Max
A	1.10 MAX	
A1	0	0.10
A2	0.70	1
c	0.12 REF.	
D	2.70	3.10
E	2.60	3.00
E1	1.40	1.80
L	0.45 REF.	
L1	0.60 REF.	
θ	0°	10°
b	0.30	0.50
e	0.95 REF.	
e1	1.90 REF.	