

## Water- and Environment-resistive FA Connectors Save Wiring and Maintenance Effort

- Compact FA connectors meet IP67 requirements and ensure a 94V-0 fire retardant rating.
- A wide array of connectors makes a wiring system more modular, simplifies maintenance, and reduces downtime.
- Connectors with Cables and Connector Assemblies are available.
- Three types of Connector Assembly: Crimping, soldering, and screw-on.
- Connectors with Cables are UL certified.
- Based on IEC61076-2-101 (IEC 60947-5-2) and NECA 4202.



Refer to *Safety Precautions* on page 26.

## Construction (XS2G Soldering Connector Plug Assemblies)

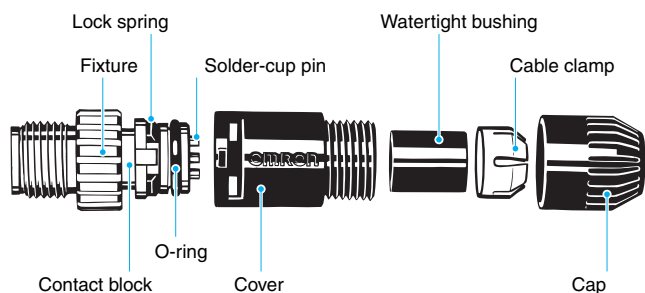

## Ratings and Specifications

<b>Rated current</b>	3 A
<b>Rated voltage</b>	For DC 125 VDC, for AC 250 VAC
<b>Contact resistance (Connector)</b>	40 mΩ max. (20 mV max., 100 mA max.)
<b>Insulation resistance</b>	1,000 MΩ min. (at 500 VDC)
<b>Dielectric strength (Connector)</b>	1,500 VAC for 1 min (leakage current: 1 mA max.)
<b>Degree of protection</b>	IP67 (IEC529)
<b>Insertion tolerance</b>	200 times min.
<b>Assembled fixture strength</b>	Tensile: 98 N/15 s Torsion: 0.98 N·m/15 s
<b>Cable holding strength</b>	Cable diameter: 6 mm 98 N/15 s 4 to 5 mm 49 N/15 s 3 mm 29 N/15 s
<b>Ambient operating temperature range</b>	Operating: -25°C to 70°C
<b>Ambient humidity range</b>	20% to 85%

## Recommended Cables

Cable outer diameter	Core sizes		
	Crimping models	Soldering models	Screw-on models
8 mm	7 to 8 mm	---	---
7 mm	6 to 8 mm	---	---
6 mm	5 to 6 mm	Two types of contacts are available. • 0.18 to 0.3 mm <sup>2</sup> • 0.5 to 0.75 mm <sup>2</sup>	0.18 to 0.75 mm <sup>2</sup>
4 mm	4 to 5 mm		
3 mm	3 to 4 mm		

## Materials and Finish

Item	XS2F/H/W	XS2M/R/P	XS2C/G
<b>Contacts</b>	<b>Materials</b>	Phosphor bronze	Brass
	<b>Finish</b>	Nickel base, 0.4-μm gold plating	
<b>Thread bracket</b>	<b>Materials</b>	Brass *	
	<b>Finish</b>	Nickel plated *	
<b>Pin block</b>	<b>Materials</b>	PBT resin (UL94V-0)	PBT resin (UL94V-0)
	<b>Finish</b>	For DC: light gray; for AC: dark gray	
<b>O-ring/rubber bushing</b>	Rubber		
<b>Cover</b>	Polyester elastomer	---	PBT resin (UL94V-0)
<b>Cap</b>	---	---	PBT resin (UL94V-0)
<b>Cable clamp</b>	---	---	PA resin (UL94V-0)
<b>Pin clamp</b>	---	---	PBT resin (UL94V-0)
<b>Lock spring</b>	---	---	LCP resin (UL94V-0)
<b>Watertight bushing</b>	---	---	Rubber
<b>Ring</b>	---	---	Steel





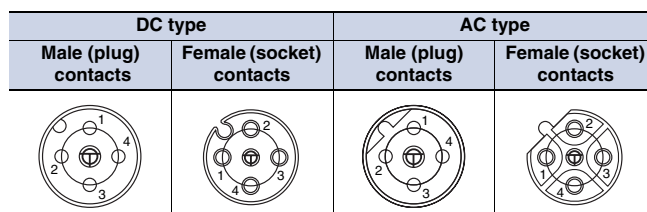





\*The T-joint of the XS2R is aluminum/white.

## Socket Appearance

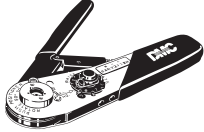

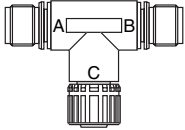
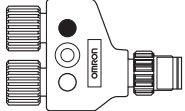
Note: The AC and DC connectors are different as shown here and therefore cannot be connected together.

List of Products

Name	Model		Appearance
<b>1. Connectors attached to Cable</b>	XS2W Sockets and Plugs on Cable Ends		
	XS2F Sockets on One Cable End		
	XS2H Plugs on One Cable End		
<b>2. Connector Assemblies (Crimping, Soldering, or Screw-on)</b>  Used to enable using connectors for sensor cables and relay cables.	XS2G Plug Assemblies		
	XS2C Socket Assemblies		
	XY2F Crimp Tool (for Crimping Connectors)		
	XW4Z Screwdriver (for Screw-on Connectors)		
<b>3. Terminal Box Connectors</b>  Used to enable using connectors for terminal boxes.	XS2P Panel-mounting Sockets		
<b>4. T-Joints and Y-Joints</b>  Used for branching and for daisy-chain connections.	XS2R T-Joint/Y-Joint Plug/Socket Connectors	T-Joints	
		Y-Joints	
<b>5. Sensor Connector Assemblies</b>  Used to enable using connectors in sensors.	XS2M Plugs	Embedded Plugs with Screw Threads	
		Embedded Plugs with No Screw Threads	
<b>6. Panel-mounting Connectors</b>  Used to enable using I/O box connectors mounted to panels.	XS2M Plugs	Flange-mounting Plugs	
		Screw-mounting Plugs	

# XS2W Sockets and Plugs on Cable Ends

## Model Number Legend

Use this model number legend to identify products from their model number. When ordering, use a model number from the table in *Ordering Information*.

**XS2W-D**   **2**   -     **1** -  

1
2
3
4
5
6
7
8
9

### 1. Type

W: Connectors connected to cable, socket and plug on cable ends

### 2. AC/DC (Mating Section Form)

D: For DC

### 3. Connector Poles

4: 4 poles

5: 5 poles

### 4. Contact Plating

2: 0.4-µm gold plating

### 5. Cable Connection Direction

1: Straight/straight

2: L-shaped/L-shaped

3: Straight (XS2F)/L-shaped (XS2H)

4: L-shaped (XS2F)/straight (XS2H)

### 6. Cable Length

A: 0.3 m (straight/straight only)

B: 0.5 m (straight/straight only)

C: 1 m (straight/straight only)

D: 2 m

E: 3 m (straight/straight only)

F: 4 m (straight/straight only)

G: 5 m

H: 7 m (straight/straight only)

J: 10 m (straight/straight only)

K: 15 m (straight/straight only)

L: 20 m (straight/straight only)

### 7. Connections

Pin No.

①

②

③

④

8: Brown White Blue Black (for DC)

Terminal No.

①

②

③

④

⑤

G: Brown White Blue Black Gray

### 8. Connectors on One End/Both Ends

1: Both ends

### 9. Cable Specifications

A: Standard cable

R: Vibration-proof robot cable (straight/straight only)

F: Fire-retardant, vibration-proof cable

# XS2W Sockets and Plugs on Cable Ends

- Connectors with Standard Cable XS2W-D42□-□81-A
- Connectors with Vibration-proof Robot Cable (Straight/Straight) XS2W-D421-□81-R

## Dimensions

(Unit: mm)

### Straight/Straight Connectors

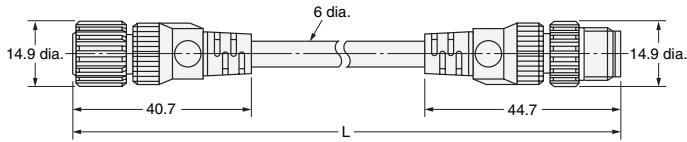

### L-shaped/L-shaped Connectors

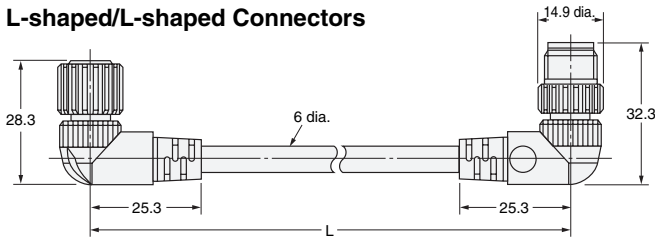

### Straight/L-shaped Connectors

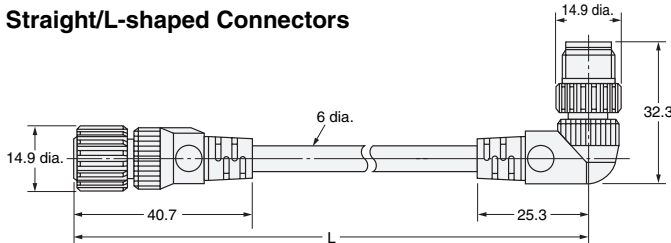

### L-shaped/Straight Connectors

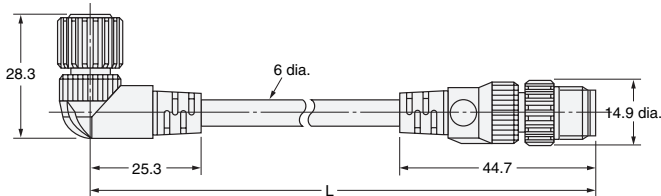

### Wiring Diagram for 4 Cores

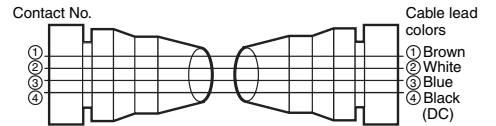

### Wiring Diagram for 5 Cores

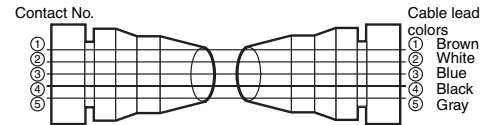

## Ordering Information

Cable type	Cable connection direction	No. of cable cores	Cable core cross-sectional area (mm <sup>2</sup> )	Cable length (m)	DC		UL-listed	
					Model	Minimum order		
Standard cable	Straight/Straight	4	0.5	1	XS2W-D421-C81-A	10	Yes	
				2	XS2W-D421-D81-A			
				5	XS2W-D421-G81-A			
				10	XS2W-D421-J81-A			
	L-shaped/L-shaped			2	XS2W-D422-D81-A	10		
				5	XS2W-D422-G81-A	5		
				Straight/L-shaped	2	XS2W-D423-D81-A		10
					5	XS2W-D423-G81-A		5
L-shaped/Straight	2	XS2W-D424-D81-A	10					
	5	XS2W-D424-G81-A	5					
Vibration-proof robot cable	Straight/Straight	1	XS2W-D421-C81-R	10				
		2	XS2W-D421-D81-R					
		5	XS2W-D421-G81-R					
		10	XS2W-D421-J81-R					

Note: Ask your OMRON representative about other cable lengths, and about 5-core cables.

# XS2F Socket on One Cable End

## Model Number Legend

Use this model number legend to identify products from their model number. When ordering, use a model number from the table in *Ordering Information*.

**XS2F-**  **2**  **0-**    

1
2
3
4
5
6
7
8
9

### 1. Type

F: Connector connected to cable, socket on one cable end

### 2. AC/DC (Mating Section Form)

A: For AC  
 D: For DC  
 E: For DC, stainless steel lock

### 3. Connector Poles

4: 4 poles  
 5: 5 poles

### 4. Contact Plating

2: 0.4-μm gold plating

### 5. Cable Connection Direction

1: Straight  
 2: L-shaped

### 6. Cable Length

A: 0.3 m  
 B: 0.5 m  
 C: 1 m  
 D: 2 m  
 E: 3 m  
 F: 4 m  
 G: 5 m  
 H: 7 m  
 J: 10 m  
 K: 15 m  
 L: 20 m

Only the 2 m (D) and 5 m (G) cables are available for cables with 5 poles.

### 7. Connections

Terminal No.	①	②	③	④
A: Brown	---	---	---	Blue (for DC)
B: ---	---	---	Brown	Blue (for DC)
C: Brown	---	---	Blue	Black
D: ---	---	---	Blue	Brown
8: Brown	White	Blue	Blue	Black (for DC)
9: Brown	White	Blue	Blue	Black (for AC)

### 8. Connectors on One End/Both Ends

0: One end

### 9. Cable Specifications

A: Standard cable  
 R: Vibration-proof robot cable  
 F: Fire-retardant, vibration-proof cable  
 E: Heat-resistant cable up to 105°C  
 R type is a 2- or 4-core cable. F or E type is a 4-core cable.

Designations for DC Polarity (For Limit Switches and Sensors)

### 6. Cable Length

3: 2 m  
 4: 5 m

### 7. Connections

Pin No.	①	②	③	④
1: ---	---	---	Black	White

### 8. Connectors on One End/Both Ends

0: One end

### 9. Cable Specifications

Not designated.

Note: Model number standards are different for items 6, 7, and 9 for non-polar connectors.

Terminal No.	①	②	③	④	⑤
G: Brown	White	Blue	Blue	Black	Gray

# XS2F Sockets on One Cable End

- Connectors with Standard Cable XS2F-□42□-□□0-A
- Connectors with Vibration-proof Robot Cable XS2F-□42□-□□0-R
- Non-polar DC Connectors with Standard Cable XS2F-□42□-□□0

## Dimensions

(Unit: mm)

### Straight Connectors

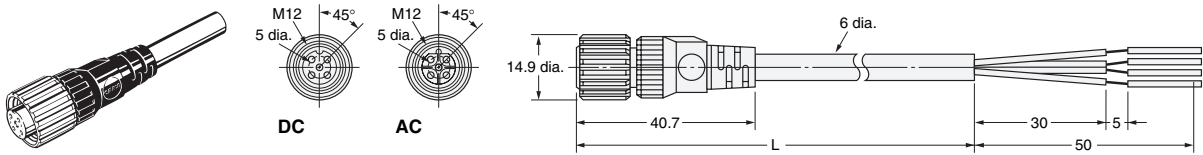

### L-shaped Connectors

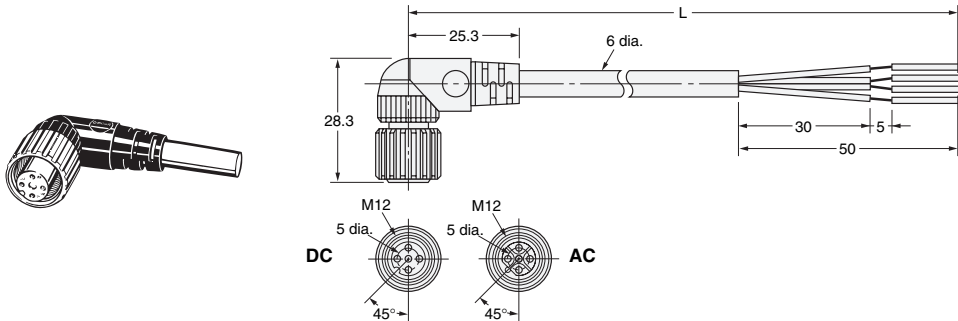

## Wiring Diagram

		Two-core model	Three-core model	Four-core model
Standard cable	XS2F-□42□-□□0-A			
Vibration-proof robot cable	XS2F-□42□-□□0-R			
Standard cable (non-polar DC)	XS2F-□42□-□□0		---	---
Standard cable (E2E models with conventional connector pin)	XS2F-D42□-□D0		---	---

Ordering Information

Cable type	Cable connection direction	No. of cable cores	No. of cable cores	Cable length (m)	DC	AC	Minimum order	UL-listed	
					Model	Model			
Standard cable	Straight	2	0.5	1	XS2F-D421-CA0-A	XS2F-A421-CB0-A	10	Yes	
		3			XS2F-D421-CC0-A	---			
		4			XS2F-D421-C80-A	XS2F-A421-C90-A			
		2		2	XS2F-D421-DA0-A	XS2F-A421-DB0-A			
		3			XS2F-D421-DC0-A	---			
		4			XS2F-D421-D80-A	XS2F-A421-D90-A			
		2		5	XS2F-D421-GA0-A	XS2F-A421-GB0-A			
		3			XS2F-D421-GC0-A	---			
		4			XS2F-D421-G80-A	XS2F-A421-G90-A			
		2		10	XS2F-D421-JA0-A	XS2F-A421-JB0-A			5
	3	XS2F-D421-JC0-A			---				
	4	XS2F-D421-J80-A			XS2F-A421-J90-A				
	2	L-shaped			XS2F-D422-CA0-A	XS2F-A422-CB0-A	10		
	3			XS2F-D422-CC0-A	---				
	4			XS2F-D422-C80-A	---				
	2			2	XS2F-D422-DA0-A	XS2F-A422-DB0-A			
	3				XS2F-D422-DC0-A	---			
	4				XS2F-D422-D80-A	---			
	2			5	XS2F-D422-GA0-A	XS2F-A422-GB0-A			5
	3				XS2F-D422-GC0-A	---			
4	XS2F-D422-G80-A		---						
2	10		XS2F-D422-JA0-A	XS2F-A422-JB0-A	5				
3		XS2F-D422-JC0-A	---						
4		XS2F-D422-J80-A	---						
2		Straight	XS2F-D421-CA0-R	XS2F-A421-CB0-R		10			
4	XS2F-D421-C80-R		XS2F-A421-C90-R						
2	2		XS2F-D421-DA0-R	XS2F-A421-DB0-R					
4			XS2F-D421-D80-R	XS2F-A421-D90-R					
2	5		XS2F-D421-GA0-R	XS2F-A421-GB0-R	5				
4			XS2F-D421-G80-R	XS2F-A421-G90-R					
2	10		XS2F-D421-JA0-R	XS2F-A421-JB0-R	5				
4			XS2F-D421-J80-R	XS2F-A421-J90-R					
2			1	XS2F-D422-CA0-R			XS2F-A422-CB0-R	10	
4				XS2F-D422-C80-R			---		
2	2	XS2F-D422-DA0-R	XS2F-A422-DB0-R	5					
4		XS2F-D422-D80-R	---						
2	5	XS2F-D422-GA0-R	XS2F-A422-GB0-R	5					
4		XS2F-D422-G80-R	---						
2	10	XS2F-D422-JA0-R	XS2F-A422-JB0-R	5					
4		XS2F-D422-J80-R	---						
Standard cable (non-polar)	Straight	2	2	XS2F-D421-310	XS2F-A421-310	10	---		
		2	5	XS2F-D421-410	XS2F-A421-410	5			
	L-shaped	2	2	XS2F-D422-310	XS2F-A422-310	10			
		2	5	XS2F-D422-410	XS2F-A422-410	5			
Standard cable (E2E models with conventional connector pin)	Straight	2	2	XS2F-D421-DD0	---	10	---		
		2	5	XS2F-D421-GD0	---	5			
	L-shaped	2	2	XS2F-D422-DD0	---	10			
		2	5	XS2F-D422-GD0	---	5			
Heat-resistant cable *	Straight	4	2	XS2F-E421-D80-E	---	10	---		
			5	XS2F-E421-G80-E	---	5			
	L-shaped		2	XS2F-E422-D80-E	---	10			
			5	XS2F-E422-G80-E	---	5			

Note: Ask your OMRON representative about other cable lengths.  
 \*The heat-resistant fixture material is SUS316L stainless steel without surface treatment.

Applicable Proximity Sensors

Refer to page the *E2E Datasheet* for information on connecting to E2E Proximity Sensors

● 5-pole Connectors for DC XS2F-D521-□G0-A

Dimensions

(Unit: mm)

Straight Connectors

Note: Use the XS2H-D521-□G0-A in combination with the XS2F-D521-□G0-A.

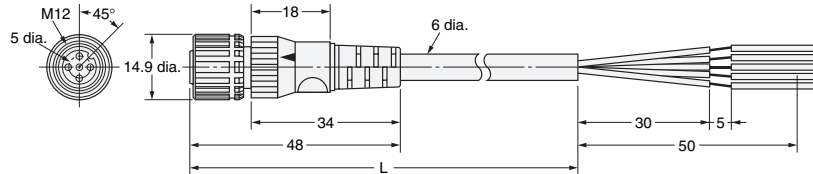
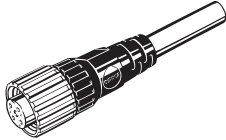

Wiring Diagram

Pin Arrangements (Engagement Side)

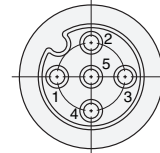
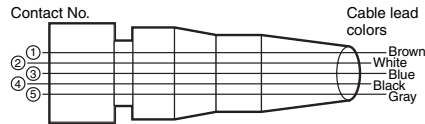

Ordering Information

No. of cable cores	Cable core cross-sectional area (mm <sup>2</sup> )	Cable length (m)	DC	
			Model	Minimum order
5	0.3 mm <sup>2</sup>	2	XS2F-D521-DG0-A	10
		5	XS2F-D521-GG0-A	5

Note: Ask your OMRON representative about other cable lengths.



# XS2H Plugs on One Cable End

## Model Number Legend

XS2H-    21-    0-  

1    2   3 4 5   6 7 8   9

### 1. Type

H: Connector connected to cable, plug on one cable end

### 2. AC/DC

A: For AC  
D: For DC

### 3. Connector Poles

4: 4 poles  
5: 5 poles

Using this model number legend to identify products from their model number. When ordering, use a model number from the table in *Ordering Information*.

### 4. Contact Plating

2: 0.4-μm gold plating

### 5. Cable Connection Direction

1: Straight

### 6. Cable Length

A: 0.3 m  
B: 0.5 m  
C: 1 m  
D: 2 m  
G: 5 m

### 7. Connections

Terminal No.	Terminal No.	Terminal No.
①    ②    ③    ④	①    ②    ③    ④	①    ②    ③    ④    ⑤
8: Brown White Blue Black (for DC)	A: Brown --- --- Blue (for DC)	G: Brown White Blue Black Gray
9: Brown White Blue Black (for AC)	B: --- --- Brown Blue (for AC)	
	C: Brown --- Blue Black (for DC)	

### 8. Connectors on One End/Both Ends

0: One end

### 9. Cable Specifications

A: Standard cable  
F: Fire-retardant, vibration-proof cable  
R: Vibration-proof robot cable  
R type is a 2 or 4-core cable. F type is a 4-core cable.

# XS2H Plugs on One Cable End

● Connectors on Standard Cable XS2H-□421-□□0-A

## Dimensions

(Unit: mm)

### Straight Connectors

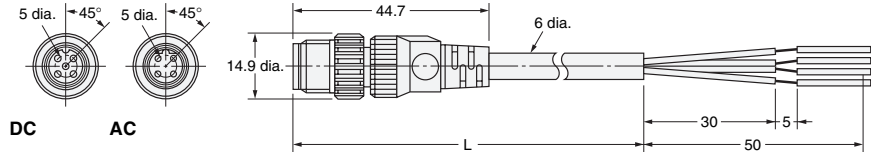
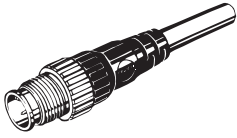

### Wiring Diagram

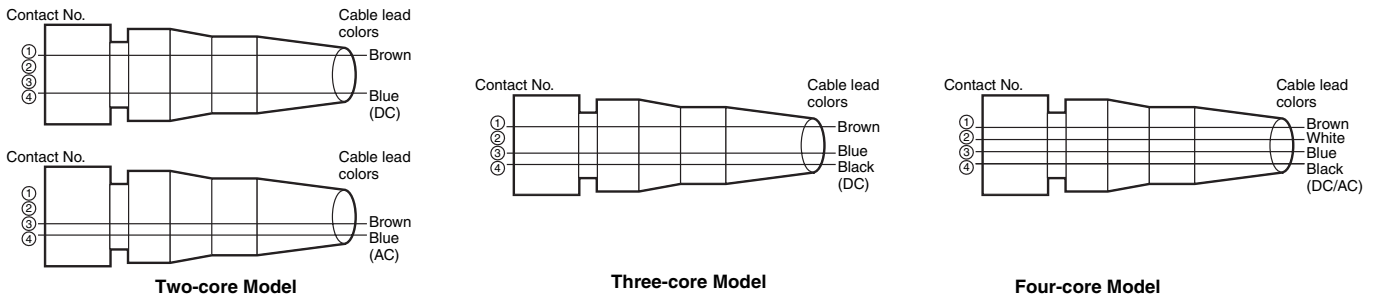

● Connectors on DC Cable (Five Poles) XS2H-D521-□G0-A (for DC)

## Dimensions

(Unit: mm)

### Straight Connectors

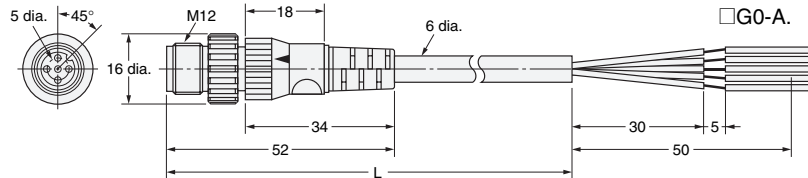
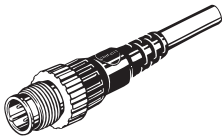

### Wiring diagram

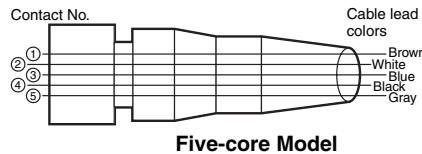

### Pin Arrangements (Engagement Side)

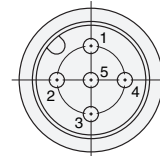

## Ordering Information

No. of connector poles	Cable connection direction	No. of cable cores	Cable core cross-sectional area	Cable length (m)	DC Model	AC Model	Minimum order	UL-listed
4	Straight	2	0.5 mm <sup>2</sup>	0.3	XS2H-D421-AA0-A	XS2H-A421-AB0-A	10	Yes
		3			XS2H-D421-AC0-A	---		
		4			XS2H-D421-A80-A	XS2H-A421-A90-A		
		1		2	XS2H-D421-CA0-A	XS2H-A421-CB0-A		
				3	XS2H-D421-CC0-A	---		
				4	XS2H-D421-C80-A	XS2H-A421-C90-A		
5	Straight	5	0.3 mm <sup>2</sup>	0.3	XS2H-D521-AG0-A	---	---	
				1	XS2H-D521-CG0-A	---		

# XS2 Sensor I/O Connectors on Cables (8-pole)

## Ordering Information

Connector type	Cable connection direction	Number of cores	Cable length (m)	Model
Panel-mounting socket	---	---	---	XS2P-D821-2
Panel-mounting plug				XS2P-D822-2
				XS2M-D824-4
Plug on one cable end	Straight	8	0.3	XS2H-D821-AH0-C
Socket on one cable end			1	XS2H-D821-CH0-C
			2	XS2F-D821-DH0-C
			5	XS2F-D821-GH0-C
Plug and socket on cable ends			2	XS2W-D821-DH1-C
			5	XS2W-D821-GH1-C

## Pin Numbers and Cable Lead Colors

XS2F/XS2H/XS2W cable lead colors	Pin number							
	1	2	3	4	5	6	7	8
	White	Brown	Green	Yellow	Gray	Pink	Blue	Shield

## Ratings and Characteristics

Rated current	1.5 A
Rated voltage	36 VDC
Contact resistance	40 MΩ max. (at 20 mVDC max. and 100 mA max.)
Insulation resistance	1,000 MΩ min. (at 500 VDC)
Dielectric strength	1,000 VAC for 1 min (leakage current: 1 mA max.)
Degree of protection	IP67
Insertion durability	200 times min.
Operating temperature	-25 to 70°C

## Materials and Finish

Contacts	Brass/nickel base, 0.4-μm goldplating
Bracket, body, M16 nuts	Brass/nickel plated
Pin block	PBT resin (UL94V-0)/light gray
Cover *1	Polyester elastomer (UL94V-0)/black
Seal rubber and O-ring *2	Rubber

\*1. XS2F/XS2H/XS2W only.

\*2. O-rings are on sockets only.

## Wiring Example

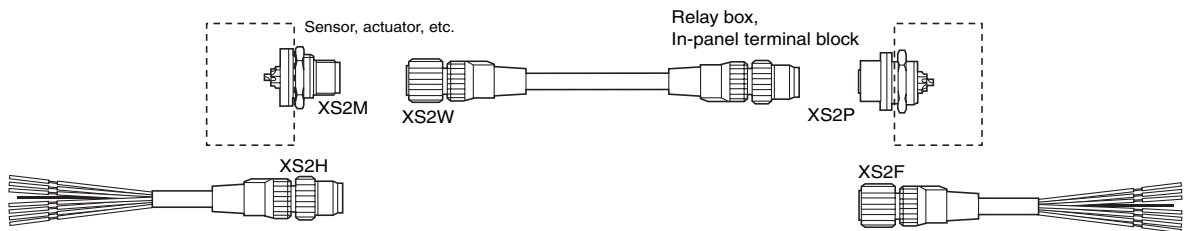

**Dimensions**

**XS2H Plug on One Cable End (M12)**

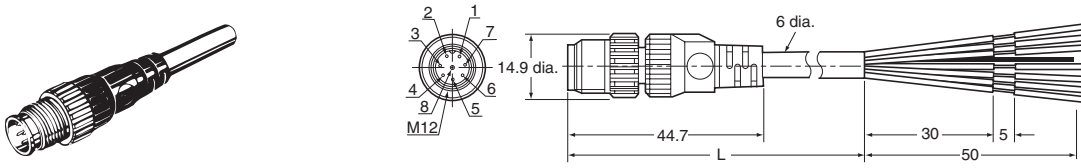

**XS2F Socket on One Cable End (M12)**

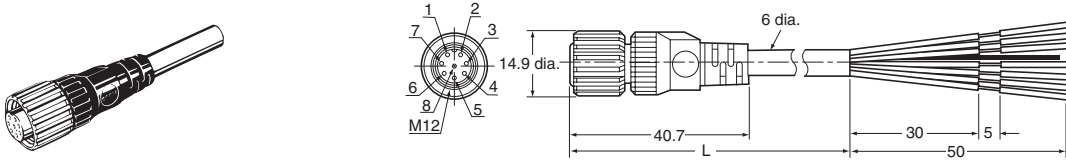

**XS2W Plug and Socket on Cable Ends (M12)**

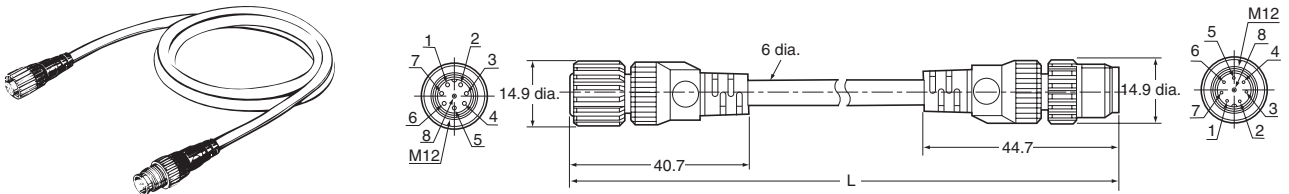

**XS2P-D821-2 Panel-mounting Socket (M12) with Solder Cup Pins and Rear Lock**

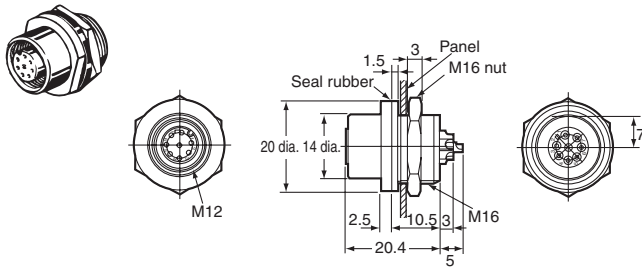

**XS2M-D824-4 Panel-mounting Plug (M12) with Solder Cup Pins and Front Lock**

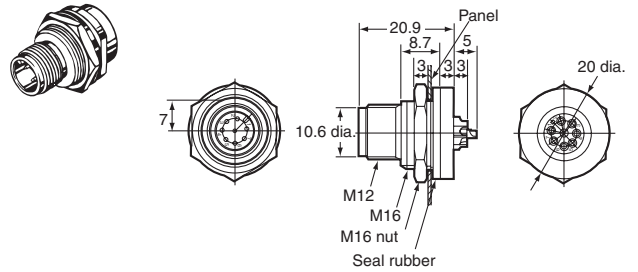

**XS2P-D822-2 Panel-mounting Socket (M12) with Solder Cup Pins and Front Lock**

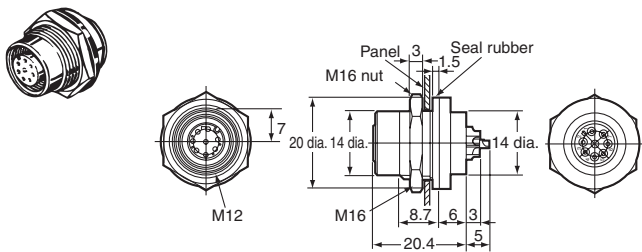

**Panel Cutouts**

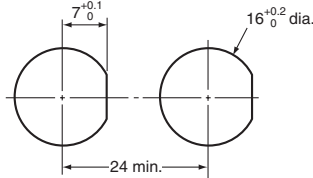

**Connector Pin Numbers (from Mating Side)**

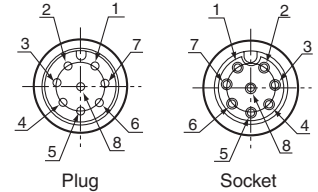

- Note 1. Mounting panel thickness: 1 to 4 mm.
- 2. Applicable core wire size for solder cup pins: 0.5 mm<sup>2</sup> max.
- 3. The M16 nut and seal rubber are included.

# XS2G Crimping/Soldering Plug Assemblies

## Dimensions

(Unit: mm)

XS2G-□4C□ (Crimping Model)  
 XS2G-□42□ (Soldering Model)  
 Straight Connectors

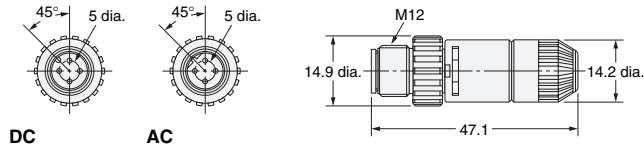
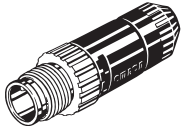

XS2G-D42□ (Soldering Model)  
 L-shaped Connectors

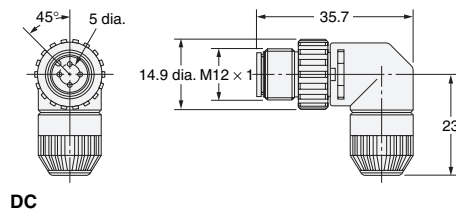
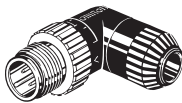

## Ordering Information

Suitable cable dia. (mm)	Cable connection direction	Connection method	DC	AC	Minimum order
			Model	Model	
6-mm-dia. model (5 to 6 mm dia.)	Straight	Crimping	XS2G-D4C1	XS2G-A4C1	50
	L-shaped	Soldering	XS2G-D421	XS2G-A421	
4-mm-dia. model (4 to 5 mm dia.)		Straight	Crimping	XS2G-D4C3	
	L-shaped	Soldering	XS2G-D423	XS2G-A423	
3-mm-dia. model (3 to 4 mm dia.)		Straight	Crimping	XS2G-D4C5	
	L-shaped	Soldering	XS2G-D425	XS2G-A425	
			Soldering	XS2G-D426	

Note: Crimping plug contacts are sold separately.

# XS2U Crimping Pin for XS2G

## Dimensions

(Unit: mm)

XS2U-312□ (Plug Pin)

Note: A special tool must be used for crimping. For details, refer to page 23.

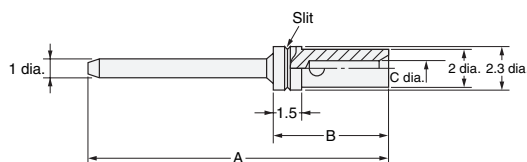

### Dimensions

Model	Suitable core size (mm <sup>2</sup> )	Dimension (mm)			No. of slits
		A	B	C	
XS2U-3121	0.18 to 0.3	20.0	6.1	0.8	1
XS2U-3122	0.5 to 0.75	20.1	6.2	1.3	0

## Ordering Information

Suitable core size (mm <sup>2</sup> )	Model	Minimum order
0.18 to 0.3	XS2U-3121	100
0.5 to 0.75	XS2U-3122	

Note: Orders are accepted in multiples of the minimum order.

# XS2C Crimping/Soldering Socket Assemblies

## Dimensions

(Unit: mm)

XS2C-□4C□ (Crimping Model)  
 XS2C-□42□ (Soldering Model)  
 Straight Connectors

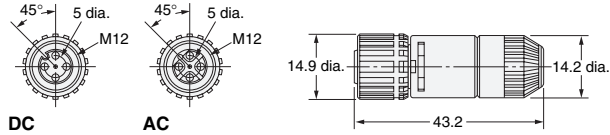
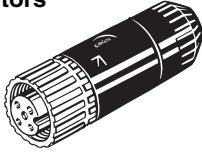

## L-shaped Connectors

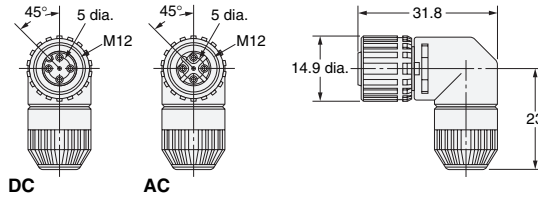

## Ordering Information

Suitable cable dia. (mm)	Cable connection direction	Connection method	DC	AC	Minimum order
			Model	Model	
6-mm-dia. model (5 to 6 mm dia.)	Straight	Crimping	XS2C-D4C1	XS2C-A4C1	50
		Soldering	XS2C-D421	XS2C-A421	
	L-shaped	Crimping	XS2C-D4C2	XS2C-A4C2	
		Soldering	XS2C-D422	XS2C-A422	
4-mm-dia. model (4 to 5 mm dia.)	Straight	Crimping	XS2C-D4C3	XS2C-A4C3	
		Soldering	XS2C-D423	XS2C-A423	
	L-shaped	Crimping	XS2C-D4C4	XS2C-A4C4	
		Soldering	XS2C-D424	XS2C-A424	
3-mm-dia. model (3 to 4 mm dia.)	Straight	Crimping	XS2C-D4C5	XS2C-A4C5	
		Soldering	XS2C-D425	XS2C-A425	
	L-shaped	Crimping	XS2C-D4C6	XS2C-A4C6	
		Soldering	XS2C-D426	XS2C-A426	

Note: Crimping plug contacts are sold separately.

# XS2U Crimping Pin for XS2C

## Dimensions

(Unit: mm)

XS2U-222□ (Socket Pin)

Note: A special tool must be used for crimping. For details, refer to page 23.

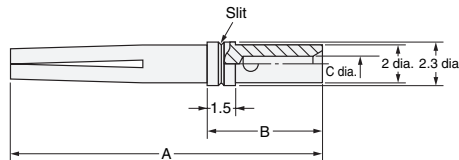
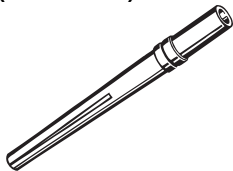

### Dimensions

Model	Suitable core size (mm <sup>2</sup> )	Dimension (mm)			No. of slits
		A	B	C	
XS2U-2221	0.18 to 0.3	16.7	6.1	0.8	1
XS2U-2222	0.5 to 0.75	16.8	6.2	1.3	0

## Ordering Information

Suitable core size (mm <sup>2</sup> )	Model	Minimum order
0.18 to 0.3	XS2U-2221	100
0.5 to 0.75	XS2U-2222	

Note: Orders are accepted in multiples of the minimum order.

# XS2G Screw-on Plug Assemblies

## Dimensions

(Unit: mm)

**XS2G-D5S7 (5-pole, Straight, Applicable Cable Outer Diameter: 8 mm)**

**XS2G-D5S9 (5-pole, Straight, Applicable Cable Outer Diameter: 7 mm)**

**XS2G-D4S7 (4-pole, Straight, Applicable Cable Outer Diameter: 8 mm)**

**XS2G-D4S9 (4-pole, Straight, Applicable Cable Outer Diameter: 7 mm)**

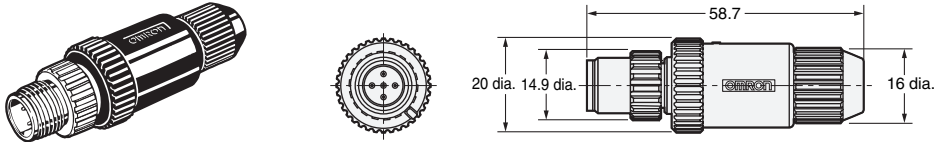

**XS2G-D5S1 (5-pole, Straight, Applicable Cable Outer Diameter: 6 mm)**

**XS2G-D4S□ (4-pole, Straight, Applicable Cable Outer Diameter: 3, 4, or 6 mm)**

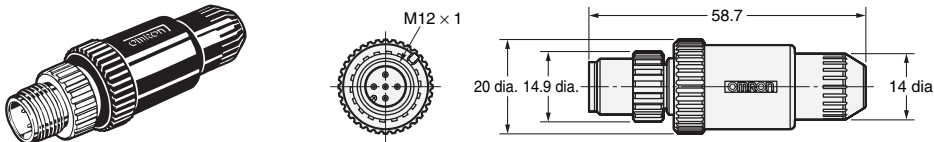

**XS2G-D5S2 (5-pole, L-shaped, Applicable Cable Outer Diameter: 6 mm)**

**XS2G-D4S□ (4-pole, L-shaped, Applicable Cable Outer Diameter: 3, 4, or 6 mm)**

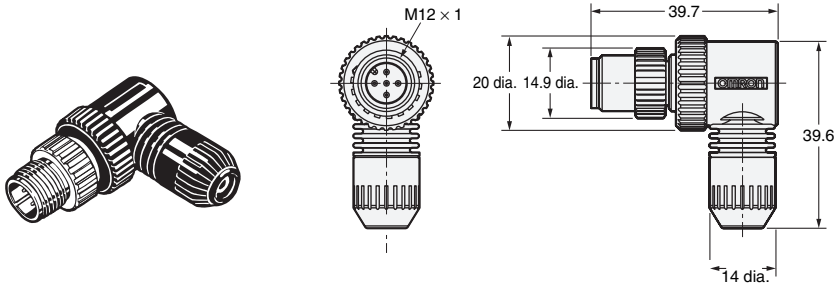

## Ordering Information

No. of poles	Suitable cable dia. (mm)	Straight connectors (for DC)	L-shaped connectors (for DC)	Minimum order
		Model	Model	
5	8-mm-dia. model (7 to 8 mm dia.)	<b>XS2G-D5S7</b>	---	50
	7-mm-dia. model (6 to 7 mm dia.)	<b>XS2G-D5S9</b>	---	
	6-mm-dia. model (5 to 6 mm dia.)	<b>XS2G-D5S1</b>	<b>XS2G-D5S2</b>	
4	8-mm-dia. model (7 to 8 mm dia.)	<b>XS2G-D4S7</b>	---	
	7-mm-dia. model (6 to 7 mm dia.)	<b>XS2G-D4S9</b>	---	
	6-mm-dia. model (5 to 6 mm dia.)	<b>XS2G-D4S1</b>	<b>XS2G-D4S2</b>	
	4-mm-dia. model (4 to 5 mm dia.)	<b>XS2G-D4S3</b>	<b>XS2G-D4S4</b>	
	3-mm-dia. model (3 to 4 mm dia.)	<b>XS2G-D4S5</b>	<b>XS2G-D4S6</b>	

Note: XS2G Screw-on Plugs cannot be connected to side by side to the CN1 and CN2 connectors of XS2R Y-Joint Sockets/Plugs.

# XS2C Screw-on Socket Assemblies

## Dimensions

(Unit: mm)

**XS2C-D5S7 (5-pole, Straight, Applicable Cable Outer Diameter: 8 mm)**

**XS2C-D5S9 (5-pole, Straight, Applicable Cable Outer Diameter: 7 mm)**

**XS2C-D4S7 (4-pole, Straight, Applicable Cable Outer Diameter: 8 mm)**

**XS2C-D4S9 (4-pole, Straight, Applicable Cable Outer Diameter: 7 mm)**

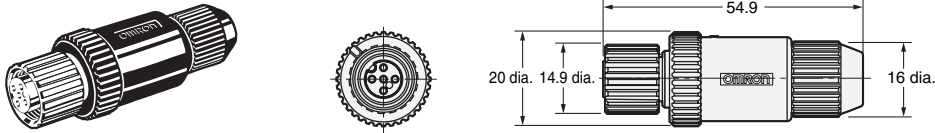

**XS2C-D5S1 (5-pole, Straight, Applicable Cable Outer Diameter: 6 mm)**

**XS2C-D4S□ (4-pole, Straight, Applicable Cable Outer Diameter: 3, 4, or 6 mm)**

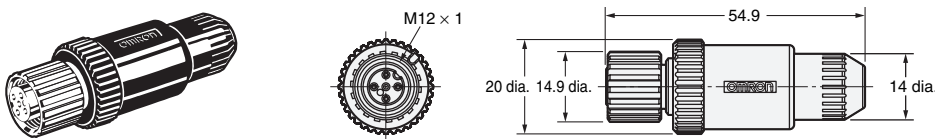

**XS2C-D5S2 (5-pole, L-shaped, Applicable Cable Outer Diameter: 6 mm)**

**XS2C-D4S□ (4-pole, L-shaped, Applicable Cable Outer Diameter: 3, 4, or 6 mm)**

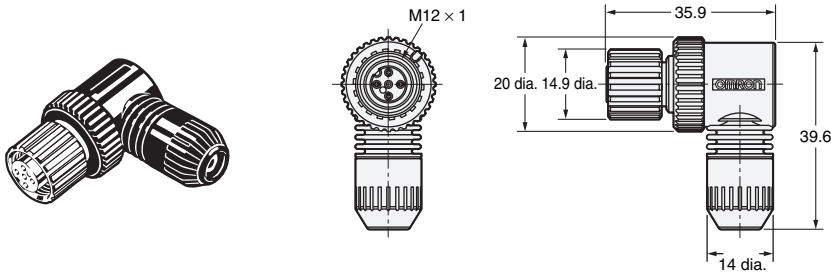

## Ordering Information

No. of poles	Suitable cable dia. (mm)	Straight connectors (for DC)		L-shaped connectors (for DC)		Minimum order
		Model	Model	Model	Model	
5	8-mm-dia. model (7 to 8 mm dia.)	XS2C-D5S7	---	---	---	50
	7-mm-dia. model (6 to 7 mm dia.)	XS2C-D5S9	---	---	---	
	6-mm-dia. model (5 to 6 mm dia.)	XS2C-D5S1	---	XS2C-D5S2	---	
4	8-mm-dia. model (7 to 8 mm dia.)	XS2C-D4S7	---	---	---	
	7-mm-dia. model (6 to 7 mm dia.)	XS2C-D4S9	---	---	---	
	6-mm-dia. model (5 to 6 mm dia.)	XS2C-D4S1	---	XS2C-D4S2	---	
	4-mm-dia. model (4 to 5 mm dia.)	XS2C-D4S3	---	XS2C-D4S4	---	
	3-mm-dia. model (3 to 4 mm dia.)	XS2C-D4S5	---	XS2C-D4S6	---	



# XS2P Panel-mounting Sockets for Terminal Boxes

## Dimensions

(Unit: mm)

### XS2P-□421-2 (with Solder Cup Pins) Rear Lock Model

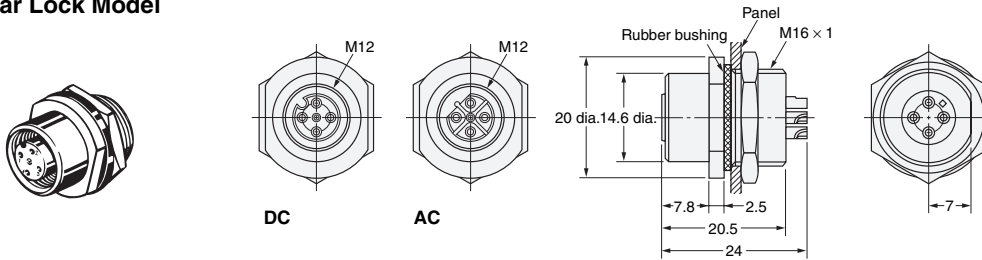

### XS2P-□422-1 (with DIP Pins) XS2P-□422-2 (with Solder Cup Pins) Front Lock Model

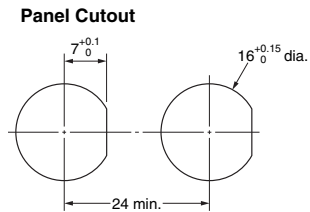
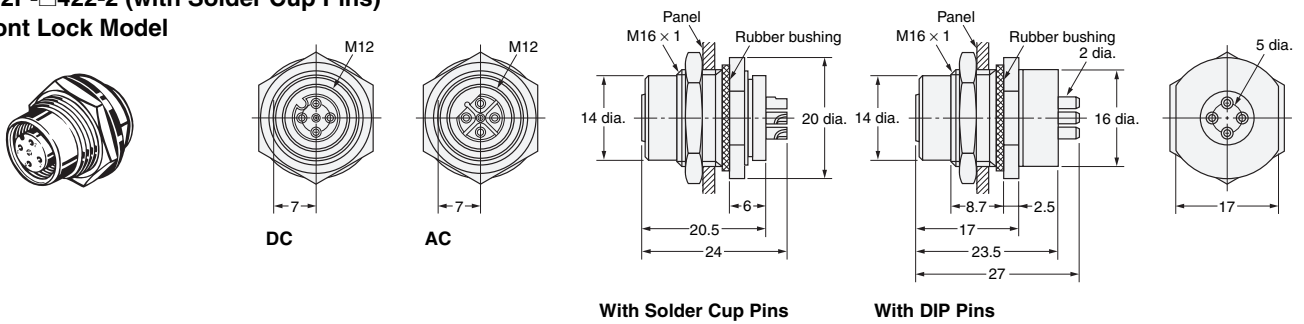

Note: The panel thickness is 1 to 4 mm.

### PCB-mounting Dimensions

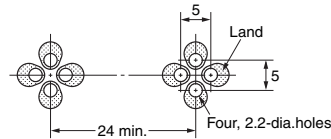

## Ordering Information

Lock method	Pin shape	DC	AC	Minimum order
		Model	Model	
Rear lock	Solder cup pin	XS2P-D421-2	XS2P-A421-2	50
Front lock	Solder cup pin	XS2P-D422-2	XS2P-A422-2	
	DIP pin	XS2P-D422-1	XS2P-A422-1	

# XS2R Y-Joint Plug/Socket Connectors

## Dimensions

(Unit: mm)

### XS2R-D426-□11-F

Connectors on Both Cable Ends (Y-Joint Plug/Socket)

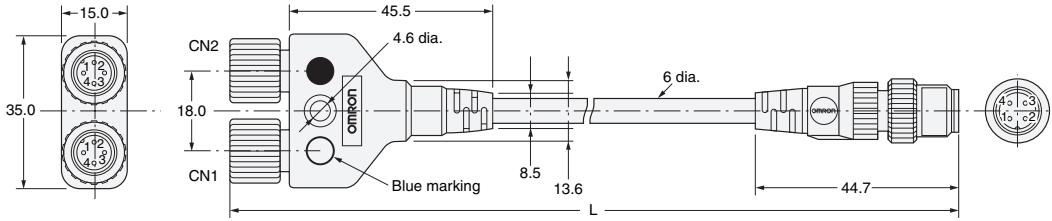

Wiring Diagram

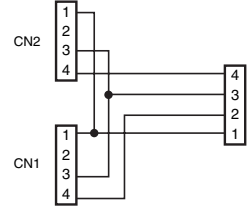

### XS2R-D426-□10-F

Connectors on One Cable End (Y-Joint Plug/Socket)

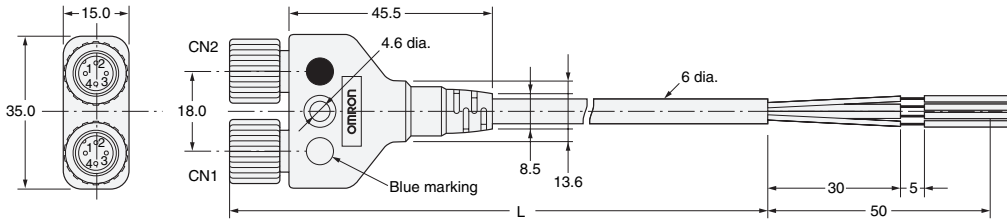

Wiring Diagram

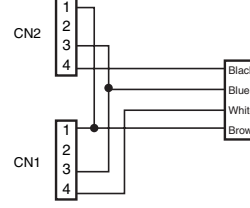

### XS2R-D426-1

Y-Joint Plug/Socket without Cable

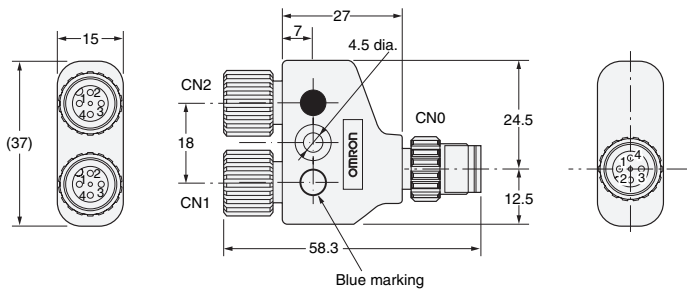

Wiring Diagram

#### XS2R-D426-1

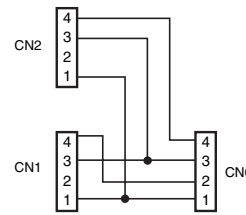

#### XS2R-D426-5

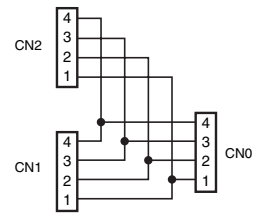

#### XS2R-D426-81

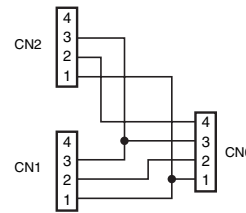

#### XS2R-D426-82

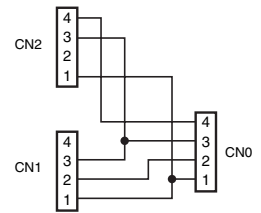

## Ordering Information

Type	Connector	DC		
		Cable length L (m)	Model	Minimum order
With cable	Connectors on both cable ends	0.5	XS2R-D426-B11-F	5
		1	XS2R-D426-C11-F	
		2	XS2R-D426-D11-F	
		3	XS2R-D426-E11-F	
	Connector on one cable end	2	XS2R-D426-D10-F	
		5	XS2R-D426-G10-F	
Without cable	Y-Joint plug/socket	---	XS2R-D426-1	10
		---	XS2R-D426-5	
		---	XS2R-D426-81	
		---	XS2R-D426-82	

Note: XS2G Screw-on Plugs cannot be connected side-by-side to the CN1 and CN2 connectors. Consider using a crimping or soldering model instead. Refer to page 13 for details.

# XS2R T-Joint Plug/Socket Connectors

## Dimensions

(Unit: mm)

XS2R-D422-1  
XS2R-D422-5  
Aggregate Models

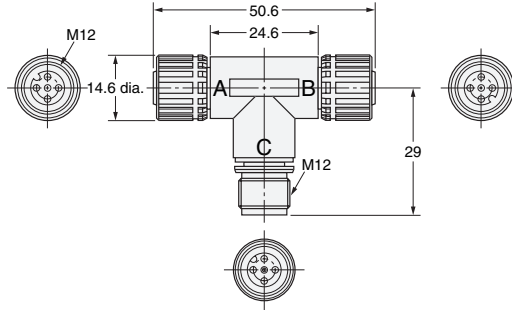
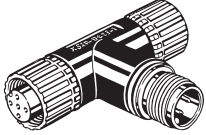

### Wiring Diagram XS2R-D422-1

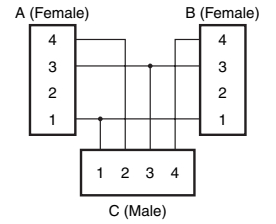

### XS2R-D422-5

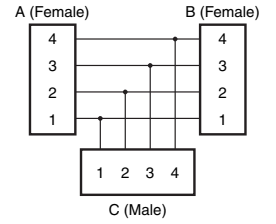

XS2R-D423-1  
Bifurcated Model

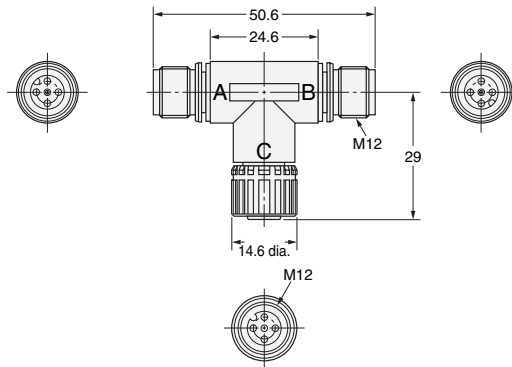
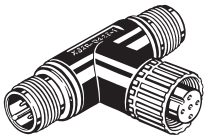

### Wiring Diagram

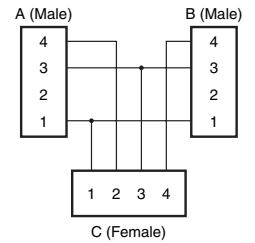

XS2R-D424-1  
Daisy-chain Model

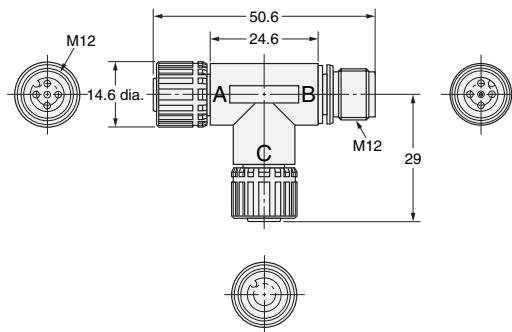
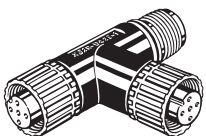

### Wiring Diagram

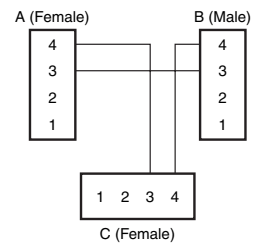

## Ordering Information

Type	DC	
	Model	Minimum order
Aggregate model	XS2R-D422-1	20
	XS2R-D422-5	
Bifurcated model	XS2R-D423-1	
Daisy-chain model	XS2R-D424-1	

## XS2R Application Examples

### XS2R-D422-1 (Aggregate Model)

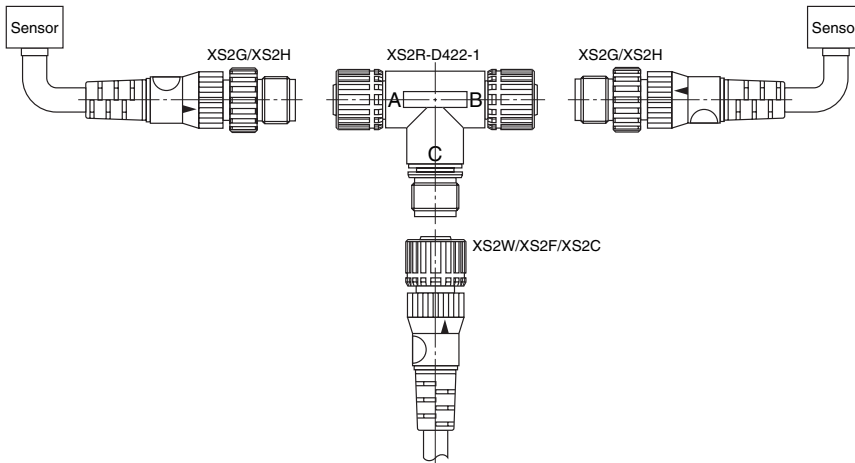

- A pair of Two-wire Sensors or Three-wire Sensors can be connected as shown in the illustration.
- The XS2R-D422-5 has feedthrough connections, thus working as a connector for the extension cable.

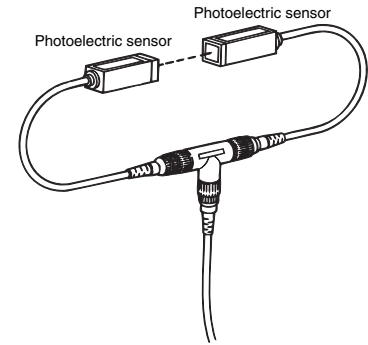

### XS2R-D423-1 (Bifurcated Model)

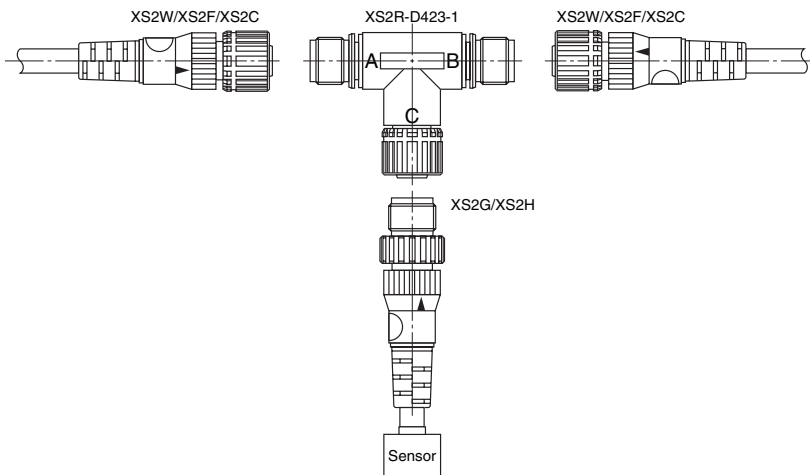

- Two or Three-wire Sensor signals can be bifurcated.

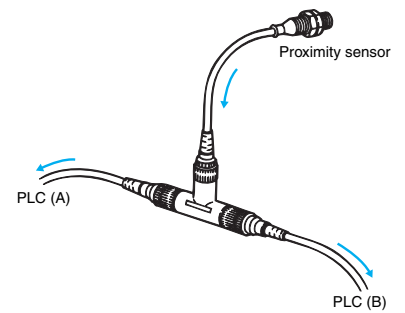

### XS2R-D424-1 (Daisy Chain Model)

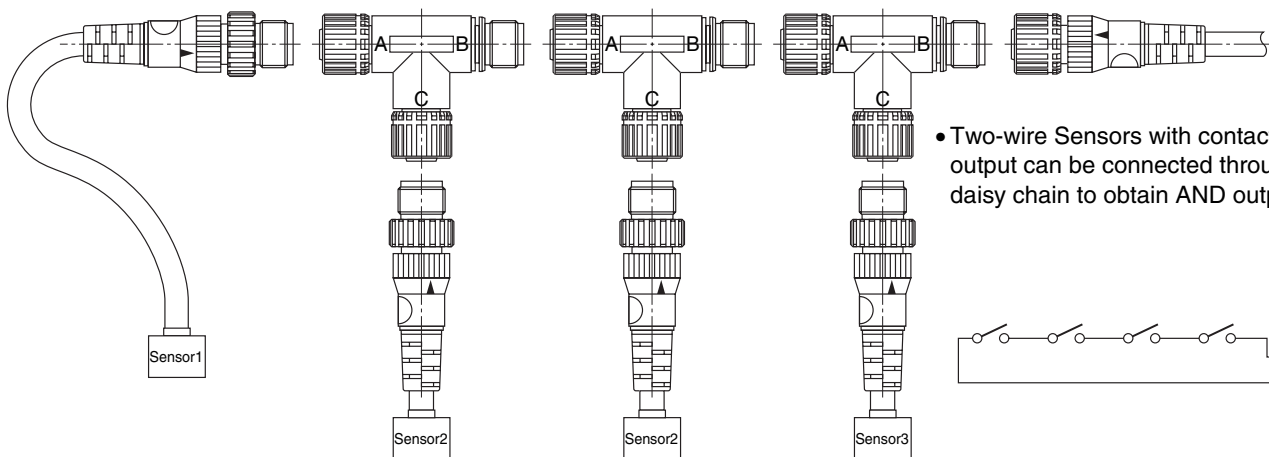

- Two-wire Sensors with contact output can be connected through a daisy chain to obtain AND output.

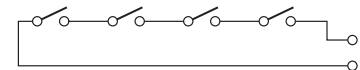

## Safety Precautions

### Precautions for Correct Use

Do not use this product under ambient conditions that exceed the ratings.

Before using the XS2R for Sensors, make sure that the wiring of the Sensors and the internal connections of the XS2R are correct.

# XS2M Sensor-embedded Plugs

## Dimensions

(Unit: mm)

XS2M-D421 (DC)  
XS2M-A421 (AC)  
(Embedded Plug with Screw Threads)

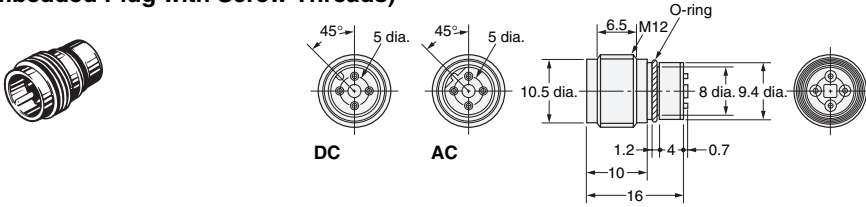

### Mounted Dimensions

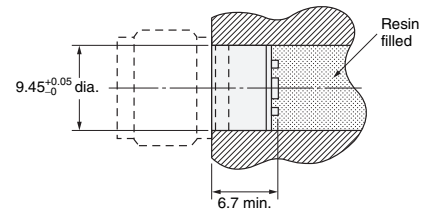

Note: After mounting, anchor the solder cups by injecting resin.

XS2M-D422 (DC)  
XS2M-A422 (AC)  
(Embedded Plug without Screw Threads)

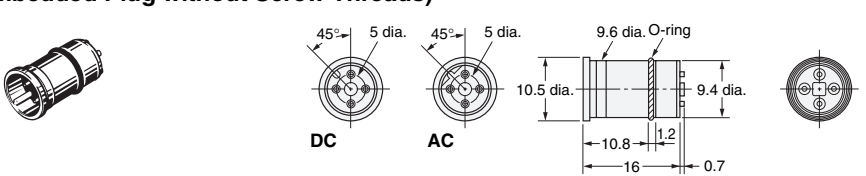

### Mounted Dimensions

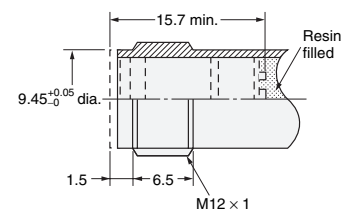

Note: After mounting, anchor the solder cups by injecting resin.

# XS2M Panel-mounting Plugs

## Dimensions

(Unit: mm)

XS2M-D423 (For DC)  
XS2M-A423 (For AC)  
(Flange-mounting Model)

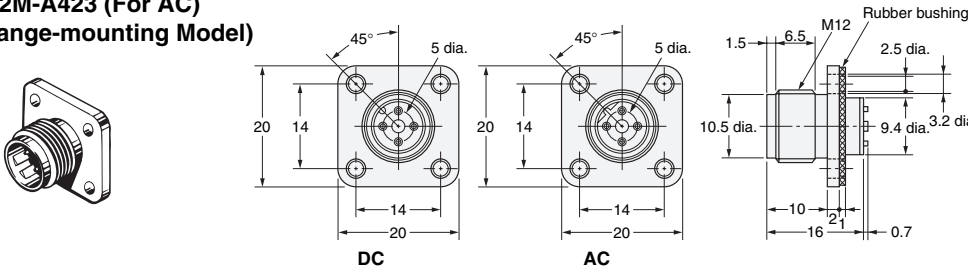

### Panel Cutouts

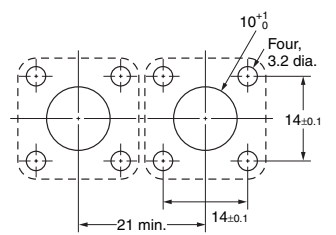

XS2M-□424-1 (With DIP Pins)  
XS2M-□424-2 (With Solder Cup Pins)  
(Screw-mounting Model)

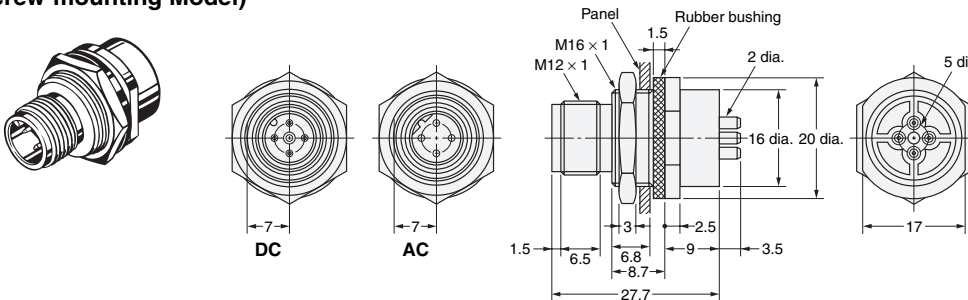

### Panel Cutouts

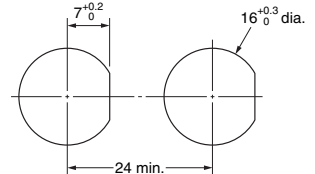

Note: The panel thickness is 1 to 4 mm.

### PCB-mounting Dimensions

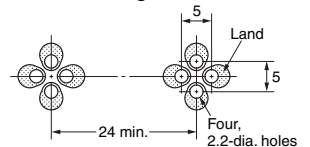

## Ordering Information

Mounting method	Pin shape	DC	AC	Minimum order
		Model	Model	
Embedded with screw threads	Solder cup pin	XS2M-D421	XS2M-A421	50
Embedded with no screw threads		XS2M-D422	XS2M-A422	
Flange-mounting		XS2M-D423	XS2M-A423	
Screw-mounting	DIP pin	XS2M-D424-1	XS2M-A424-1	
	Solder cup pin	XS2M-D424-2	XS2M-A424-2	

## Connector Covers

### Water-resistant Covers

#### XS2Z-11

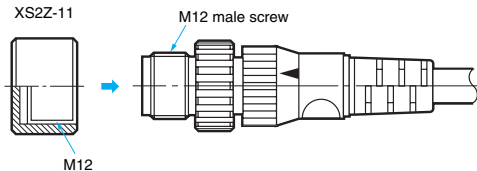

#### XS2Z-22

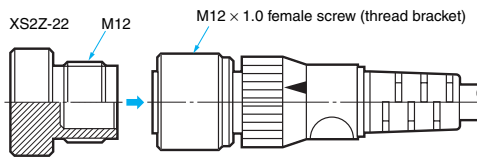

The Water-resistant Cover ensures IP67. When mounting the Water-resistant Cover to a Connector, be sure to apply a torque range between 0.39 and 0.49 N·m to tighten the Water-resistant Cover.

Model	Minimum order	Material	Suitable connector	
			Model	Mounting portion
XS2Z-11	50	Brass/nickel plated	XS2G/XS2H/XS2M/XS2R/XS2W/XS5H/XS5M/XS5W	M12 male screw
XS2Z-22			XS2C/XS2R/XS2F/XS2P/XS2W/XW3B/XS5F/XS5W/XS5R/XS5P/XW3D	M12 female screw (thread bracket)

### Dust Covers

#### XS2Z-13

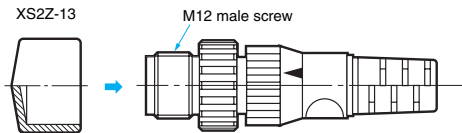

#### XS2Z-15/XS2Z-14

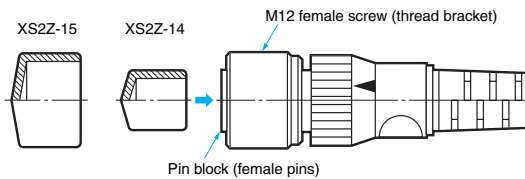

The Dust Cover is for dust prevention and does not ensure IP67 degree of protection. When mounting the Dust Cover to a connector, be sure to press the Dust Cover onto the Connector until the Connector is fully inserted into the Dust Cover.

Model	Minimum order	Material	Suitable connector	
			Model	Mounting portion
XS2Z-13	50	Rubber/black	XS2G/XS2H/XS2M/XS2R	M12 male screw
XS2Z-14			XS2C/XS2R/XS2F/XS2P/XW3A/XW3B	Pin block (female pins)
XS2Z-15				M12 female screw (thread bracket)

### Sputter Protective Cover

#### XS2Z-31

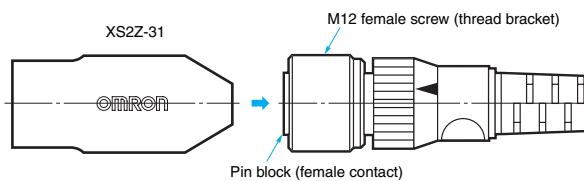
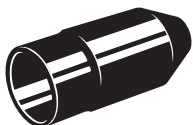

The Sputter Protective Cover protects the connector from weld spatter. Make sure it covers the entire connector.

Model	Material	Applicable connector
XS2Z-31	Silicone rubber/black	XS2F/XS2H/XS2W

**Tools**

**Crimp Tool**

XY2F-0002

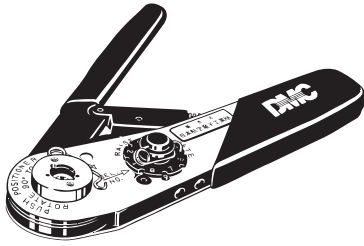

**Locator**

XY2F-0003

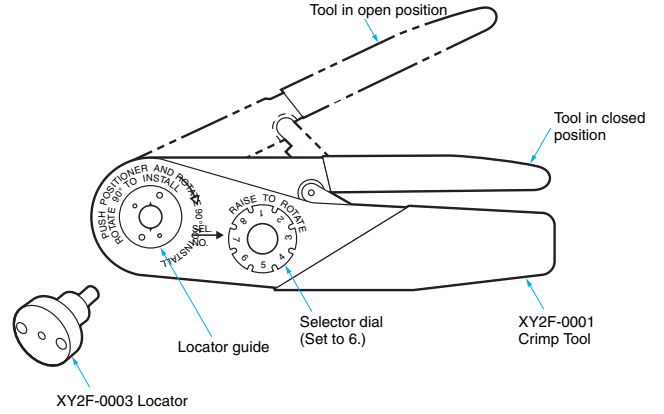

Use the Crimp Tool to crimp a cable core to the XS2U Crimping Pin used with the XS2C or XS2G Crimping Connector.

- The XY2F-0002 Crimp Tool is DMC's AFM8 (M22520/2-01).
- Mount the XY2F-0003 Locator (sold separately) to the locator guide of the Crimp Tool with a screw provided with the XY2F-0003 Locator.

**Pin-block Extraction Tool**

XY2F-0001

Use this tool to extract a Pin Block from the covers in order to make wiring changes or corrections after the cover has been mounted to the pin block for Connector Assemblies (XS2C/ XS2G, soldering/crimping).

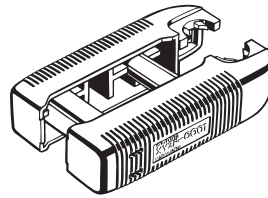

**Extraction Procedure**

(1) Disconnecting Components

- Disconnect all components on the cap side from the cover.

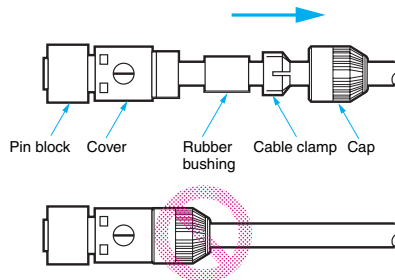

- Make sure that the pin block is outside the Tool.

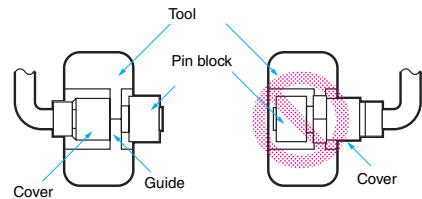

- Press the Tool so that the guides of the Tool are in close contact. Then pull the pin block straight.

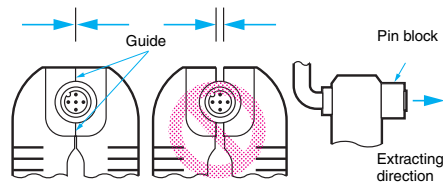

(2) Extracting Pin Block

- Insert the claws of the Tool into the four holes of the cover.

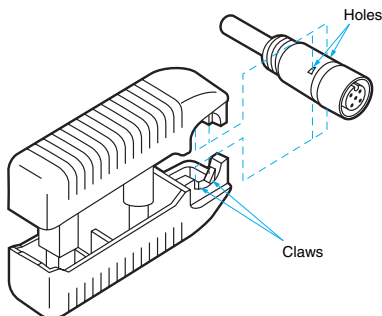

**Precaution**

- The pin block must not be extracted from the same Connector more than 3 times, otherwise the proper degree of protection of the pin block or Connector will not be maintained.

## Assembly Procedure for XS2C/XS2G Connector Assemblies

### (1) Connector and Cable External Diameters

- Connectors for 6-, 4-, and 3-mm-diameter Cables (i.e., Cables that are 5 to 6, 4 to 5, and 3 to 4 mm in diameter respectively) are available. When assembling a Connector used with a cable, make sure that the external diameter of the Connector is suited to that of the cable.
- Connectors for 6-mm-diameter Cables use white cable clamps. Connectors for 4- and 3-mm-diameter Cables use black cable clamps.  
A watertight bushing for 6-mm-diameter Cable has no stripe, that for 4-mm-diameter Cable has a single stripe, and that for 3-mm-diameter Cable has two stripes.

Note: When connecting a commercially available cable to a connector assembly, use a cable with an outside diameter of 3 to 6 mm and core sizes of 0.18 to 0.75 mm<sup>2</sup> for crimping connectors and 0.5 mm<sup>2</sup> maximum for soldering connectors.

### (2) Component Insertion

#### Crimping/Soldering Connectors

##### Straight Connectors

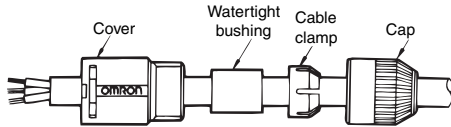

##### L-shaped Connectors

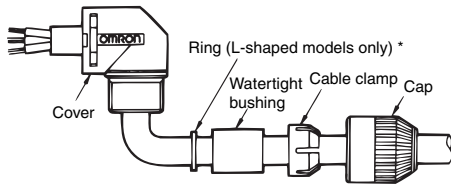

\*A ring is not required for Screw-on Connectors.

- As shown in the above illustration, connect the above components to the Cable with its end processed.

#### Screw-on Connectors

Confirm that you have all of the required parts.

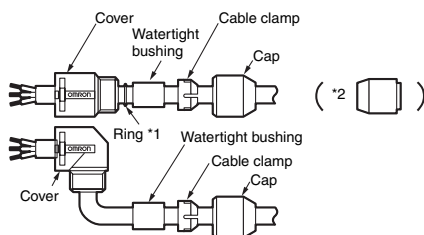

Insulation caps and insulation tubes are included with 5-pole Connectors (XS2C-D5S□ and XS2G-D5S□).

- \*1. Rings are not required with 7-mm and 8-mm cables.
- \*2. Insert the waterproof bushing for 7-mm and 8-mm cables in the direction shown in the diagram.

### (3) Wiring (Processing Cable Ends)

#### Soldering Connectors

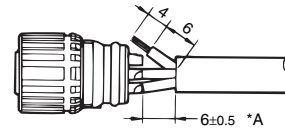

- Strip 10 mm of the Cable sheath and 4 mm of each core.
- Before soldering cores and solder cup pins together, solder-coat each of them.
- The following conditions are recommended for soldering each solder cup pin.  
Soldering iron: 30 to 60 W  
Soldering temperature: 280°C to 340°C  
Soldering period: 3 s max.
- The length marked \*A should be 6.5 mm max., otherwise the proper degree of protection of the connector will not be maintained.

#### Crimping Connectors

##### Crimping

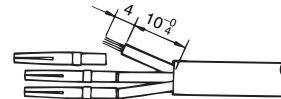

- Strip 14 mm of the Cable sheath and 4 mm of each core.
- Make sure that each core is not damaged and its end strands are not spread out.
- Mount the XY2F-0003 Locator to DMC's AFM8 (M25520/2-01) Crimping Tool, both of which are sold separately, and set the selector dial of the Crimping Tool to 6 for the XS2U-□□21 and to 7 for the XS2U-□□22.
- After mounting the crimping pins to the Locator, fully insert the cores to the crimping pins.
- Squeeze the handle of the Crimp Tool to press-fit the cores to the crimping pins.  
(Squeeze the handle firmly until the handle automatically returns to the release position.)

##### Wiring

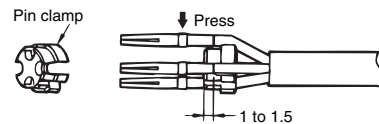

- After press-fitting the cores to the pins, insert the pins into the pin clamp as shown in the illustration. Then make sure that the lead colors correspond to the pin clamp numbers that are identical to the connector pin numbers.



**Insertion**

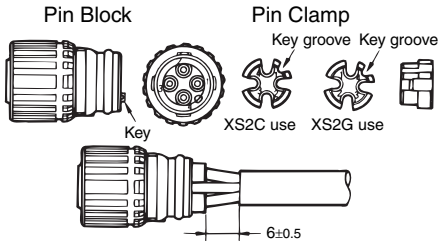

- Tentatively insert the pins to the pin block holes so that the key on the pin block will coincide with the key groove on the pin clamp. Then insert the cable along with the pin clamp.

**Screw-on Connectors**

**Cable End Processing**

**• Four-pole Connectors**

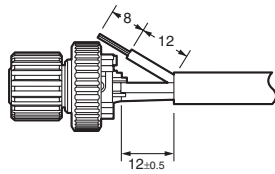

- Loosen the screws on pins 1 to 4 and insert the cores according to the pin numbers.

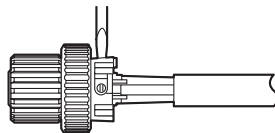

- Use the special Screwdriver (XW4Z-00B) \* and tighten the screws securely so that the cores do not pull out (tightening torque: 0.15 to 0.2 N·m).

**• Five-pole Connectors**

- Strip the cable sheath for a total of 15 mm and strip the core covering for 8 mm for the core to connect to pin 5.

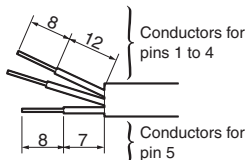

- Connect the core to pin 5 (in the center) first.
- Insert the core from the side of the hold with the tab and tighten the screw securely (tightening torque: 0.15 to 0.2 N·m), and then cut off the excess wire with wire cutters.

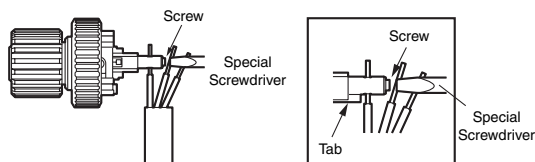

- Bend the cable as shown below, attached the enclosed insulation cap, and then strip the other cores.

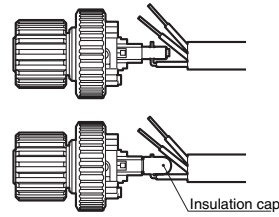

- Connect the cores to pins 1 to 4.

**Connecting Shielded Cables to Five-pole Connectors**

- Place the insulation tub on the drain line of the shield and connect it to the terminal.
- Tighten the screw and then check visually to see if there is insulation between the cores.

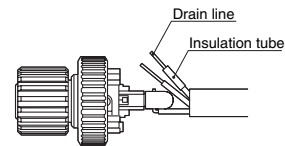

- Connect the cores to pins 1 to 4.

\*When tightening the screws, use the dedicated XW4Z-00B Screwdriver that matches with the screw-slot dimensions.

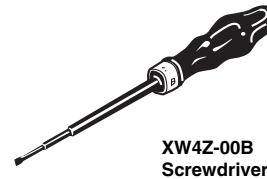

XW4Z-00B Screwdriver

**(4) Inserting Pin Block**

**Pin Block (Soldering Model)      Cover (Straight Model)**

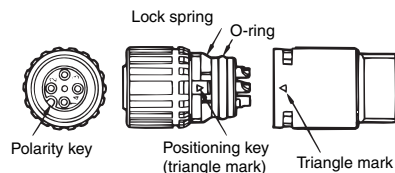

**(Crimping Model)      (L-shaped Model)**

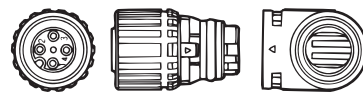

- Mount the cover to the pin block so that the triangle mark on the pin block will coincide with the triangle mark on the cover.
- If the cover is used for an L-shaped model, the relationship between the position of the polarity key on the engaged side and cable connection direction will be determined by the direction in which the positioning key is inserted into the cover, which can be rotated by 90°.
- Fully insert the positioning key until the positioning key is hidden by the casing.

Pin Block  
(Screw-mounting Connectors)      Cover

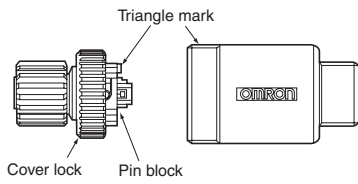

- Align the triangular marks on the pin block and cover and insert the pin block into the cover.
- Press them together firmly (0.39 to 0.49 N·m) until the pin block does not come out of the cover.

**(5) Mounting Cap**

- After mounting the cover to the pin block and the cover snaps into place, tighten the cap securely by hand within a torque of 0.39 and 0.49 N·m.

Note: If the cap is not tighten securely enough, the degree of protection (IP67) may not be maintained or vibration may cause the cap to become loose. Do not tighten the cap with pliers or similar tools; they may damage the cap.

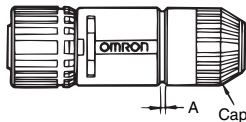

- After fully tightening the cap, length A should be approximately one of the following according to the cable external diameter and the Connector model.

Connector	Cable external diameter (mm)			
	6 mm	5 mm	4 mm	3 mm
For 6-mm-dia. cable	1	0	---	---
For 4-mm-dia. cable	---	2	1	---
For 3-mm-dia. cable	---	---	2	1

**(6) After Assembly**

- Confirm the insulation between cores after completing assembly.

**Recommended Cables**

When connecting a commercially available cable to a connector assembly, use a cable with an outside diameter of 3 to 6 mm and core sizes of 0.18 to 0.75 mm<sup>2</sup> for crimping connectors and 0.5 mm<sup>2</sup> maximum for soldering connectors.

**Connector Arrangement**

For safety, when constructing a connection system between a Sensor and panel with a connector, make sure that the connector plug is on the Sensor side and the connector socket is on the panel side (i.e., the female pins are located on the power-supply side).

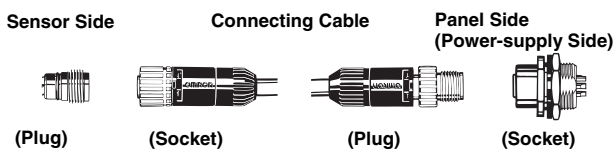

**Safety Precautions**

**Precautions for Correct Use**

Do not use the product in atmospheres or environments that exceed product ratings.

**Tightening Cap (Connector Assemblies)**

1. Do not use pliers to tighten caps, otherwise the caps may be damaged. Be sure to tighten each cap by hand within a torque range between 0.39 and 0.49 N·m.
2. If caps are not tightened securely, the Connectors may not maintain their proper degree of protection (i.e., IP67) or the caps may become loose due to vibration.

**Connector Connection and Disconnection**

- When connecting or disconnecting Connectors, be sure to hold the Connectors by hand.
- Do not hold the cable part when disconnecting Connectors.
- Connectors mating with sockets must be fully inserted into the sockets. Tighten the thread bracket carefully so that the threads will not be damaged.
- Fully tighten thread bracket within a torque range between 0.39 and 0.49 N·m and be sure that the threads of the opposite parts are hidden by the thread bracket.
- When disconnecting Connectors, be sure to loosen the thread brackets first. Do not loosen the caps.
- Thread brackets must be loosened in the cutout direction.

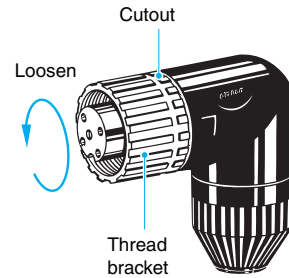

**Degree of Protection**

- Do not impose external force continuously on the joints of pin blocks and covers, otherwise the Connectors may not keep its proper degree of protection (i.e., IP67).
- The degree of protection of connectors (IP67) is not for a fully watertight structure. Do not use them underwater.
- Connectors are of resin mold construction. Do not impose excessive force on them.

**Setup**

- Do not make any cable bends near the base of the Unit.
- Any bends made must have a minimum radius of 40 mm.