

# BNC SERIES RF CO-AXIAL CONNECTORS

## Overview

The BNC series are most widely used as 50Ω coaxial connectors, and compact size, light weight, and quick mounting and dismounting (bayonet lock coupling). Suitable for coaxial cables (RG-55.58/U) with a finished outside diameter of  $\phi 3\text{-}\phi 8$ .

## Applicable standards

Defense Agency (NDS XC 6103, DSP C 6202)

Japanese Industrial Standards (JIS C 5412)

NTT (Model 2095 3C connector)

\*Meets MIL Specifications. (See Products Meeting MIL Specifications Index Table, pages 220-221.)

## Electrical Specifications

Item	Standard
Characteristic impedance	50Ω(*1)
Withstand voltage	1,500Vr.m.s. for 1min.
Insulation resistance	5,000MΩ or more at 500VDC
Contact resistance	3mΩ or less at 1ADC
Applicable frequency range	DC-4GHz
Voltage standing wave	1.2 or less(DC-2GHz)

(\*1) Not different in electrical specifications from the 50Ω cable when connected to the 75Ω coaxial cable (3C-2V) for use at low frequencies (DC-200MHz).

## Main Materials/Finish

Part	Material	Finish (*2)
Armor (shell)	Brass	Silver-plated, Nickel-plated
Male terminal	Brass	Silver-plated, Gold-plated
Female terminal	Beryllium copper	Silver-plated, Gold-plated
Beryllium copper	Tetraflouride resin	—
Gasket	Silicon rubber	—

(\*2) Surface treatment differs according to the product number unit.  
For details, see the BNC Connector List.

# BNC SERIES RF CO-AXIAL CONNECTORS

Plug

Applicable cable	Part No.	HRS No.	Dimension			Shape
			$\phi D$	$\phi d$	L	
RG-55/U, 58/U	UG-88/U	302-0001-0	5.4	11.1	26.5	Fig.1
	UG-88D/U	302-0070-3	5.6	12.7	28.8	Fig.1
	3CA-P2	302-0203-5	5.6	13.7	29.5	Fig.1
RG-59/U, 62/U	UG-260/U	302-0002-3	6.6	11.1	26.0	Fig.1
RG-188A/U	BNC-P-188A/U	302-0216-7	3.0	8.0	25.0	Fig.4
RG-196A/U	BNC-P-196/U	302-0214-1	2.3	5.0	27.3	Fig.6
5D-2W,	BNC-P-5DW-1	302-0189-6	8.5	14.0	35.0	Fig.3
5D-2W, 5C-2W	BNC-P-5DW-SA	302-0217-0	8.7	15.0	33.7	Fig.2
5D-2V	BNC-P-5DV	302-0132-9	7.8	15.0	31.0	Fig.1
5D-2V, 5C-2V	BNC-P-5DV-SA	302-0218-2	8.0	15.0	33.7	Fig.2
3C-2Z	3CZ-P	302-0215-4	6.5	13.7	29.5	Fig.1
3C-2T	3CT-P	302-0210-0	8.0	14.2	29.7	Fig.1
	3CT-P-1	302-0208-9	8.4	14.0	30.0	Fig.3
	3CT-P3	302-0270-2	8.4	14.0	30.0	Fig.3
3D-XW (Irrax cable)	3DW-P2	302-0129-4	6.0	13.7	29.5	Fig.1
3C-2W	3DW-P	302-0209-1	7.1	14.2	29.7	Fig.1
3D-2V, 3C-2V	BNC-P-3DV-SA	302-0219-5	6.3	15.0	33.7	Fig.2
3C-2V	3CV-P2	302-0202-2	6.3	13.7	29.5	Fig.1
	BNC-P-3	302-0030-9	6.4	11.1	26.5	Fig.1
	3CV-P3	302-0269-3	6.8	14.0	30.0	Fig.3
1.5D-2W, 1.5C-2W	BNC-P-1.5WCR	302-0295-3	1.8	10.0	28.1	Fig.5
1.5D-2W	BNC-P-1.5W	302-0299-4	3.9	8.0	25.0	Fig.4
1.5D-2V, 1.5C-2V	BNC-P-1.5CR	302-0294-0	1.8	10.0	28.1	Fig.5
1.5D-2V	BNC-P-1.5	302-0257-4	3.5	8.0	25.0	Fig.4

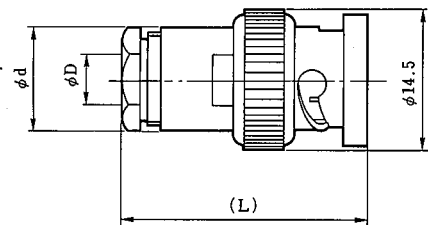

Fig. 1

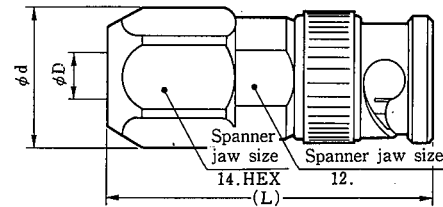

Fig. 2

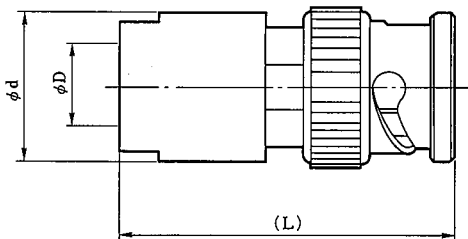

Fig. 3

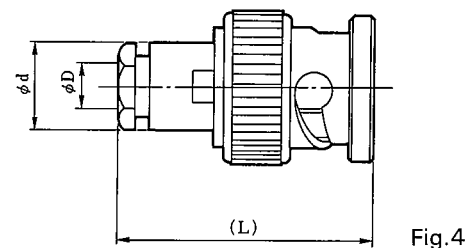

Fig. 4

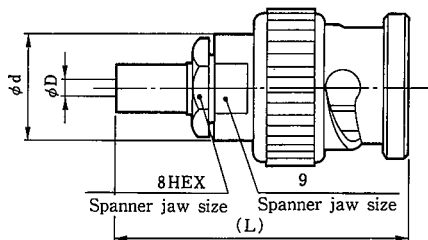

Fig. 5

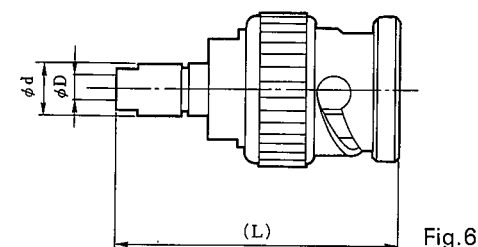

Fig. 6

# BNC SERIES RF CO-AXIAL CONNECTORS

## L-shaped Plug

Applicable cable	Part No.	HRS No.	Dimension				Shape
			$\phi D$	$\phi d$	W1	W2	
BG-55/U, 58/U	UG-913/U(02)	302-0043-0-02	5.4	12.7	11.1	11.1	Fig.7
RG-59/U, 62/U	BNC-LP-59/U	302-0075-7	6.6	12.7	11.1	11.1	Fig.7
3D-XW	3DW-PL2	302-0166-0	6.0	13.7	12.0	12.0	Fig.8
3C-2W	3CW-PL	302-0158-2	7.1	14.2	13.0	13.0	Fig.8
3C-2V	3CV-PL	302-0157-0	6.3	13.7	12.0	12.0	Fig.8

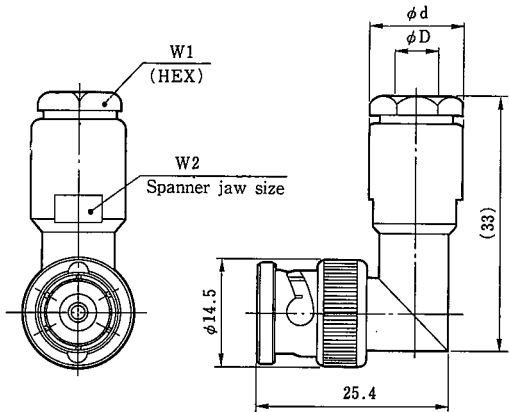

Fig.7

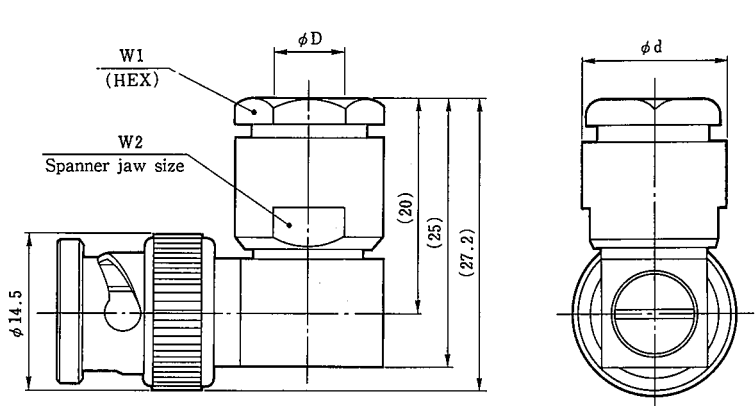

Fig.8

## Jack

Applicable cable	Part No.	HRS No.	Dimension					Shape
			$\phi D$	$\phi d$	W1	W2	L	
RG-55/U, 58/U	UG-89/U	302-0034-0	5.4	11.1	9.5	12.7	28.7	Fig.9
RG-59/U, 62/U	UG-261/U	302-0035-2	6.6	11.1	9.5	12.7	30.0	Fig.9
3C-2V	3CV-J	302-0006-4	6.3	11.1	9.5	11.5	28.7	Fig.9
1.5D-2W, 1.5C-2W	BNC-J-1.5WCR	302-0297-9	1.8	—	8.0	13.0	31.0	Fig.10
1.5D-2V, 1.5C-2V	BNC-J-1.5CR	302-0296-6	1.8	—	8.0	13.0	31.0	Fig.10

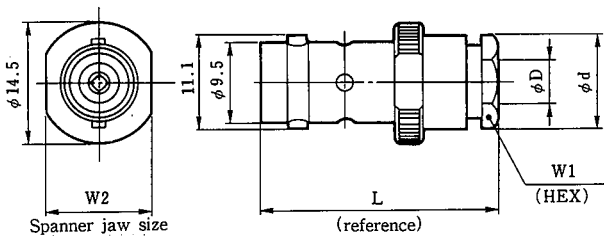

Fig.9

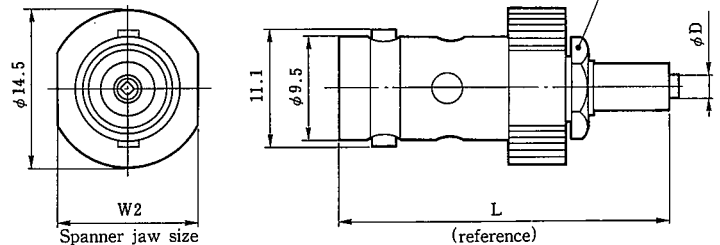

Fig.10

# BNC SERIES RF CO-AXIAL CONNECTORS

## Panel Jack

Applicable cable	Part No.	HRS No.	Dimensions								Shape	Mounting hole dimensions
			$\phi D$	$\phi d$	L	$\ell$	$\square P$	$\square S$	G	W		
RG-55/U, 58/U	UG-291/U	302-0036-5	5.4	11.1	28.2	18.1	12.7	17.5	$M2.6 \times 0.45$	9.5	Fig.11	1-1
	3CA-PJ2	302-0205-0	5.4	11.1	28.7	18.1	12.7	17.5	$\phi 3$	9.5	Fig.11	1-2
RG-59/U, 62U	UG-262/U	302-0007-7	6.6	11.1	28.4	18.1	12.7	17.5	$M2.6 \times 0.45$	9.5	Fig.11	1-1
RG-188A/U	BNC-PJ-188/U	302-0230-8	3.0	9.0	26.8	18.1	12.7	17.5	$M2.6 \times 0.45$	7.0	Fig.11	1-3
RG-196A/U	BNC-PJ-196/U	302-0194-6	2.3	5.0	28.0	18.1	12.7	17.5	$M2.6 \times 0.45$	4.0	Fig.11	1-4
3D-XW (Irrax cable)	BNC-PJ-3DW	302-0236-4	6.0	12.0	30.4	18.1	12.7	17.5	$\phi 3$	12.0	Fig.11	1-5
3C-2W	3CW-PJ	302-0139-8	7.2	14.0	31.4	18.1	12.7	17.5	$\phi 3$	13.0	Fig.11	1-6
3C-2V	3CV-PJ2	302-0204-8	6.3	11.1	28.7	18.1	12.7	17.5	$\phi 3$	9.5	Fig.11	1-2
2.5D-2V	BNC-PJ-1.5DV	302-0238-0	4.7	11.1	28.7	18.1	12.7	17.5	$\phi 3$	9.5	Fig.11	1-2
1.5D-2W	BNC-PJ-1.5	302-0228-6	4.5	9.5	26.8	18.1	12.7	17.5	$M2.6 \times 0.45$	7.0	Fig.11	1-7
	BNC-PJ-1.5W-1	302-0260-9	4.5	9.5	26.8	20.1	12.7	17.5	$\phi 2.9$	7.0	Fig.11	1-8
	BNC-PJ-1.5W-2	302-0282-1	4.5	9.5	26.8	20.1	12.7	17.5	$M2.6 \times 0.45 \phi 3$	7.0	Fig.11	1-9
1.5D-2V	BNC-PJ-1.5DV-1	302-0285-0	3.4	9.5	26.8	18.1	12.7	17.5	$\phi 3$	7.0	Fig.11	1-8

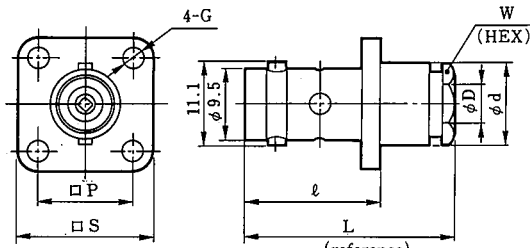

Fig. 11 (reference)

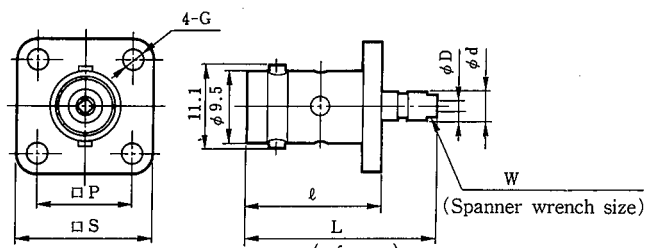

Fig. 12 (reference)

Applicable cable	Part No.	HRS No.	Dimension						Shape	Mounting hole dimensions
			$\phi D$	$\phi d$	L	$\ell$	W1	W2		
RG-55/U, 58/U	BNC-PJ-58	302-0108-4	5.4	1/2-28NEF-2A	28.5	16.9	9.5	17.0	Fig.13	4-1
1.5D-2W	BNC-BPJ-1.5W	302-0284-7	4.5	3/8-32NEF-2A	26.8	12.8	7.0	11.0	Fig.15	3-3
	BNC-BPJ-1.5W-1	302-0289-0	4.5	3/8-32NEF-2A	26.8	15.2	7.0	12.7	Fig.14	2-1
1.5D-2V	BNC-BPJ-1.5-1	302-0252-0	3.5	3/8-32NEF-2A	26.8	15.2	7.0	12.7	Fig.14	2-1

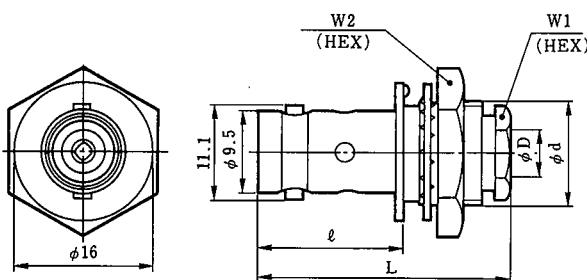

Fig. 13

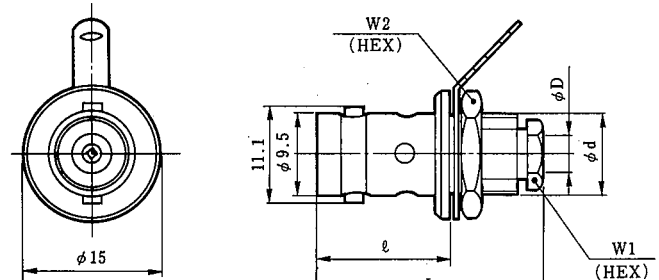

Fig. 14

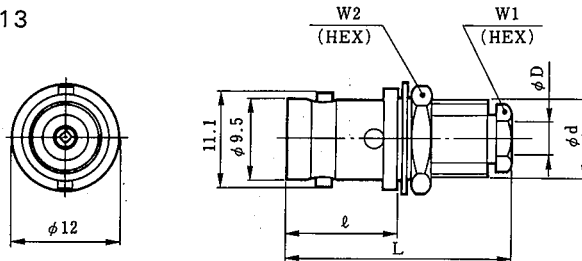

Fig. 15

# BNC SERIES RF CO-AXIAL CONNECTORS

## L-shaped Jack

Applicable cable	Part No.	HRS No.	Dimension							Mounting hole dimensions
			$\phi D$	$\phi d$	L	$\ell 1$	$\ell 2$	W1	W2	
1.5D-2V	BNC-LPJ-1.5	302-0255-9	3.5	3/8-32NEF-2A	33.3	21.7	14.0	7.0	12.7	2-1

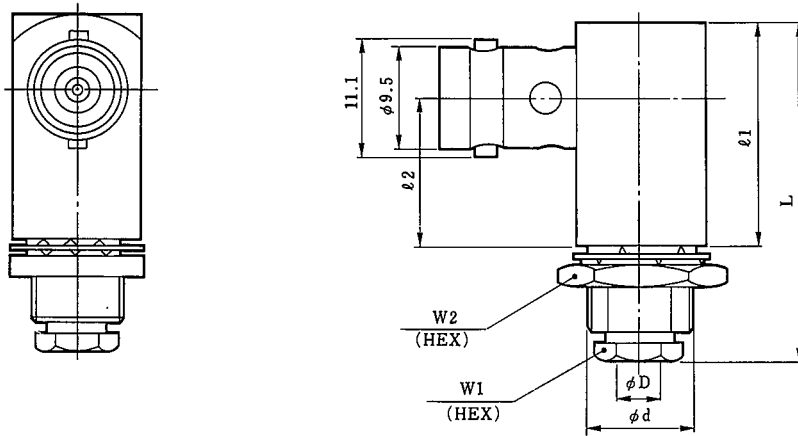
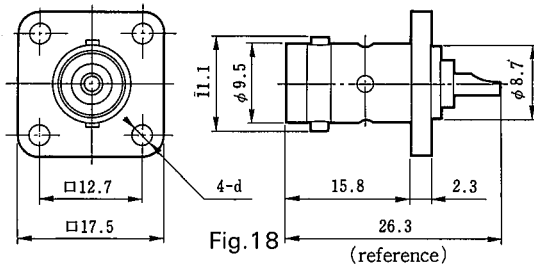

Fig.16

# BNC SERIES RF CO-AXIAL CONNECTORS

## Receptacles

Part No.	HRS No.	d	Mounting hole dimensions
UG-290/U	302-0009-2	M2.6×0.45	1-10
3C-R	302-0031-1	φ3	1-11



Part No.	HRS No.	L	ℓ <sub>1</sub>	ℓ <sub>2</sub>	Remarks	Mounting hole dimensions
BNC-R-12	302-0229-9	19.6	0	1.5	Tab terminal	1-12
BNC-R-13	302-0239-2	21.6	2.0	1.5	Tab terminal	1-12

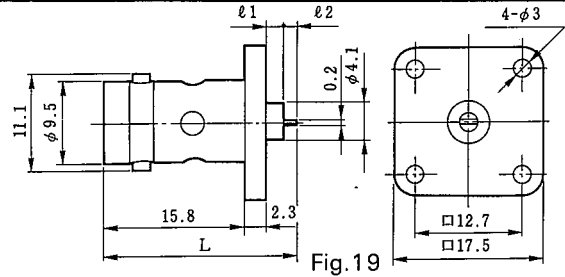

Part No.	HRS No.	Remarks	Mounting hole dimensions
BNC-R-14	302-0245-5	Round half cut terminal	1-12

Part No.	HRS No.	Remarks	Mounting hole dimensions
BNC-LR	302-0020-5		1-11

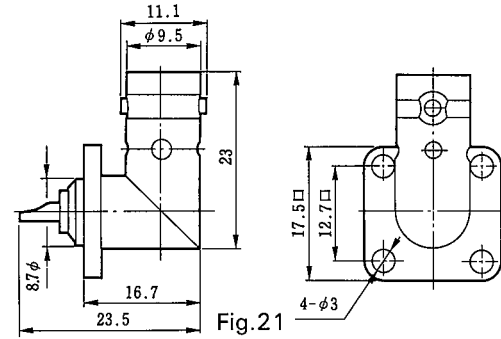
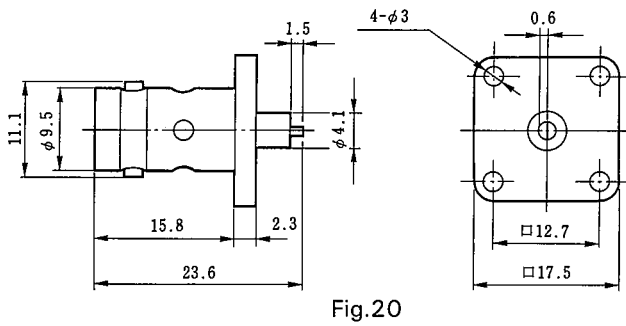

Part No.	HRS No.	φD	L	ℓ	W	Panel-mount type	Shape	Mounting hole dimensions
UG-604/U	302-0016-8	14.5	26.3	13.7	12.7	2.8	Fig.25	3-1
UG-625/U	302-0017-0	12.7	26.3	12.7	12.7	4	Fig.25	2-3
UG-625/U-4	302-0221-7	12.7	26.3	12.7	12.7	4	Fig.23	2-3
UG-625/U-10	302-0253-3	12.7	21.9	12.7	—	1.3	Fig.24	3-2
UG-625/U-11A	302-0274-3	12.7	24.2	12.7	12.7	4	Fig.25	2-4
UG-657/U	302-0012-7	14.5	32.6	15.2	12.7	5.6	Fig.25	3-3
UG-657/U-E	302-0080-7	14.5	32.6	15.2	12.7	5.6	Fig.23	3-3
UG-1094/U	302-0178-0	12.7	27.0	11.9	12.7	4	Fig.25	2-4

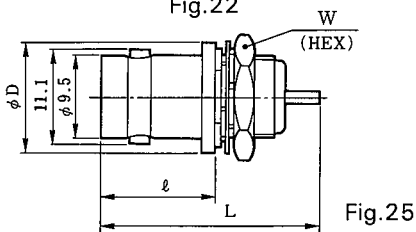
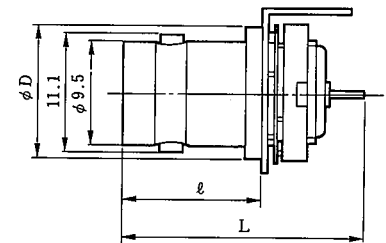
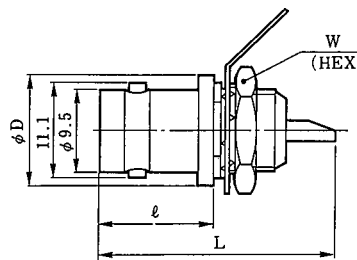
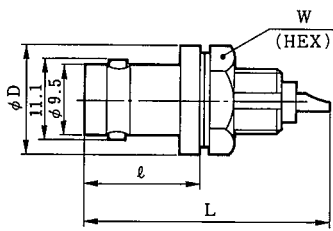

# BNC SERIES RF CO-AXIAL CONNECTORS

Part No.	HRS No.	Shape	Mounting hole dimensions
BNC-R-17A	302-0278-4	Fig.26	3-1

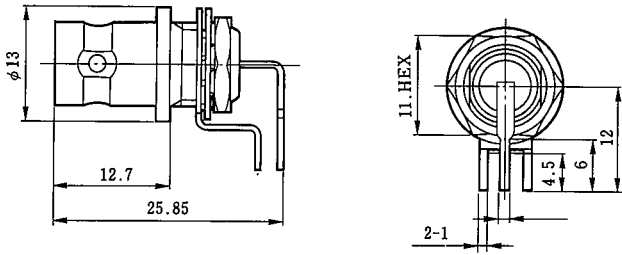
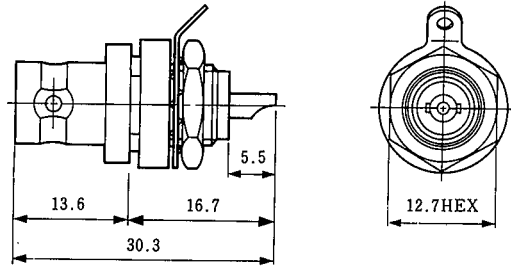

Fig.26

Part No.	HRS No.	Shape	Mounting hole dimensions
BNC-FBR(01)	302-0268-0-01	Fig.27	2-3
BNC-FBR-DF1	302-0287-5	Fig.28	2-3
BNC-FBR-W	302-0279-7	Fig.29	—



Outside-insulating connector Fig.27

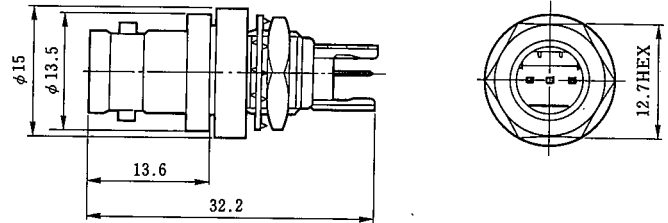

Fig.28

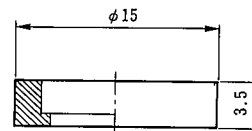

Fig.29

Washer mounted on BNC-FBR(01), shown in Fig.28, to connect the panel to the connector external conductor.

## Plug receptacles

Part No.	HRS No.	Mounting hole dimensions
BNC-BPR-3	302-0249-6	2-1

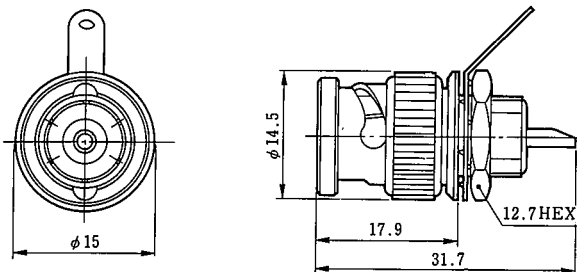

Fig.30

# BNC SERIES RF CO-AXIAL CONNECTORS

## Printed-circuit-board mounting type

Part No.	HRS No.	Shape	L	ℓ 1	ℓ 2	Mounting hole dimensions
BNC-R-PC	302-0241-4	Fig.31	23.1	18.1	5.0	6-1
BNC-R-PC-2	302-0243-0	Fig.32	20.4	17.1	3.3	7-2
BNC-R-PC-7	302-0280-6	Fig.31	23.1	20.64	2.46	6-1

Part No.	HRS No.	Shape	Mounting hole dimensions
BNC-LR-PC	302-0242-7	Fig.33	6-1
BNC-LR-PC-1	302-0262-4	Fig.34	7-1
BNC-LR-PC-3	302-0276-9	Fig.35	6-1

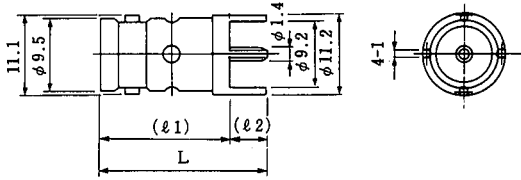

Fig.31

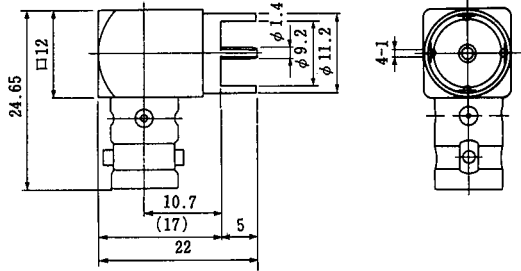

Fig.33

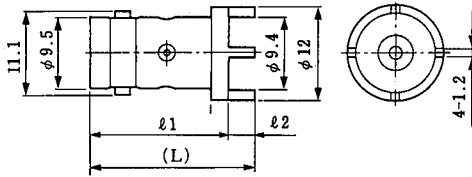

Fig.32

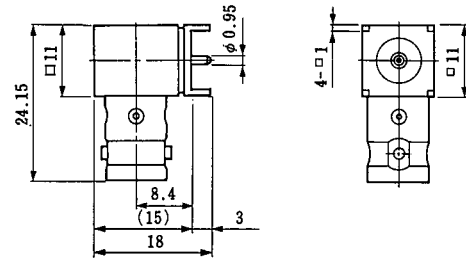

Fig.34

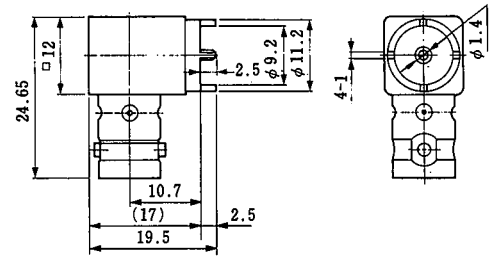

Fig.35

## Lug terminal

Part No.	HRS No.	Remrks
BNC-EL	302-0079-8	Earth Lug

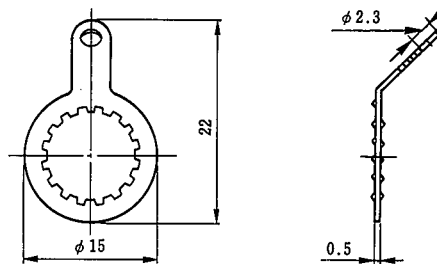

Fig.36

# BNC SERIES RF CO-AXIAL CONNECTORS

## Adapters

Part No.	HRS No.	Shape
BNC-A-JJ	302-0039-3	Fig.37
BNC-A-JJ-1	302-0050-6	Fig.38

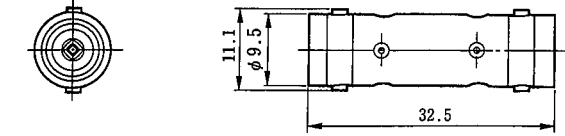

Fig.37

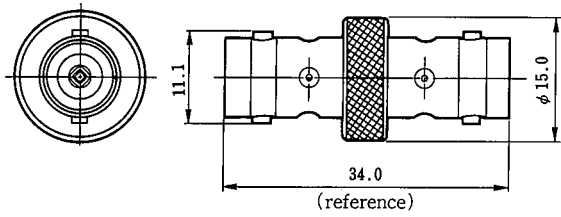

Fig.38

Part No.	HRS No.	L	ℓ	d	Shape
BNC-PA-JJ	302-0052-1	34	15.85	φ3	Fig.39
UG-414/U	302-0040-2	32.54	17.6	M2.6×0.45	Fig.39

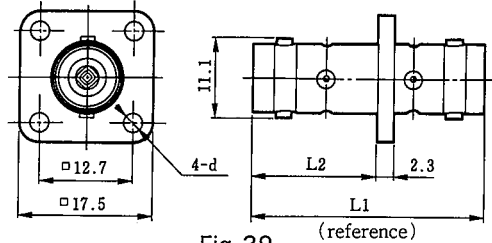

Fig.39 (reference)

Part No.	HRS No.	Remarks
UG-491/U	302-0022-0	A-PP

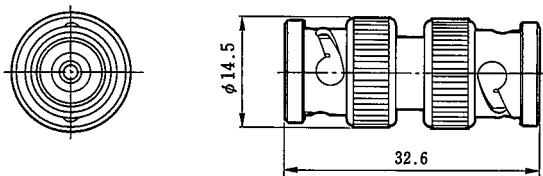

Fig.40

Part No.	HRS No.	Remarks
UG-492/U	302-0021-8	Hermetic type

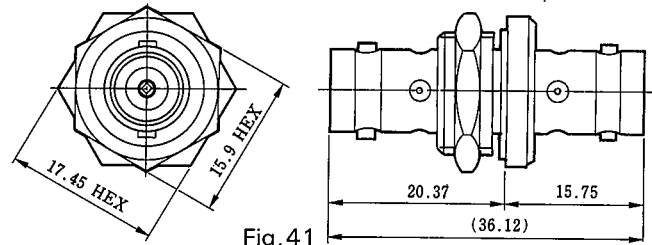

Fig.41

Panel thickness: 4mm  
 Mounting dimensional drawing: See the attached drawing 5.  
 Mounting hole: φ12.9+0.1/0

Part No.	HRS No.	Remarks
UG-306/U	302-0023-3	LA-PJ

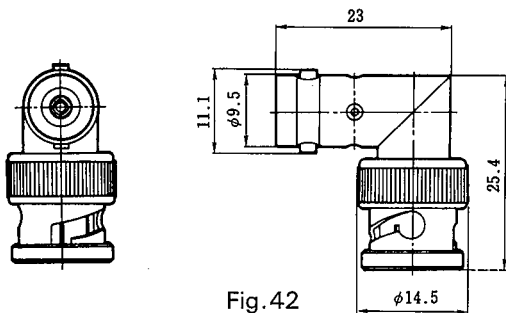

Fig.42

Part No.	HRS No.	Remarks
BNC-TA-JJJ	302-0024-6	

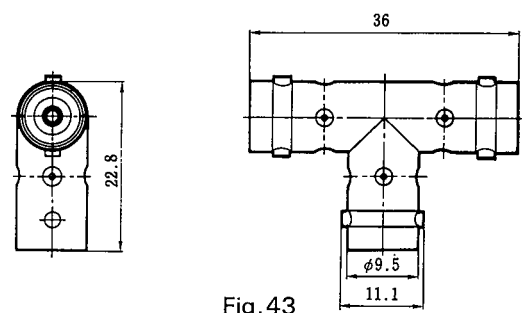

Fig.43

Part No.	HRS No.	Remarks
UG-274/U	302-0025-9	TA-JPJ

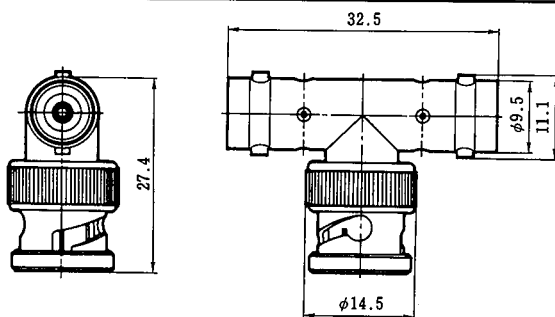

Fig.44

Part No.	HRS No.	L	Remarks
BNC-UPA	302-0167-3	35	U Link

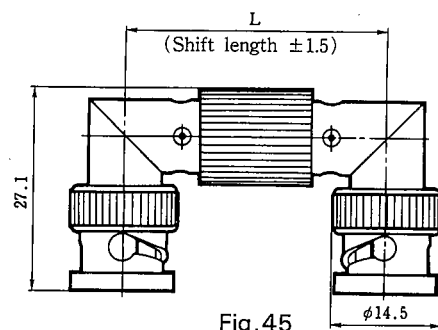

Fig.45

# BNC SERIES RF CO-AXIAL CONNECTORS

## Cap

## Short plug

Part No.	HRS No.	Remarks
CW-123A/U	302-0041-5	—

Part No.	HRS No.	Remarks
JCW-159/U	302-0026-1	Short Plug

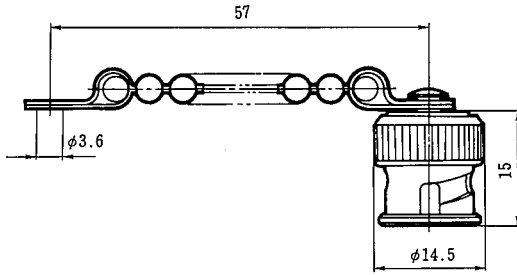

Fig.46

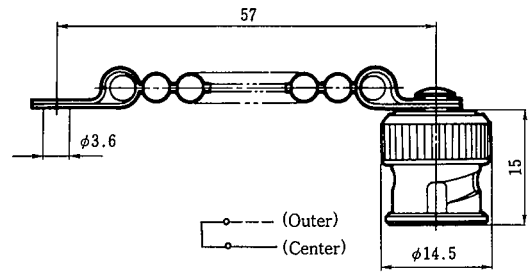

Fig.47

# BNC SERIES RF CO-AXIAL CONNECTORS

## Model BNC Connector List

Type	Part No.	HRS No.	Applicable cable	Surface treatment				Remarks
				Armor		Center contact		
				Silver	Nickel	Silver	Gold	
Straight plug	UG-88/U	302-0001-0	RG-55/U, 58/U	○		○		
	UG-88/U(06)	302-0001-0-06			○	○		
	UG-88/U(10)	302-0001-0-10		○		○		CO2SPM2.9
	UG-88D/U	302-0070-3		○		○		
	3CA-P2	302-0203-5		○		○		
	3CA-P2(02)	302-0203-5-02			○	○		
	UG-260/U	302-0002-3	RG-59/U, 62/U	○		○		
	UG-260/U(10)	302-0002-3-10		○		○		CO2SPM3.7
	BNC-P-188A/U	302-0216-7	RG-188A/U	○		○		
	BNC-P-196/U	302-0214-1	RG-196A/U	○			○	
	BNC-P-5DV	302-0132-9	5D-2V	○		○		
	BNC-P-5DV-SA	302-0218-2	5D-2V, 5C-2V	○		○		
	BNC-P-5DV-SA(10)	302-0218-2-10			○	○		
	BNC-P-5DW-1	302-0189-6	5D-2W	○		○		
	BNC-P-5DW-SA	302-0217-0	5D-2W, 5C-2W	○		○		
	3DW-P2	302-0129-4	3D-XW (Irrex cable)	○		○		
	BNC-P-3	302-0030-9	3C-2V	○		○		
	BNC-P-3(02)	302-0030-9-02				○	○	
	BNC-P-3DV-SA	302-0219-5	3D-2V, 3C-2V	○		○		
	BNC-P-3DV-SA(01)	302-0219-5-01				○	○	
	3CV-P2	302-0202-2	3C-2V	○		○		
	3CV-P2(03)	302-0202-2-03				○	○	
	3CV-P2(06)	302-0202-2-06				○		○
	3CV-P3	302-0269-3			○		○	
	BNC-P-1.5WCR	302-0295-3	1.5D-2W,1.5C-2W		○	○		
	BNC-P-1.5	302-0257-4	1.5D-2V		○	○		
	BNC-P-1.5CR	302-0294-0	1.5D-2V,1.5C-2V		○	○		
	3CZ-P	302-0215-4	3C-2Z	○		○		
	3CT-P	302-0210-0	3C-2T	○		○		
	3CT-P-1	302-0208-9			○		○	
3CT-P3	302-0270-2			○		○		
3CW-P	302-0209-1	3C-2W		○		○		

# BNC SERIES RF CO-AXIAL CONNECTORS

Type	Part No.	HRS No.	Applicable cable	Surface treatment				Remarks
				Armor		Center contact		
				Silver	Nickel	Silver	Gold	
L-shaped plug	UG-913/U(02)	302-0043-0-02	RG-55/U, 58/U	○		○		
	BNC-LP-59/U	302-0075-7	RG-59/U, 62/U	○		○		
	3DW-PL2	302-0166-0	3D-XW(lrrex cable)	○		○		
	3CV-PL	302-0157-0	3C-2V	○		○		
	3CV-PL(02)	302-0157-0-02			○		○	
	3CW-PL	302-0158-2	3C-2W	○		○		
Jack	UG-89/U	302-0034-0	RG-55/U, 58/U	○		○		
	UG-89/U(03)	302-0034-0-03			○	○		
	UG-261/U	302-0035-2	RG-59/U, 62/U	○		○		
	3CV-J	302-0006-4	3C-2V, (3D-2V)	○		○		
	BNC-J-1.5WCR	302-0297-9	1.5D-2W, 1.5C-2W		○	○		
	BNC-J-1.5CR	302-0296-6	1.5D-2V, 1.5C-2V		○	○		
Panel jack	UG-291/U	302-0036-5	RG-55/U, 58/U	○		○		
	UG-291/U(06)	302-0036-5-06				○	○	
	UG-291/U(10)	302-0036-5-10			○		○	CO2CRF2.9
	3CA-PJ2	302-0205-0	RG-58/U	○		○		
	3CA-PJ2(05)	302-0205-0-05				○	○	
	UG-262/U	302-0007-7	RG-59/U, 62/U	○		○		
	BNC-PJ-58	302-0108-4	RG-55/U, 58/U	○		○		
	BNC-PJ-188/U	302-0230-8	RG-188A/U		○	○		
	BNC-PJ-196/U	302-0194-6	RG-196A/U	○			○	
	BNC-PJ-3DW	302-0236-4	3D-XW(lrrex cable)	○		○		
	3CW-PJ	302-0139-8	3C-2W	○		○		
	BNC-PJ-2.5DV	302-0238-0	2.5D-2V	○		○		
	BNC-PJ-1.5	302-0228-6	1.5D-2W		○	○		
	BNC-PJ-1.5W-1	302-0260-9				○	○	
BNC-PJ-1.5W-2	302-0282-1				○	○		
BNC-BPJ-1.5W	302-0284-7				○	○		
BNC-BPJ-1.5W-1	302-0289-0				○	○		

# BNC SERIES RF CO-AXIAL CONNECTORS

Type	Part No.	HRS No.	Applicable cable	Surface treatment				Remarks	
				Armor		Center contact			
				Silver	Nickel	Silver	Gold		
Panel jack	BNC-PJ-1.5DV-1	302-0285-0	1.5D-2V		○	○			
	BNC-BPJ-1.5-1	302-0252-0			○		○		
	3CV-PJ2	302-0204-8	3C-2V	○		○			
L-shaped Panel jack	BNC-LPJ-1.5	302-0255-9	1.5D-2V		○	○			
Receptacle	Flange type	UG-290/U	302-0009-2	4-M2.6×0.45	○		○		
		UG-290/U(04)	302-0009-2-04			○	○		
		3C-R	302-0031-1	4-φ3	○		○		
		3C-R(01)	302-0031-1-01	Ground lug plate	○		○		
		3C-R(03)	302-0031-1-03		○			○	
		3C-R(04)	302-0031-1-04	Ground lug plate		○	○		
		3C-R(07)	302-0031-1-07	Ground lug plate		○		○	
		3C-R(10)	302-0031-1-10		○		○		CO2SRF
		BNC-R-12	302-0229-9			○		○	
		BNC-R-13	302-0239-2			○		○	
	BNC-R-14	302-0245-5				○	○		
	Bulk head type	UG-604/U	302-0016-8		○		○		
		UG-625/U	302-0017-0		○		○		
		UG-625/U-(03)	302-0017-0-03			○		○	
		UG-625/U-4	302-0221-7			○	○		
		UG-625/U-10	302-0253-3	Fork terminal		○	○		
		UG-625/U-11A	302-0274-3			○	○		
		UG-657/U	302-0012-7	drip-proof type	○		○		
		UG-657/U(01)	302-0012-7-01	drip-proof type		○	○		
		UG-657/U-E	302-0080-7	drip-proof type	○		○		
UG-657/U-E(02)		302-0080-7-02	drip-proof type		○	○			

# BNC SERIES RF CO-AXIAL CONNECTORS

Type	Part No.	HRS No.	Applicable cable	Surface treatment				Remarks
				Armor		Center contact		
				Silver	Nickel	Silver	Gold	
Receptacle	Bulk head tape	UG-1094/U	302-0178-0		○		○	
		UG-1094/U(01)	302-0178-0-01			○	○	
		BNC-R-17A	302-0278-4	Fork terminal PBT		○	○	
		BNC-FBR(01)	302-0268-0-01	Insulation type PPO		○	○	
		BNC-FBR(02)	302-0268-0-02	Insulation type PPO		○		○
		BNC-FBR-DF1	302-0287-5	Insulation type, cable mount/dismount type		○	○	
		BNC-FBR-W	302-0279-7	Metal washer for BNC-FBR		○		
	L-shaped type	BNC-LR	302-0020-5		○		○	
		BNC-LR(03)	302-0020-5-03			○	○	
		BNC-LR(04)	302-0020-5-04	Marked with 3C-LR		○		○
	Plug type	BNC-BPR-3	302-0249-6			○		○
	Straight type for PCB	BNC-R-PC	302-0241-4			○	○	
		BNC-R-PC(01)	302-0241-4-01			○		○
		BNC-R-PC-2	302-0243-0			○	○	
		BNC-R-PC-7	302-0280-6			○	○	
	L-shaped type for PCB	BNC-LR-PC	302-0242-7			○	○	
		BNC-LR-PC(01)	302-0242-7-01			○		○
		BNC-LR-PC-1	302-0262-4			○	○	
		BNC-LR-PC-1(01)	302-0262-4-01			○		○
		BNC-LR-PC-3	302-0276-9			○	○	
	Ground lug plate	BNC-EL	302-0079-8		○			

# BNC SERIES RF CO-AXIAL CONNECTORS

Type	Part No.	HRS No.	Applicable cable	Surface treatment				Remarks
				Armor		Center contact		
				Silver	Nickel	Silver	Gold	
Adapter	BNC-A-JJ	302-0039-3		○		○		
	BNC-A-JJ-1	302-0050-6		○		○		
	BNC-A-JJ-1(01)	302-0050-6-01	Marked with 3C-A	○		○		
	BNC-A-JJ-1(10)	302-0050-6-10		○		○		CO2SAFF
	BNC-PA-JJ	302-0052-1		○		○		
	UG-414/U	302-0040-2	PA-JJ type	○		○		
	UG-414/U(06)	302-0040-2-06			○	○		
	UG-414/U(10)	302-0040-2-10	4-φ3.1	○		○		CO2PAFF
	UG-491/U	302-0022-0	A-PP type	○		○		
	UG-492/U	302-0021-8	Air-sealed	○		○		
L-shaped adapter	UG-306/U	302-0023-3	LA-PJ type	○		○		
	UG-306/U(03)	302-0023-3-03	Marked with 3C-LA	○		○		
	UG-306/U(10)	302-0023-3-10		○		○		CO2LAFM
T-shaped adapter	BNC-TA-JJJ	302-0024-6		○		○		
	UG-274/U	302-0025-9	(TA-JP type)	○		○		
	UG-274/U(01)	302-0025-9-01	Marked with BNC-TA-JPJ	○		○		
	UG-274/U(05)	302-0025-9-05			○		○	
U ring	BNC-UPA	302-0167-3	35-mm movable	○		○		
	BNC-UPA(01)	302-0167-3-01			○	○		
		-						
Cap	CW-123A/U	302-0041-5	For jack	○				
	CW-123A/U(10)	302-0041-5-10		○				CO2DC
Plug short	JCW-159/U	302-0026-1		○		○		
	JCW-159/U(03)	302-0026-1-03	No chain provided	○		○		

# BNC SERIES RF CO-AXIAL CONNECTORS

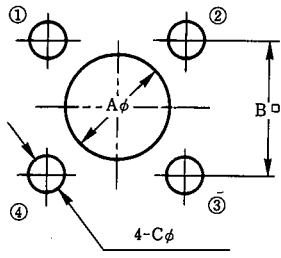

Fig. 1

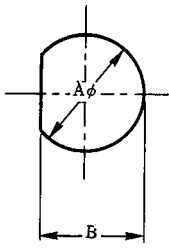

Fig. 2

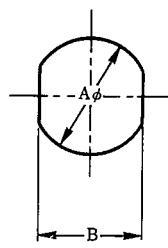

Fig. 3

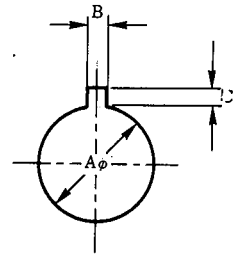

Fig. 4

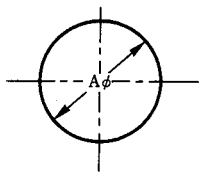

Fig. 5

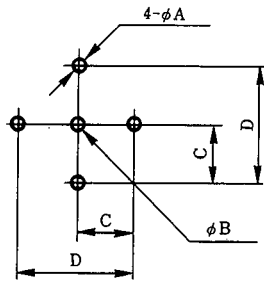

Fig. 6

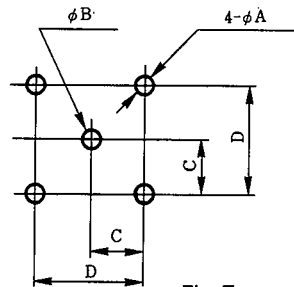

Fig. 7

Fig.	No.	A	B	C	D
1	1-1	11.4	12.7	3	—
	1-2	11.4	12.7	3.2	—
	1-3	9.8	12.7	3	—
	1-4	5.3	12.7	3	—
	1-5	12.3	12.7	3.2	—
	1-6	14.3	12.7	3.2	—
	1-7	9.8	12.7	3	—
	1-8	9.8	12.7	3.2	—
	1-9	9.8	12.7	$\frac{\textcircled{1}-\textcircled{3}}{3}$ $\frac{\textcircled{2}-\textcircled{4}}{3.2}$	—
	1-10	9	12.7	3	—
	1-11	9	12.7	3.2	—
	1-12	4.3	12.7	3.2	—
	1-13	15	18.2	3.4	—
	1-14	7	12.7	3	—

Fig.	No.	A	B	C	D
2	2-1	$9.6^{+0.1}_0$	$9^{+0.1}_0$	—	—
	2-2	$9.6^{+0.1}_0$	$8.5^{+0.1}_0$	—	—
	2-3	$11.3^{+0.1}_0$	$10.3^{+0.1}_0$	—	—
	2-4	$9.6^{+0.1}_0$	$8.8^{+0.1}_0$	—	—
	2-5	$12.1^{+0.1}_0$	$11.1^{+0.1}_0$	—	—
3	3-1	$9.6^{+0.1}_0$	$8.1^{+0.1}_0$	—	—
	3-2	$9.6^{+0.1}_0$	$8.3^{+0.1}_0$	—	—
	3-3	$9.6^{+0.1}_0$	$8.6^{+0.1}_0$	—	—
4	4-1	$12.7^{+0.1}_0$	$1.3^{+0.1}_0$	$1.8^{+0.1}_0$	—
5	5-1	$12.7^{+0.1}_0$	—	—	—
6	6-1	$1.6^{+0.1}_0$	$1.6^{+0.1}_0$	$5.08 \pm 0.05$	$10.16 \pm 0.05$
7	7-1	$1.8^{+0.1}_0$	$1.8^{+0.1}_0$	$5.08 \pm 0.05$	$10.16 \pm 0.05$
	7-2	$1.4^{+0.1}_0$	$1.4^{+0.1}_0$	$3.81 \pm 0.05$	$7.62 \pm 0.05$

# BNC SERIES RF CO-AXIAL CONNECTORS

## Functional drawing

Typical part numbers are enclosed in parentheses

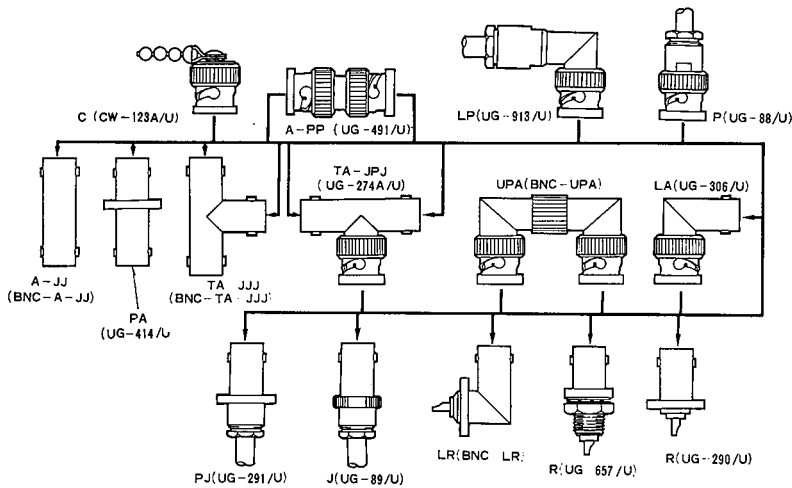

**Table 1. End processing dimensions arranged by part number**

(Unit : mm)

HRS No.	Part No.	$L_1 \pm 0.5$	$L_2 \pm 0.1$	$L_3$
*CL302-0001-0	UG-88/U	7.5	3	2.9
*CL302-0002-3	UG-260/U	7.6	3	2.9
CL302-0006-4	3CV-J	7.4	3	3.2
CL302-0007-7	UG-262/U	7.3	3	2.9
CL302-0034-0	UG-89/U	7.5	3	2.9
CL302-0035-2	UG-261/U	7.3	3	2.9
*CL302-0036-5	UG-291/U	7.5	3	2.9
*CL302-0043-0	UG-913/U	7.4	3	2.4
*CL302-0070-3	UG-88D/U	7.6	3	2.7
*CL302-0129-4	3DW-P2	10	3	5
*CL302-0132-9	BNC-P-5DV	11.4	2.5	5
*CL302-0152-6	3CF-P	10	3	5
*CL302-0157-0	3CV-PL	9.4	1.8	5.3
*CL302-0202-2	3CV-P2	9.6	3	5
*CL302-0203-5	3CA-P2	9.6	3	5
*CL302-0204-8	3CV-PJ2	7	3	2.8
*CL302-0205-0	3CA-PJ2	7	3	2.8
*CL302-0209-1	3CW-P	10.4	3	5
CL302-0210-0	3CT-P	10.9	3	5

\*Standard product

## Connecting methods

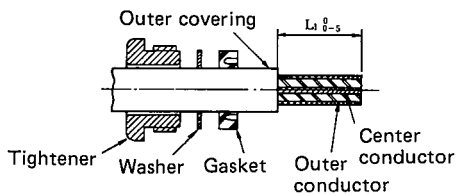

The ends are processed as shown in the drawing (refer to Table 1). For the end processing dimensions  $L_1$ , refer to Table 1, End processing dimensions arranged by part number.

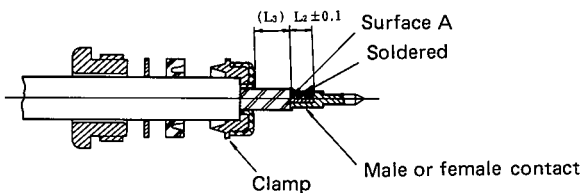

- (1) Insert clamp from tip of cable and fold outer conductor of cable back onto clamp. Using a knife, cut off excess outer conductor left at this time.
- (2) Cut off center conductor of cable at  $L_2$ , from surface A of cable insulation. For end processing dimensions  $L_2$ ,  $L_3$ , refer to Table 1, End processing dimensions arranged by part ( $L_3$  is a reference dimension.)  
(Note: Be careful not to damage center conductor.)
- (3) Solder contact and center conductor. It is a good idea at this time to solder the terminal preliminarily in advance.  
(Note: There must be no gap between the end and the cable insulation.)



Insert cable and parts into shell and tighten tightening nut sufficiently.

# BNC SERIES RF CO-AXIAL CONNECTORS

## Assembling methods

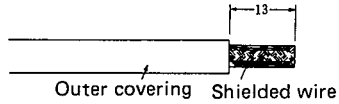

1. Cut off 13mm of the cable's outer covering and expose the shielded wire.

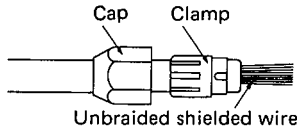

2. Put the cap through the cable, insert the clamp, and unbraided the shielded wire.

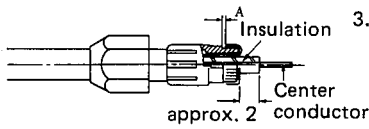

3. Wind the shielded wire onto the clamp. At this time, cut off the shielded wire at position A in the drawing, leaving some gap.

4. Cut off the insulation, leaving about 2mm of it.

Fit tightly, trying to leave as little gap as possible.

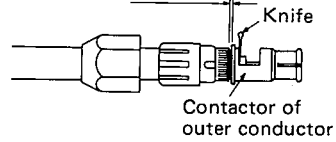

5. Fit the contactor of the outer conductor tightly onto the clamp, position a knife on the notched window, and cut off the insulation. Take care not to damage the center conductor at this time.

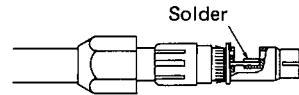

6. Solder the center conductor with the contactor of the outer conductor fitting tightly onto the clamp.

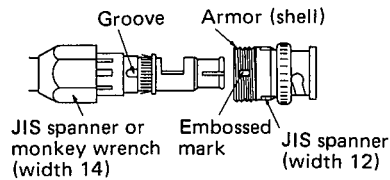

7. Insert the block described above so that it will fit into the groove on the clamp and the embossed mark on the armor. Tighten the cap thoroughly. The tools used are a JIS spanner (width 12) and a JIS spanner or monkey wrench (width 14).