

Multi DomiLED[™]

Synonymous with function and performance, the Multi DomiLED[™] series is perfectly suited for a variety of cross-industrial applications due to its small package outline, durability and superior brightness.



Features:

- > High brightness tri-color surface mount LED.
- > Each color can be individually controlled
- > 120° viewing angle.
- > Small package outline (LxWxH) of 3.2 x 3.0 x 1.7mm.
- > Qualified according to JEDEC moisture sensitivity Level 2.
- > Compatible to IR reflow soldering.
- > Environmental friendly; RoHS compliance.



Applications:

- > Automotive: interior, eg: backlighting of display --> navigation system
- > Signs: full color video
- > Consumer & Communication: backlighting of LCDs
- > General Lighting: architectural lighting, decorative lighting



Optical Characteristics at Tj=25°C

Part Ordering Number	Color, λ_{dom} (nm)			Luminous Intensity @ IF = 20mA IV (mcd)								
	Chip #1	Chip #2	Chip #3	Chip #1			Chip #2			Chip #3		
				Min.	Typ.	Max.	Min.	Typ.	Max.	Min.	Typ.	Max.
D6RTB-HJD-TU+UV+ST-1	Red 625nm	True Green 525nm	Blue 465nm	320.0	450.0	637.0	715.0	1012.0	1400.0	202.0	285.0	405.0
● D6RTB-HJD-TU+UV+RS-1	Red 625nm	True Green 525nm	Blue 465nm	320.0	450.0	637.0	715.0	1012.0	1400.0	140.0	202.0	285.0

● Not for new design

NOTE:

1. Reel comes in a quantity of 1000 units per reel.
2. Luminous intensity is measured with an accuracy of $\pm 11\%$.

Electrical Characteristics at Tj=25°C

	Vf @ If = 20mA			Vr @ Ir = 10uA
	Min. (V)	Typ. (V)	Max. (V)	Min. (V)
Red	2.00	2.10	2.60	12
True Green	3.00	3.20	3.60	5
Blue	3.00	3.20	3.60	5

Forward voltage, Vf is measured with an accuracy of ± 0.1 V.

Absolute Maximum Ratings

	Maximum Value	
DC forward current	Red; AllInGaP=30; True Green, Blue; InGaN=25	mA
Peak pulse current; (tp \leq 10 μ s, Duty cycle = 0.005)	Red ; AllInGaP=500; True Green, Blue; InGaN=200	mA
Reverse voltage	Red; AllInGaP=12; True Green, Blue; InGaN= 5	V
ESD threshold (HBM)	2000	V
LED junction temperature	125	°C
Operating temperature	-40 ... +100	°C
Storage temperature	-40 ... +100	°C
Thermal resistance		
- Junction / ambient, R _{thJA} (3 chips On)	600	K/W
- Junction / solder point, R _{thJS} (3 chips On)	180	K/W
(Mounting on FR4 PCB, pad size \geq 16 mm ² per pad)		

Characteristics

	Symbol		Value	Unit
Temperature coefficient of λ_{dom} (typ) $I_F = 20\text{mA}; 0\text{ }^\circ\text{C} \leq T \leq 100\text{ }^\circ\text{C}$	$TC_{\lambda_{dom}}$ (typ)	Red	0.06	nm / K
		True Green	0.04	nm / K
		Blue	0.03	nm / K
Temperature coefficient of V_F (typ) $I_F = 20\text{mA}; 0\text{ }^\circ\text{C} \leq T \leq 100\text{ }^\circ\text{C}$	TC_V	Red	-2.9	mV / K
		True Green	-2.3	mV / K
		Blue	-2.3	mV / K
Temperature coefficient of I_V (typ) $I_F = 20\text{mA}; 0\text{ }^\circ\text{C} \leq T \leq 100\text{ }^\circ\text{C}$	TC_{I_V}	Red	-3.0	mcd / K
		True Green	-2.1	mcd / K
		Blue	-0.1	mcd / K

Wavelength Grouping at $T_j=25^\circ\text{C}$

Color	Group	Wavelength distribution (nm)
Red	Full	620 - 630
True Green	Full	521 - 536
	A	521 - 526
	B	526 - 531
	C	531 - 536
Blue	Full	465 - 475
	A	465 - 470
	B	470 - 475

Dominant wavelength is measured with an accuracy of $\pm 1\text{nm}$.

Luminous Intensity Group at Tj=25°C

Only one IV group is allowed for each chip within reel.

Brightness Group	Luminous Intensity @ IV (mcd)		
	Chip #1	Chip #2	Chip #3
T3U3S3	320.0...450.0	715.0...1012.0	202.0...285.0
T3U3T4	320.0...450.0	715.0...1012.0	285.0...405.0
T3V3S3	320.0...450.0	1012.0...1400.0	202.0...285.0
T3V3T4	320.0...450.0	1012.0...1400.0	285.0...405.0
U3U3S3	450.0...637.0	715.0...1012.0	202.0...285.0
U3U3T4	450.0...637.0	715.0...1012.0	285.0...405.0
U3V3S3	450.0...637.0	1012.0...1400.0	202.0...285.0
U3V3T4	450.0...637.0	1012.0...1400.0	285.0...405.0
T3U3R3	320.0...450.0	715.0...1012.0	140.0...202.0
T3U3S3	320.0...450.0	715.0...1012.0	202.0...285.0
T3V3R3	320.0...450.0	1012.0...1400.0	140.0...202.0
T3V3S3	320.0...450.0	1012.0...1400.0	202.0...285.0
U3U3R3	450.0...637.0	715.0...1012.0	140.0...202.0
U3U3S3	450.0...637.0	715.0...1012.0	202.0...285.0
U3V3R3	450.0...637.0	1012.0...1400.0	140.0...202.0
U3V3S3	450.0...637.0	1012.0...1400.0	202.0...285.0

Luminous intensity is measured with an accuracy of ± 11%.

Correlation Between Luminous Intensity And Luminous Flux at Tj=25°C

Color	IV Bin	Luminous Intensity (mcd)		Correlated Luminous Flux (lm)		Typical Efficiency @ IF = 20mA (Lm /W)
		Min	Max	Min	Max	
Red	T3	320	450	0.80	1.13	30
	U3	450	637	1.13	1.59	
True Green	U3	715	1012	1.79	2.53	40
	V3	1012	1400	2.53	3.50	
Blue	R3	140	202	0.35	0.51	12
	S3	202	285	0.51	0.72	
	T4	285	405	0.72	1.02	

Note: Data provided above is based on approximation

Relative Intensity Vs Forward Current (Red)

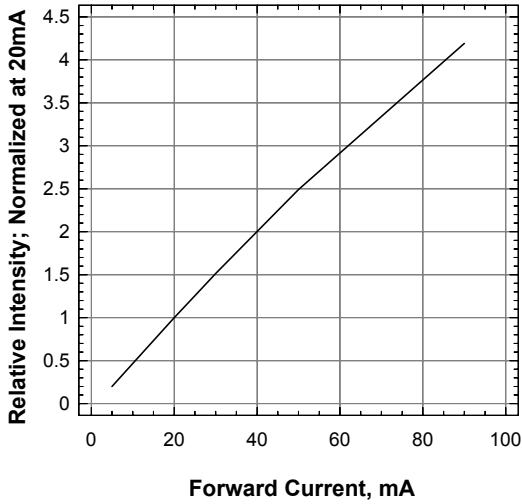

Relative Intensity Vs Forward Current (Blue and True Green)

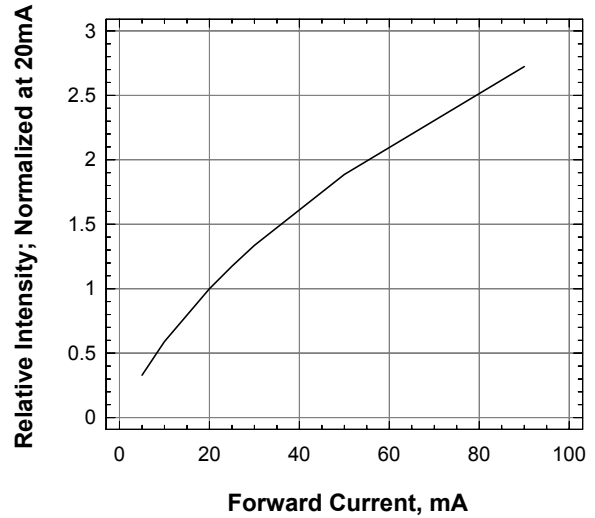

Forward Current Vs Forward Voltage (Red)

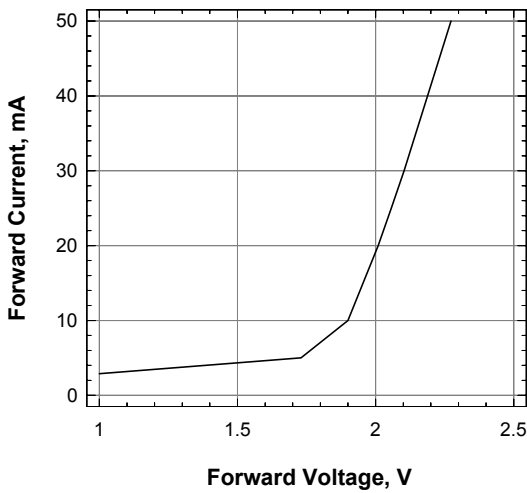

Forward Current Vs Forward Voltage (Blue and True Green)

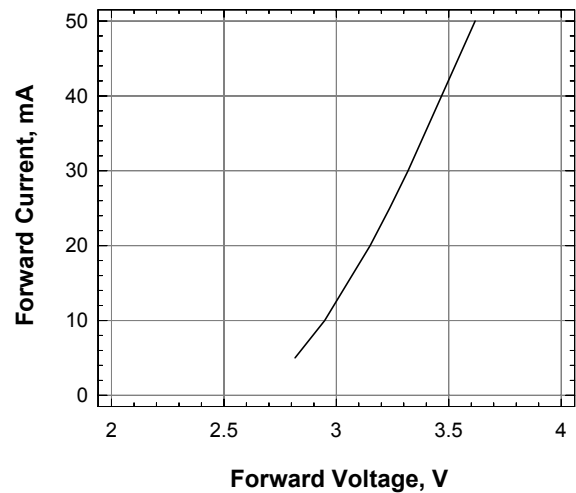

Wavelength Shift Vs Forward Current (Blue)

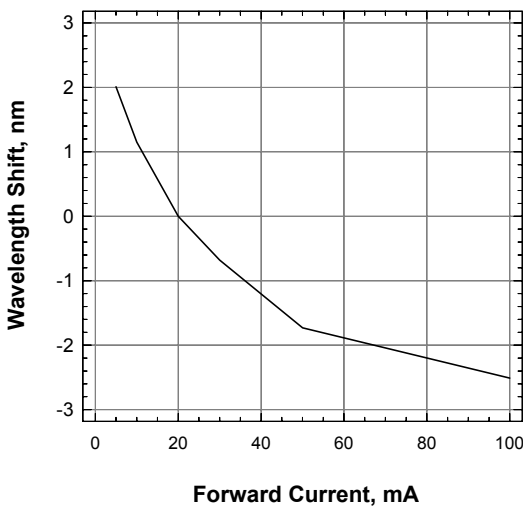

Wavelength Shift Vs Forward Current (True Green)

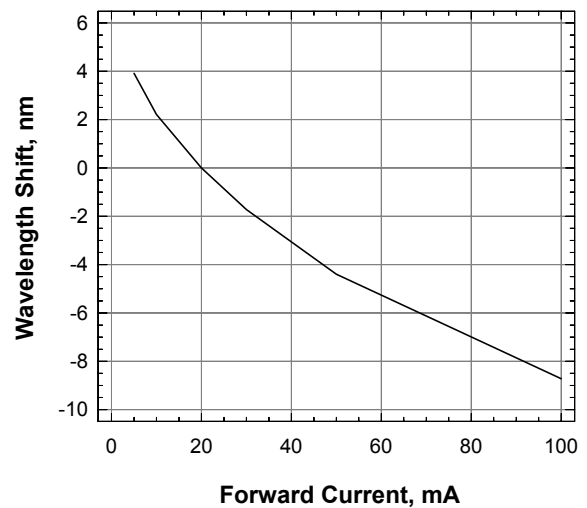

Relative Intensity vs Wavelength

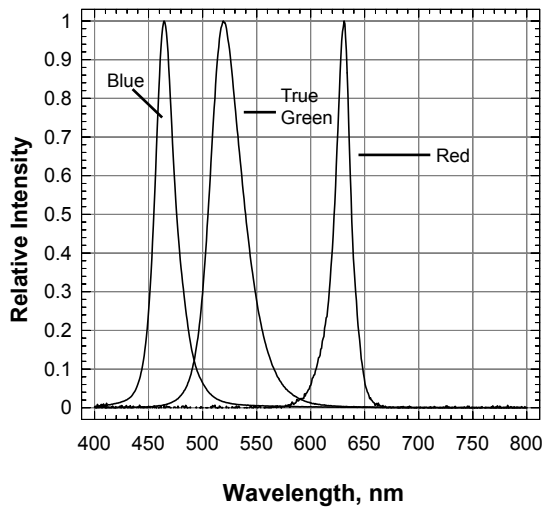

Maximum Permissible Forward Current

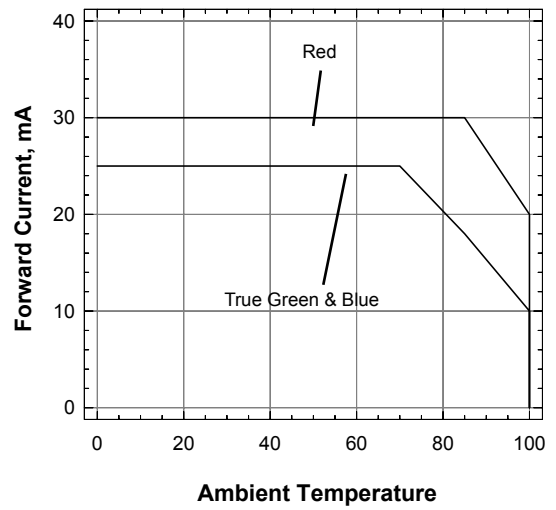

Allowable Forward Current Vs Duty Ratio

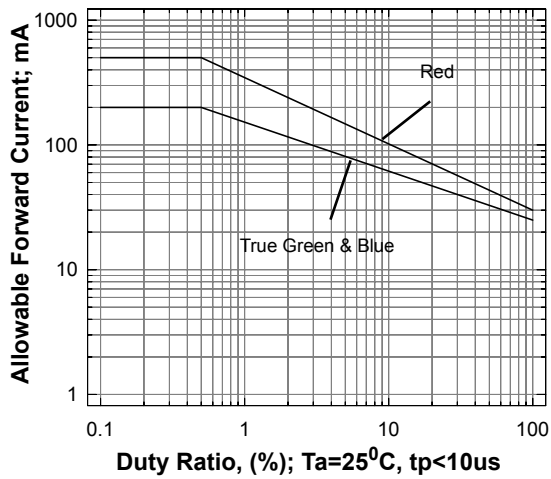

Radiation Pattern

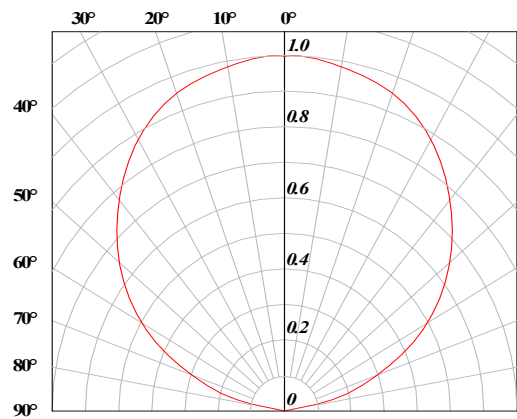

Multi DomiLED™ : D6RTB-HJD Package Outlines

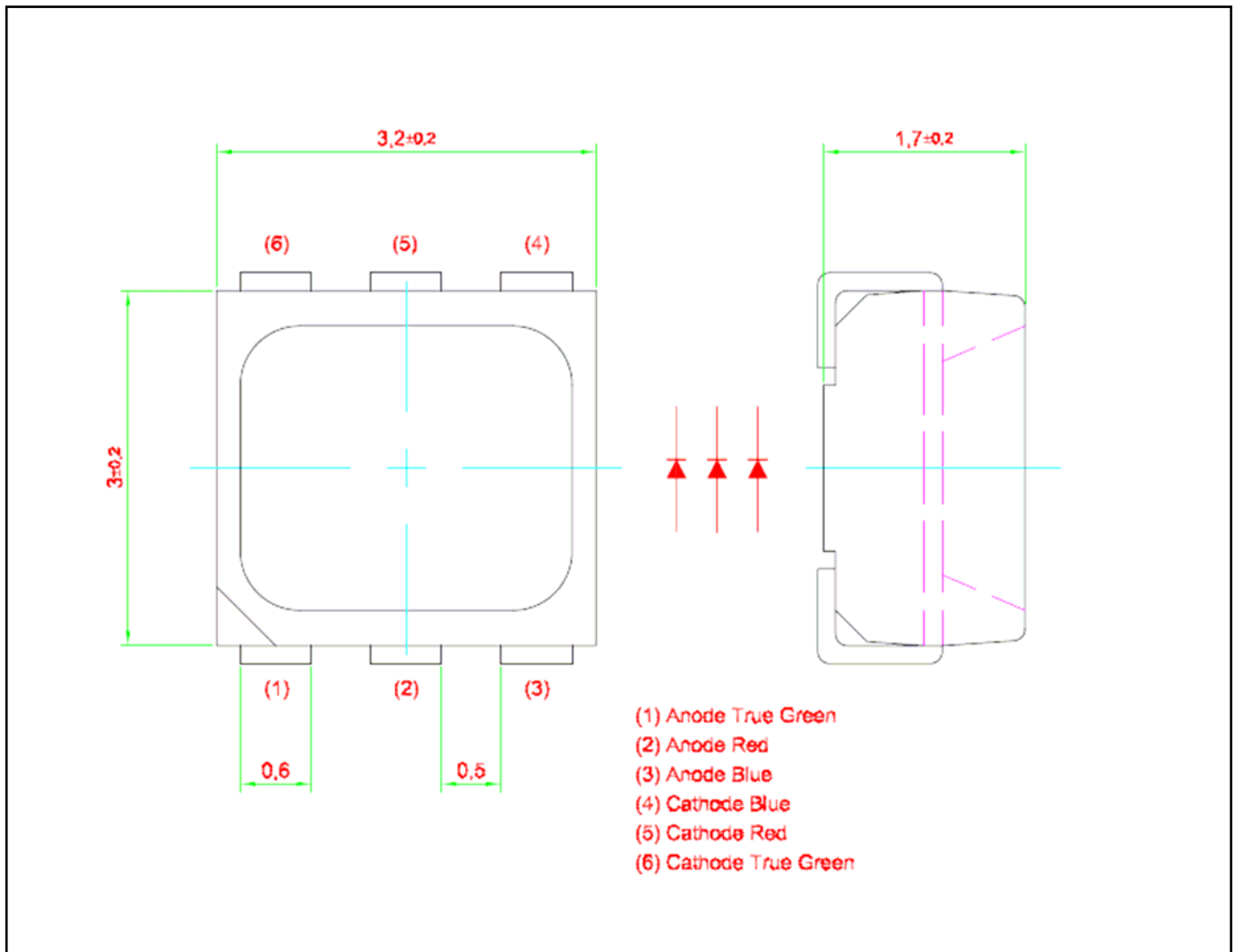

Materials

Materials	
Lead Frame	Copper alloy
Housing	High temperature resistant plastic, PPA
Encapsulant	Silicone resin
Lead-finishing	Pure tin plating, Sn

Note: Package is Pb-free.

Recommended Solder Pad

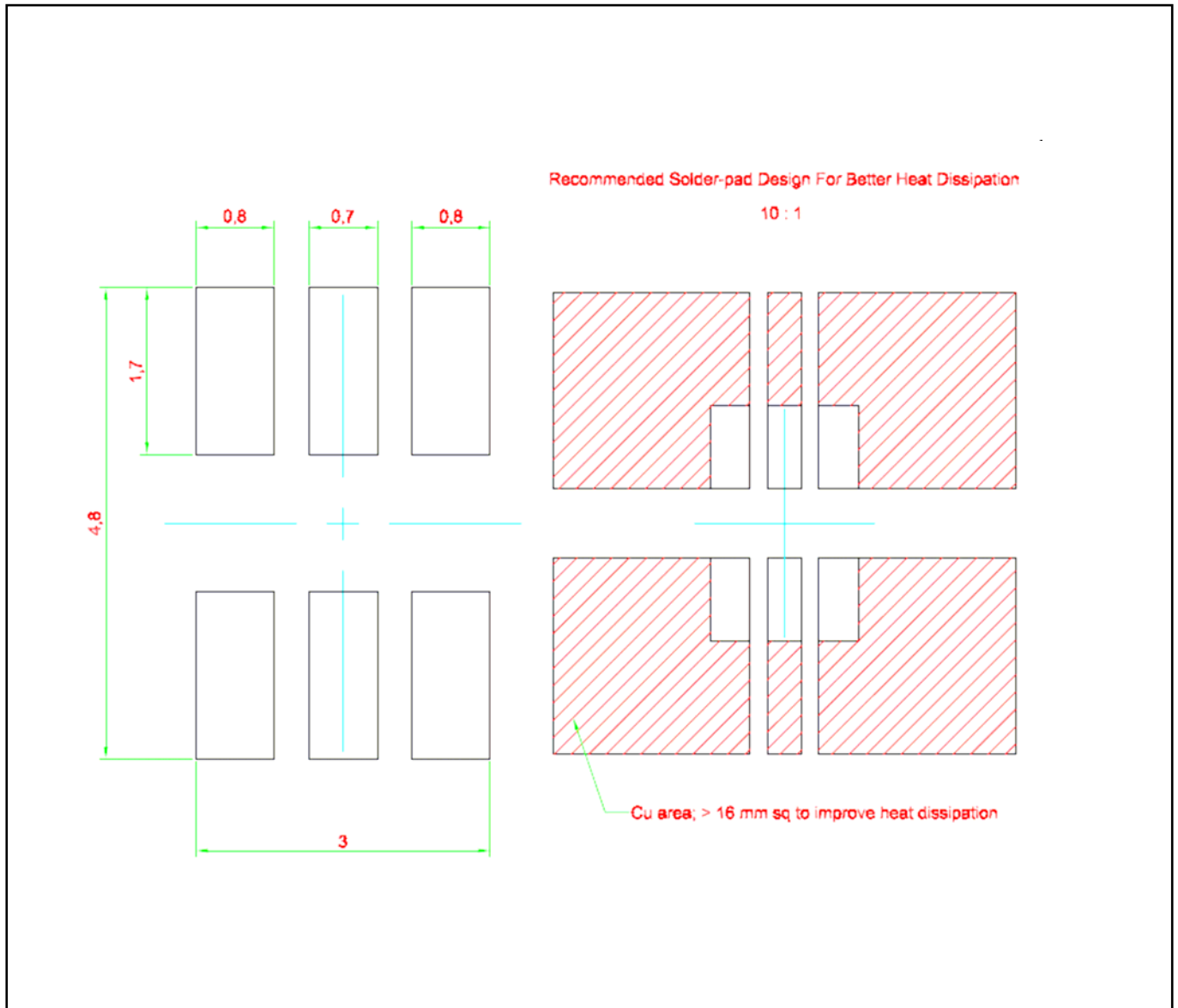

Taping and orientation

- Reels come in quantity of 1000 units.
- Reel diameter is 180 mm.

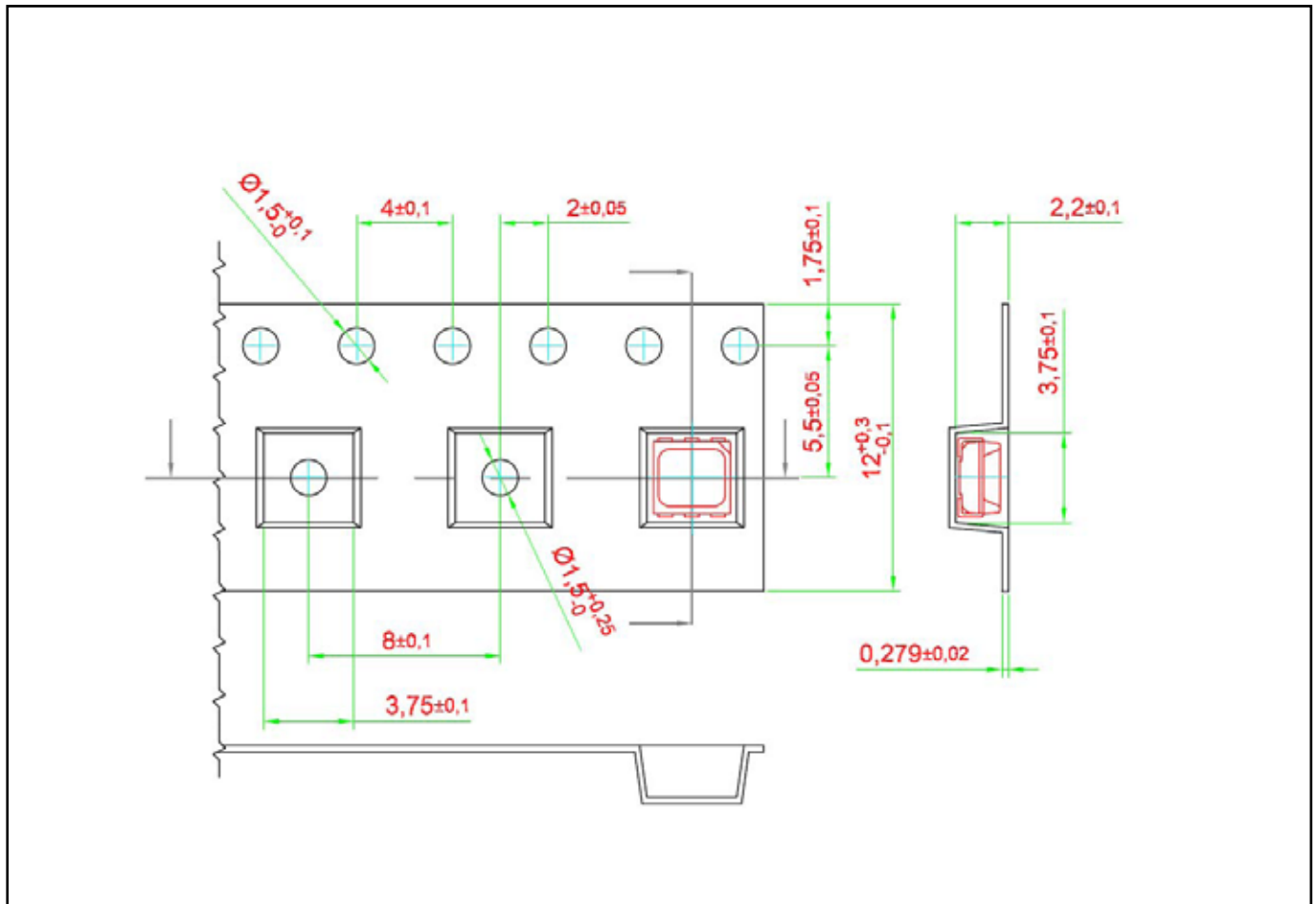

Packaging Specification

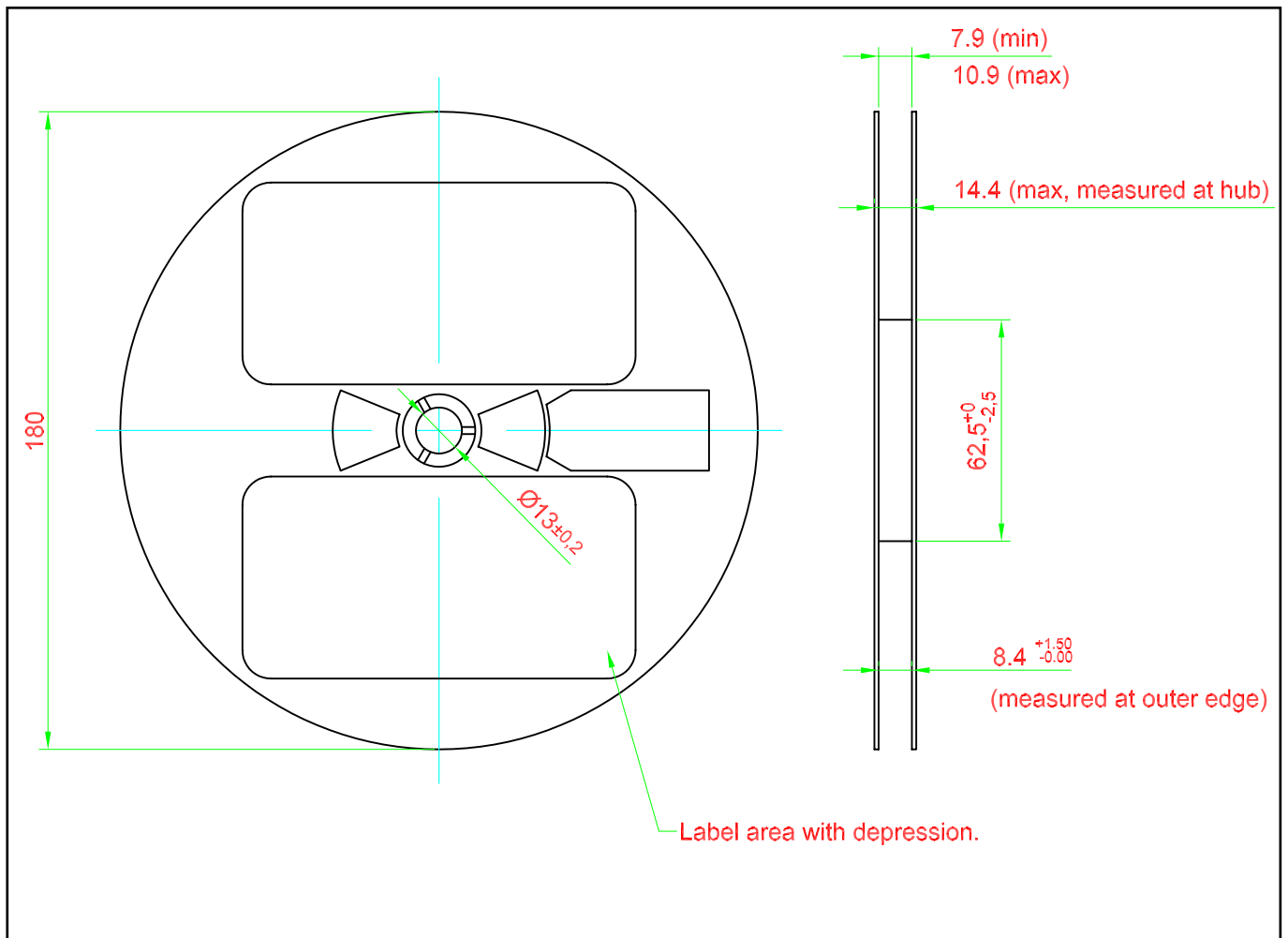

Packaging Specification

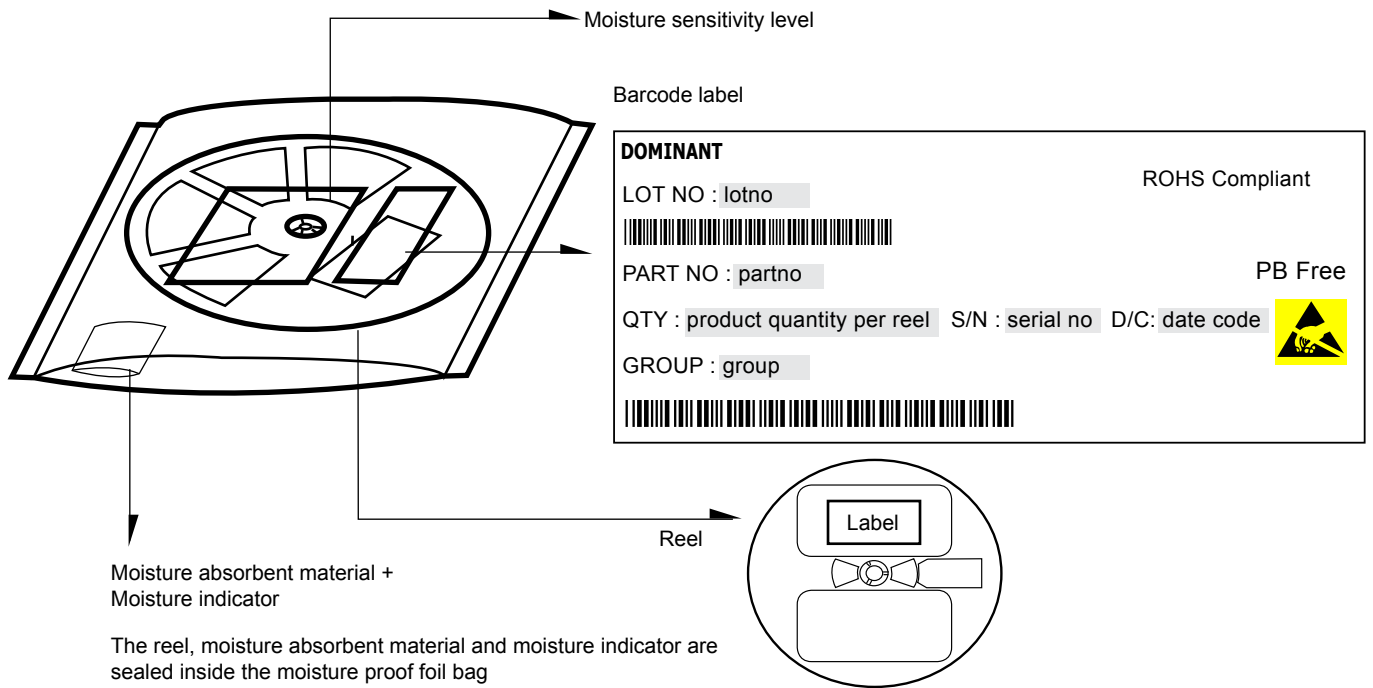

	Average 1pc DomiLED/Multi DomiLED	1 completed bag (1000pcs)
Weight (gram)	0.034	100 ± 10

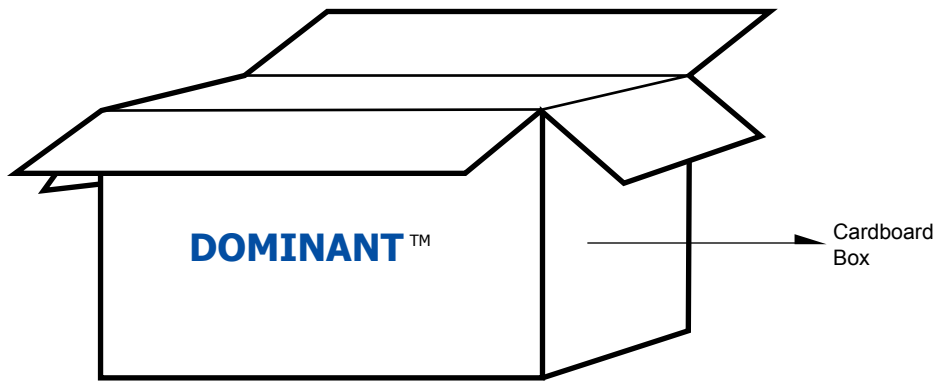

For Multi DomiLED™

Cardboard Box Size	Dimensions (mm)	Empty Box Weight (kg)	Reel / Box	Quantity / Box (pcs)
Small	300 x 250 x 250	0.58	15 reels MAX	15,000 MAX
Large	416 x 516 x 476	1.74	50 reels MAX	50,000 MAX

Recommended Sn-Pb IR-Reflow Soldering Profile

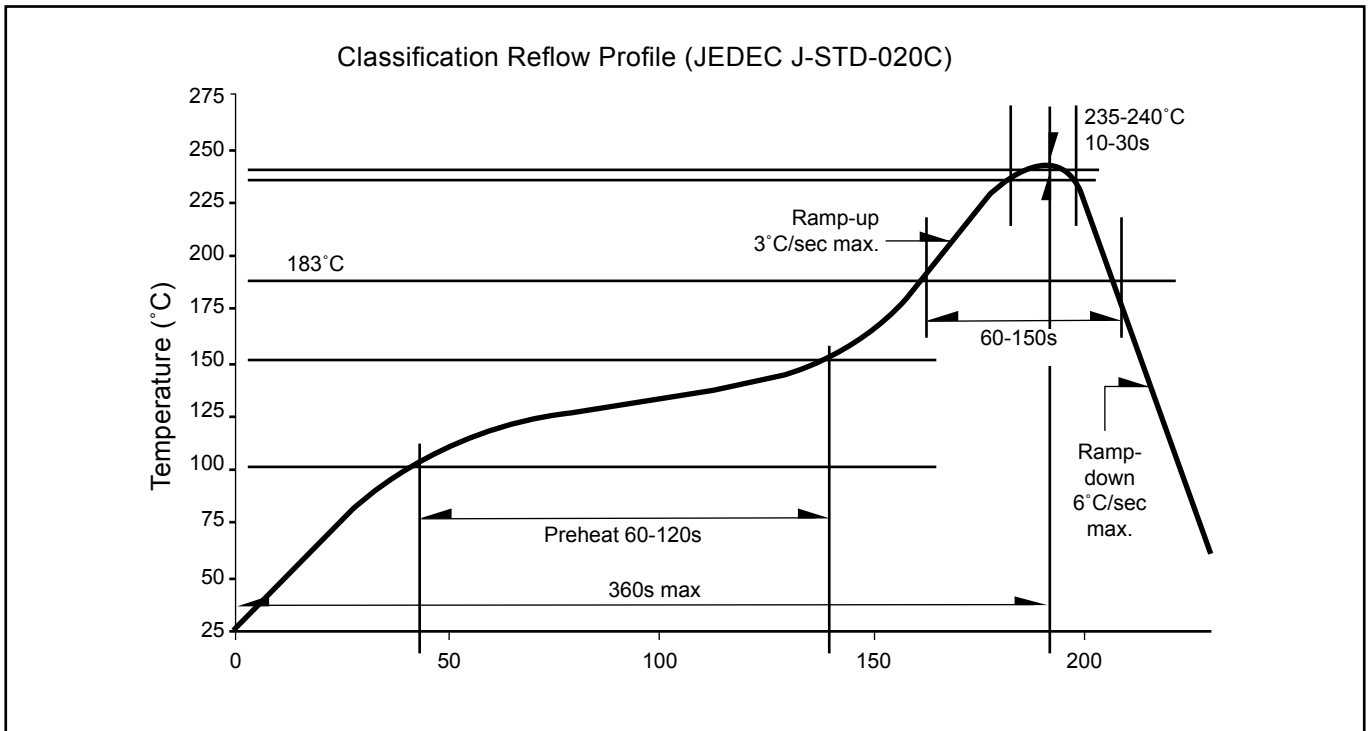

Recommended Pb-free Soldering Profile

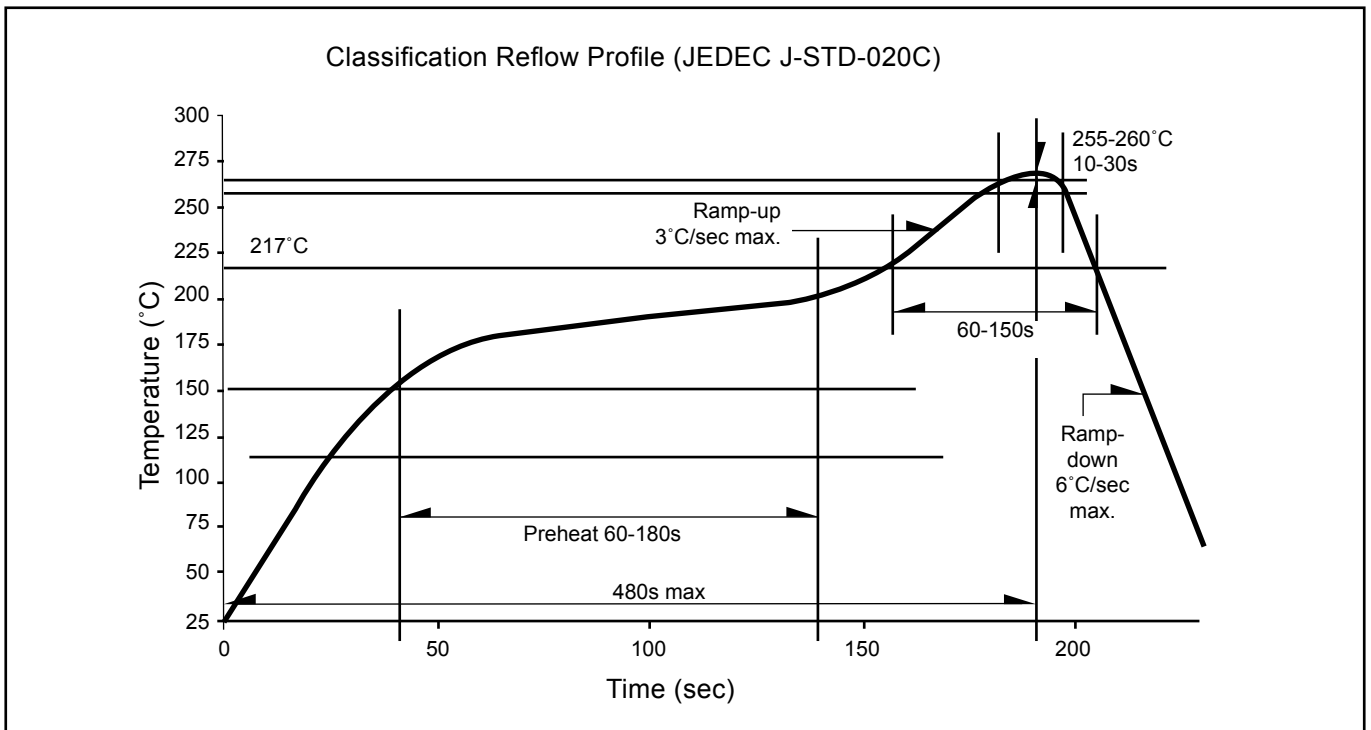

Revision History

Page	Subjects	Date of Modification
-	Initial Release	11 Feb 2008
4	Add Characteristics Table	15 May 2008
6	Add Allowable Forward Current Vs Duty Ratio Graph	27 Apr 2009
2	Add reverse current	02 Jul 2009
2	Add new partno: D6RTB-HJD-TU+UV+ST-1 Not for new design: D6RTB-HJD-TU+UV+RS-1	15 Jan 2010
2	Add Thermal Resistance	29 Jan 2010
-	Update company name	04 May 2010

NOTE

All the information contained in this document is considered to be reliable at the time of publishing. However, DOMINANT Opto Technologies does not assume any liability arising out of the application or use of any product described herein.

DOMINANT Opto Technologies reserves the right to make changes at any time without prior notice to any products in order to improve reliability, function or design.

DOMINANT Opto Technologies products are not authorized for use as critical components in life support devices or systems without the express written approval from the Managing Director of DOMINANT Opto Technologies.

About Us

DOMINANT Opto Technologies is a dynamic Malaysian Corporation that is among the world's leading SMT LED Manufacturers. An excellence – driven organization, it offers a comprehensive product range for diverse industries and applications. Featuring an internationally certified quality assurance acclaim, DOMINANT's extra bright LEDs are perfectly suited for various lighting applications in the automotive, consumer and communications as well as industrial sectors. With extensive industry experience and relentless pursuit of innovation, DOMINANT's state-of-art manufacturing, research and testing capabilities have become a trusted and reliable brand across the globe. More information about DOMINANT Opto Technologies can be found on the Internet at <http://www.dominant-semi.com>.

Please contact us for more information:

Head Quarter

DOMINANT Opto Technologies Sdn. Bhd.
Lot 6, Batu Berendam, FTZ Phase III, 75350 Melaka, Malaysia
Tel: (606) 283 3566 Fax: (606) 283 0566
E-mail: sales@dominant-semi.com

DOMINANT Semiconductors Malaysia Sdn. Bhd. Shanghai Representative Office

DOMINANT Semiconductors (Shenzhen) Co. Ltd.
Rm 1007, DaZhong Building, No. 1515 Zhong Shan (W) Rd, Shanghai, China 200235
Tel: +86 21 6428 6428 Fax: +86 21 6428 6880
E-mail: sales_china@dominant-semi.com

DOMINANT Korea Sales Office

DOMINANT Semiconductors Korea Inc.
RM 211 SUNTEAK CITY APT. 513-15 Sangdaewon-dong, Jungwon-gu, Seongnam-si, Gyeonggi-do, 462-725, Korea
Tel: +82-31-701-5203 Fax: +82-31-701-5204
E-mail: sales_korea@dominant-semi.com

DOMINANT U.S.A Sales Office

25 Rockaway Road, 08833 Lebanon, New Jersey, USA
Tel: (908) 439-9930 Cell: (908) 343-5810 Fax: (908) 439-9929
E-mail: don.wendel@dominant-semi.com

DOMINANT Europe Sales Office

DOMINANT Semiconductors Europe GmbH
Raiffeisenstr. 38, 74906 Bad Rappenau Germany
Tel: +49 (0) 7264-89010-10 / +49 (0) 7264-89010-11 Cell: +49 173-6907370 / +49 173-6907751
Fax: +49 (0) 7264-89010-29
E-mail: gerd.wachno@dominant-semi.eu; hartmut.wettengl@dominant-semi.eu

DOMINANT India Sales Office

C-11, Vasanth Business Centre #86, TTK Road, Alwarpet Chennai - 600 018, INDIA
Tel: 91-44-42030616 / 516 Cell: 91-9444920537 Fax: 91-9444920616
E-mail: pravat.behera@dominant-semi.com

