

FCC17

FILTERED DUAL PORT D-SUB CONNECTORS

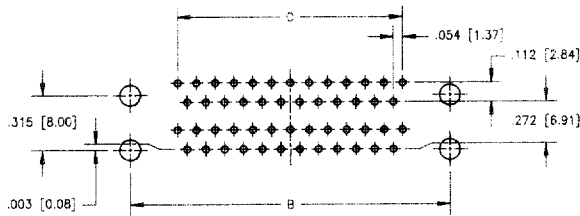
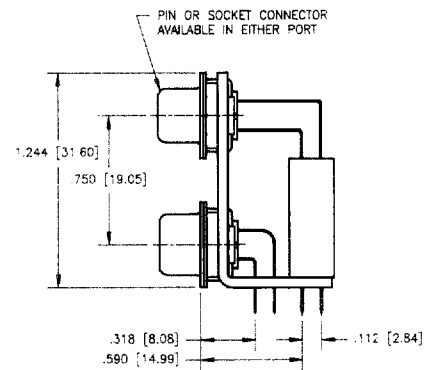
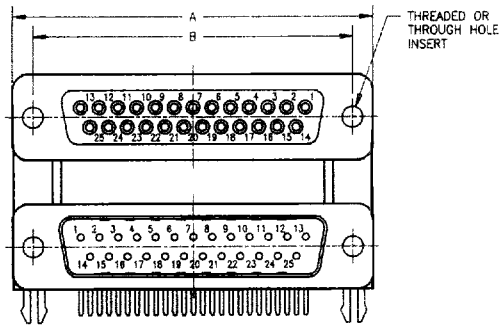

Dimensions

Connector size	A	B	C
9	1.213 [30.81]	.984 [24.99]	.432 [10.97]
15	1.541 [39.14]	1.312 [33.32]	.756 [19.20]
25	2.088 [53.04]	1.852 [47.04]	1.304 [33.12]

PC.B. LAYOUT

HOW TO ORDER DUAL PORT D-SUB

<p>FCC17 Series Designation</p> <p>2 Vertical Mounting Dimension Between Connectors of .750" (other options available)</p> <p>BP Upper Connector Configuration (Size and Style) EP: 9 pin ES: 9 socket AP: 15 pin AS: 15 socket BP: 25 pin BS: 25 socket</p> <p>BS Lower Connector Configuration (Size and Style) same as Upper Connector Configuration</p> <p>-4 Mounting 2: .120" [3.05 mm] Diameter Through Hole on Flanges 4: 4-40 Threaded Inserts on Flanges E: 4-40 Hex Jack Sockets</p>	<p>1 5 0 0</p> <p>Modifier: 0: Standard Product x: Special or Custom Versions</p> <p>Lower Connector Filter Capacitance: same as Upper Connector Filter Capacitance Designation</p> <p>Upper Connector Filter Capacitance: D: 50 pF 5: 1000 pF 0: 180 pF E: 2200 pF 1: 470 pF 9: 5600 pF 4: 820 pF 8: 47,000 pF</p>
---	--

FCC17

FILTERED D-SUB CONNECTORS

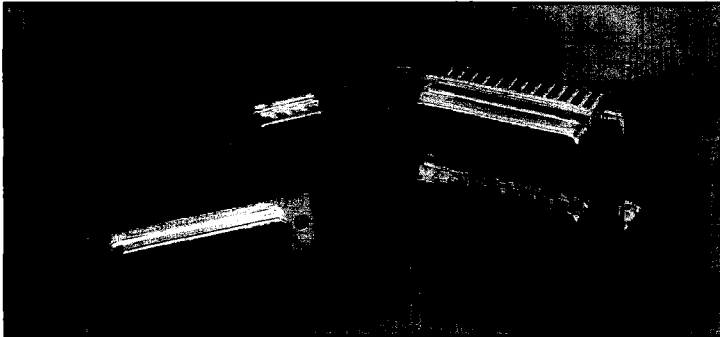

These products are protected by U.S. Patent # 4500159

Filter Characteristics: See Page 2
Electrical Data: See Page 2
Material and Finishes: See Page 3
Environmental Data: See Page 3
UL File #: E135615
CSA File #: LR68598

HOW TO ORDER D-SUB

FCC17 Series Designation	FCC17 - B25 P A -4 1 0 G
B25 Size: E09, A15, B25, C37	
P Connector Style: P - Pin, S - Socket, A - Adapter	
A Termination Type: A - Right Angle PC Tail, .318" [8.08 mm] Footprint B - Right Angle PC Tail, .405" [10.29 mm] Footprint C - Right Angle PC Tail, .590" [14.99 mm] Footprint D - Pin/Socket Adapter E - Vertical Mount PC Tail M - Solder Cup N - Long Body, Vertical Mount PC Tail	G Gold Content on Contacts: No Digit: 15µ inches [0.38 microns] G: 50µ inches [1.27 microns]
-4 Mounting (on flange): A: Vertical Mount, 4-40 Threaded PC Tail Standoffs with Boardlock 2: .120" [3.05 mm] Diameter Through Hole 4: 4-40 Threaded Inserts (self-locking inserts available) 6: M3 Threaded Inserts E: 4-40 Hex Jack Sockets	0 Modifier: 0 = Standard Product (Boardlocks on Right Angle D-Subs) B = Metal Mounting Brackets, for Right Angle D-Subs x = Special or Custom Versions
	1 Filter Capacitance: D: 50 pF 5: 1000 pF 0: 180 pF E: 2200 pF 1: 470 pF 9: 5600 pF 4: 820 pF 8: 47,000 pF

MOUNTING DIMENSIONS

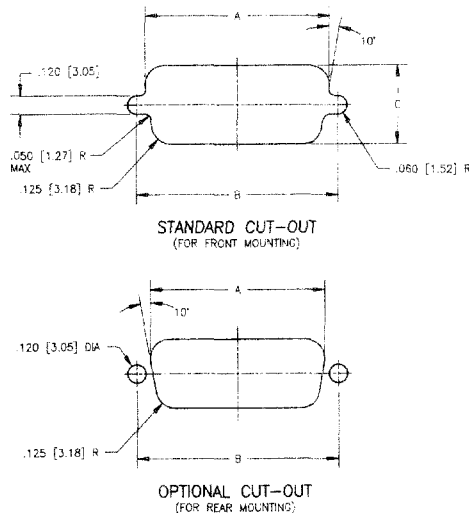

Size	Mounting	A	B	C
9	Front	.875 [22.23]	.984 [24.99]	.512 [13.00]
	Rear	.807 [20.50]	.984 [24.99]	.449 [11.40]
15	Front	1.200 [30.48]	1.312 [33.32]	.512 [13.00]
	Rear	1.134 [28.80]	1.312 [33.32]	.449 [11.40]
25	Front	1.744 [44.30]	1.852 [47.04]	.512 [13.00]
	Rear	1.673 [42.49]	1.852 [47.04]	.449 [11.40]
37	Front	2.389 [60.68]	2.500 [63.50]	.512 [13.00]
	Rear	2.326 [59.08]	2.500 [63.50]	.449 [11.40]

FCC17

9 SIZE

FILTERED D-SUB CONNECTORS

SOCKET

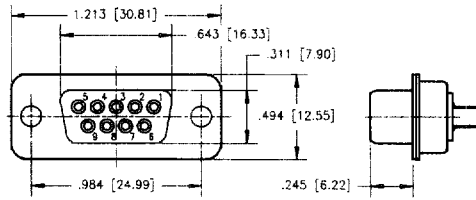

PIN

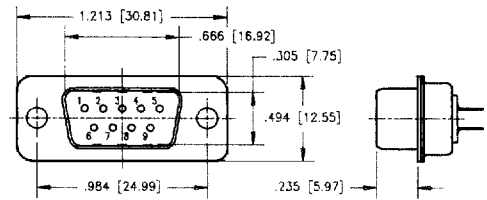

PIN-TO-SOCKET ADAPTER

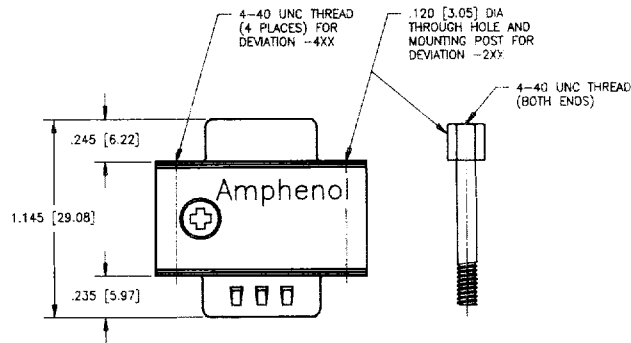

Mounting Options

4-40 Threaded Inserts:

FCC17-E09AD-4x0

Through Hole with Mounting Post:

FCC17-E09AD-2x0

SOLDER CUP TERMINATION

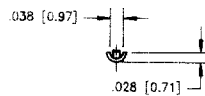
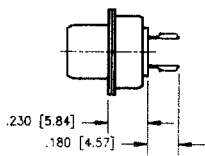

SOLDER CUP DETAIL
(ACCEPTS UP TO 20 AWG WIRE)

Pin: FCC17-E09PM-xx0

Socket: FCC17-E09SM-xx0

xx = To complete the P/N, see page 5 to assign Mounting Code and Filter Capacitance.
For electrical and mechanical specifications, see pages 2 and 3.

9 SIZE

FCC17

FILTERED D-SUB CONNECTORS

PC TAIL TERMINATION

VERTICAL MOUNT

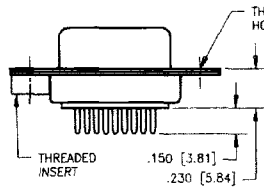

Pin: FCC17-E09PE-**xx**0
Socket: FCC17-E09SE-**xx**0

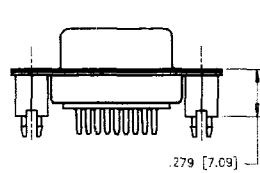

Pin: FCC17-E09PE-A**xx**0
Socket: FCC17-E09SE-A**xx**0

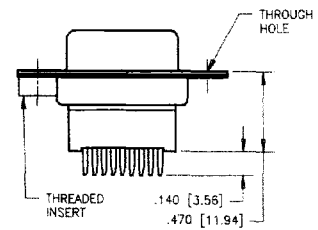

Pin: FCC17-E09PN-**xx**0
Socket: FCC17-E09SN-**xx**0

RIGHT ANGLE, WITH BOARDLOCKS

.318" Footprint

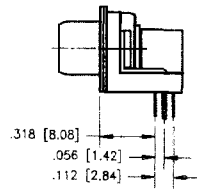

Pin: FCC17-E09PA-**xx**0
Socket: FCC17-E09SA-**xx**0

.405" Footprint

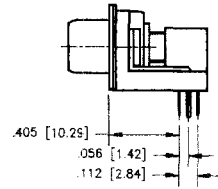

Pin: FCC17-E09PB-**xx**0
Socket: FCC17-E09SB-**xx**0

.590" Footprint

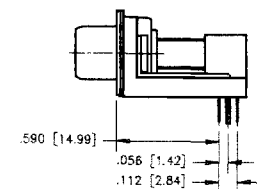

Pin: FCC17-E09PC-**xx**0
Socket: FCC17-E09SC-**xx**0

RIGHT ANGLE, WITH METAL MOUNTING BRACKETS

.318" Footprint

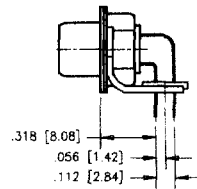

Pin: FCC17-E09PA-**xx**B
Socket: FCC17-E09SA-**xx**B

.405" Footprint

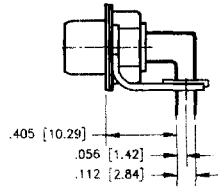

Pin: FCC17-E09PB-**xx**B
Socket: FCC17-E09SB-**xx**B

.590" Footprint

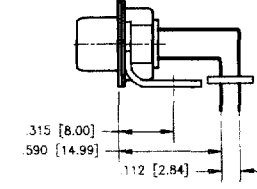

Pin: FCC17-E09PC-**xx**B
Socket: FCC17-E09SC-**xx**B

P.C.B. LAYOUT

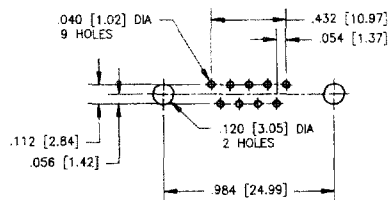

STANDARD P.C.B. LAYOUT

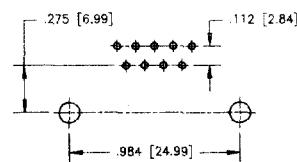

P.C.B. LAYOUT FOR
.590 METAL BRACKET ONLY

xx = To complete the P/N, see page 5 to assign Mounting Code and Filter Capacitance.
For electrical and mechanical specifications, see pages 2 and 3.

15 SIZE

FCC17

FILTERED D-SUB CONNECTORS

SOCKET

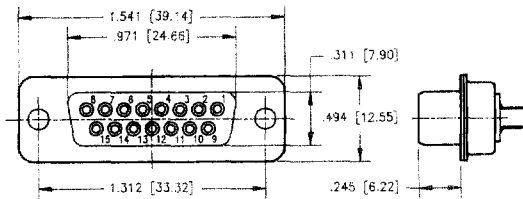

PIN

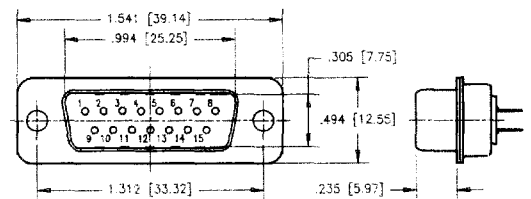

PIN-TO-SOCKET ADAPTER

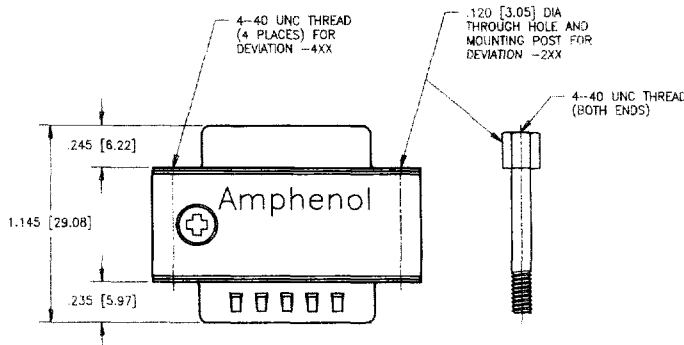

Mounting Options

4-40 Threaded Inserts:

FCC17-A15AD-4xx0

Through Hole with Mounting Post:

FCC17-A15AD-2xx0

SOLDER CUP TERMINATION

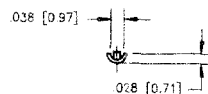
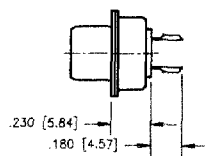

SOLDER CUP DETAIL
(ACCEPTS UP TO 20 AWG WIRE)

Pin: FCC17-A15PM-~~xxx~~0

Socket: FCC17-A15SM-~~xxx~~0

xxx = To complete the P/N, see page 5 to assign Mounting Code and Filter Capacitance.
For electrical and mechanical specifications, see pages 2 and 3.

15^{SIZE}

FCC17

FILTERED D SUB CONNECTORS

PC TAIL TERMINATION

VERTICAL MOUNT

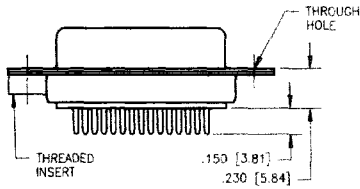

Pin: FCC17-A15PE-**xx**0
Socket: FCC17-A15SE-**xx**0

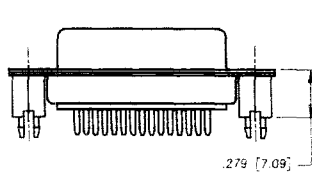

Pin: FCC17-A15PE-A**xx**0
Socket: FCC17-A15SE-A**xx**0

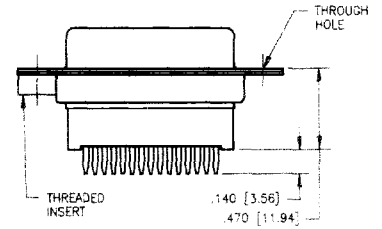

Pin: FCC17-A15PN-**xx**0
Socket: FCC17-A15SN-**xx**0

RIGHT ANGLE, WITH BOARDLOCKS

.318" Footprint

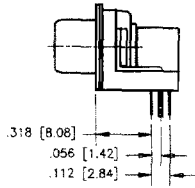

Pin: FCC17-A15PA-**xx**0
Socket: FCC17-A15SA-**xx**0

.405" Footprint

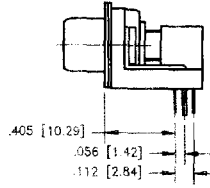

Pin: FCC17-A15PB-**xx**0
Socket: FCC17-A15SB-**xx**0

.590" Footprint

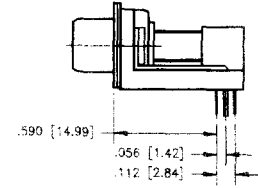

Pin: FCC17-A15PC-**xx**0
Socket: FCC17-A15SC-**xx**0

RIGHT ANGLE, WITH METAL MOUNTING BRACKETS

.318" Footprint

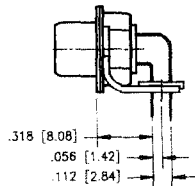

Pin: FCC17-A15PA-**xx**B
Socket: FCC17-A15SA-**xx**B

.405" Footprint

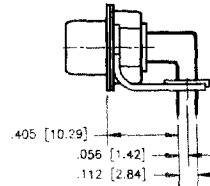

Pin: FCC17-A15PB-**xx**B
Socket: FCC17-A15SB-**xx**B

.590" Footprint

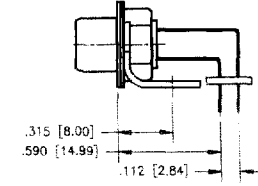

Pin: FCC17-A15PC-**xx**B
Socket: FCC17-A15SC-**xx**B

P.C.B. LAYOUT

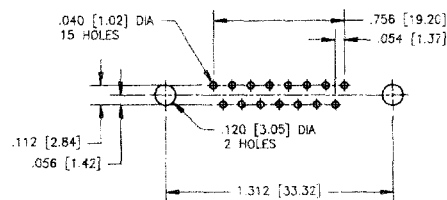

STANDARD P.C.B. LAYOUT

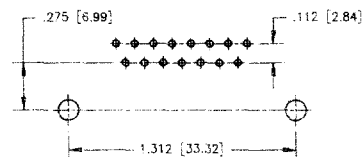

P.C.B. LAYOUT FOR
.590 METAL BRACKET ONLY

xx = To complete the P/N, see page 5 to assign Mounting Code and Filter Capacitance.
For electrical and mechanical specifications, see pages 2 and 3.

FCC17

25^{SIZE}

FILTERED D-SUB CONNECTORS

SOCKET

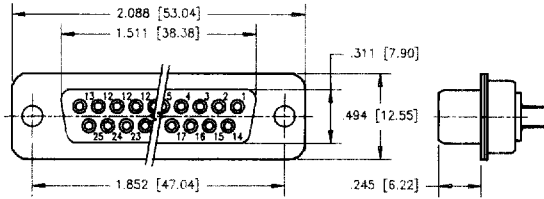

PIN

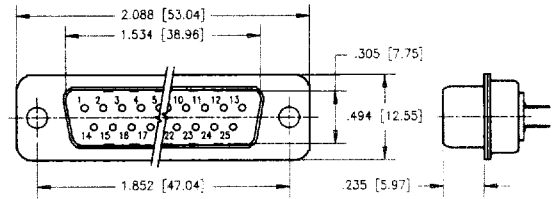

PIN-TO-SOCKET ADAPTER

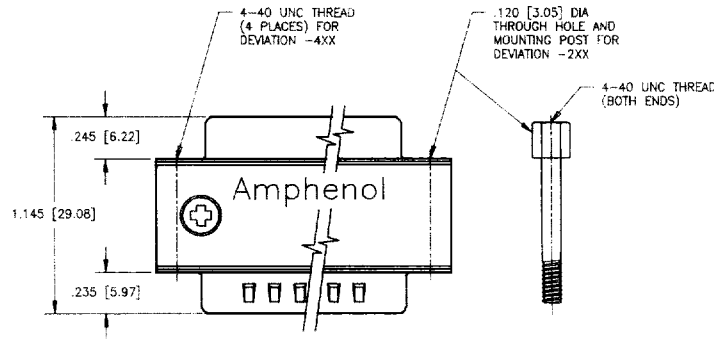

Mounting Options

4-40 Threaded Inserts:
Through Hole with Mounting Post:

FCC17-B25AD-4xx0
FCC17-B25AD-2xx0

SOLDER CUP TERMINATION

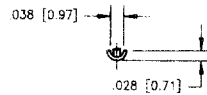
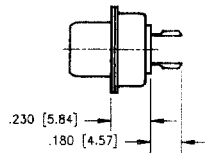

SOLDER CUP DETAIL
(ACCEPTS UP TO 20 AWG WIRE)

Pin: FCC17-B25PM-**xxx**0
Socket: FCC17-B25SM-**xxx**0

xxx = To complete the P/N, see page 5 to assign Mounting Code and Filter Capacitance.
For electrical and mechanical specifications, see pages 2 and 3.

FCC17

25 SIZE

FILTERED D-SUB CONNECTORS

PC TAIL TERMINATION

VERTICAL MOUNT

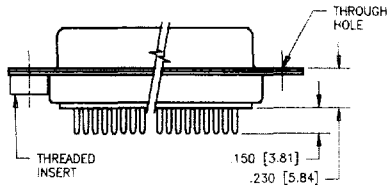

Pin: FCC17-B25PE-**xxx0**
Socket: FCC17-B25SE-**xxx0**

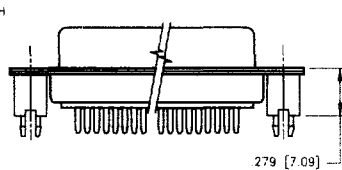

Pin: FCC17-B25PE-A**xxx0**
Socket: FCC17-B25SE-A**xxx0**

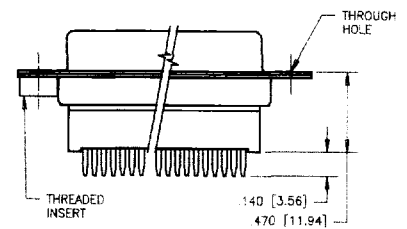

Pin: FCC17-B25PN-**xxx0**
Socket: FCC17-B25SN-**xxx0**

RIGHT ANGLE, WITH BOARDLOCKS

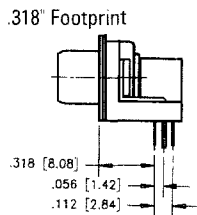

Pin: FCC17-B25PA-**xxx0**
Socket: FCC17-B25SA-**xxx0**

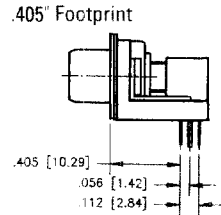

Pin: FCC17-B25PB-**xxx0**
Socket: FCC17-B25SB-**xxx0**

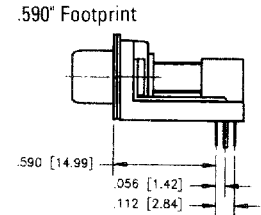

Pin: FCC17-B25PC-**xxx0**
Socket: FCC17-B25SC-**xxx0**

RIGHT ANGLE, WITH METAL MOUNTING BRACKETS

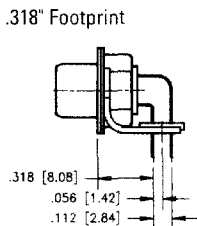

Pin: FCC17-B25PA-**xxxB**
Socket: FCC17-B25SA-**xxxB**

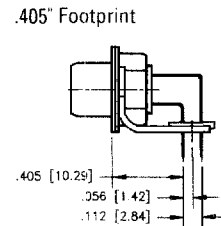

Pin: FCC17-B25PB-**xxxB**
Socket: FCC17-B25SB-**xxxB**

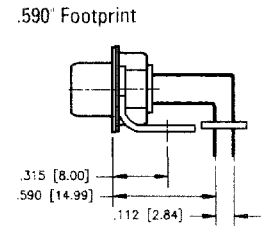

Pin: FCC17-B25PC-**xxxB**
Socket: FCC17-B25SC-**xxxB**

P.C.B. LAYOUT

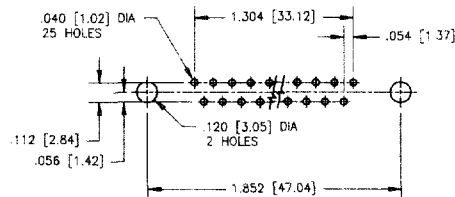

STANDARD P.C.B. LAYOUT

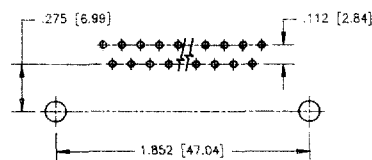

P.C.B. LAYOUT FOR
.590 METAL BRACKET ONLY

xxx = To complete the P/N, see page 5 to assign Mounting Code and Filter Capacitance.
For electrical and mechanical specifications, see pages 2 and 3.

FCC17

37 SIZE

FILTERED D-SUB CONNECTORS

SOCKET

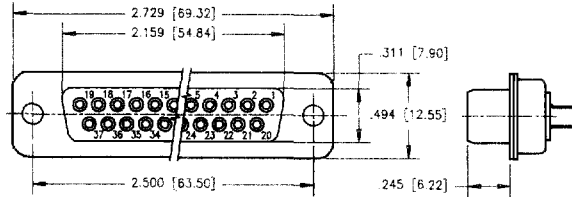

PIN

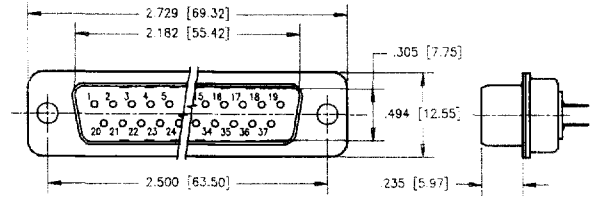

PIN-TO-SOCKET ADAPTER

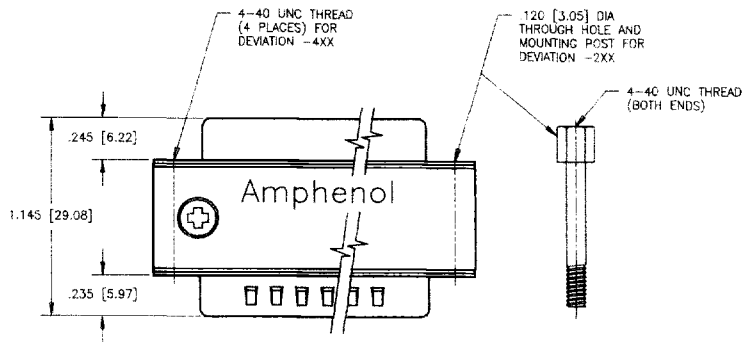

Mounting Options

4-40 Threaded Inserts:
Through Hole with Mounting Post:

FCC17-C37AD-4xx0
FCC17-C37AD-2xx0

SOLDER CUP TERMINATION

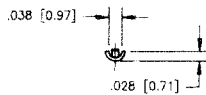
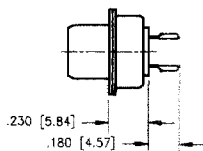

SOLDER CUP DETAIL
(ACCEPTS UP TO 20 AWG WIRE)

Pin: FCC17-C37PM-xx0
Socket: FCC17-C37SM-xx0

xx = To complete the P/N, see page 5 to assign Mounting Code and Filter Capacitance.
For electrical and mechanical specifications, see pages 2 and 3.

FCC 17

37^{SIZE}

FILTERED D-SUB CONNECTORS

PC TAIL TERMINATION

VERTICAL MOUNT

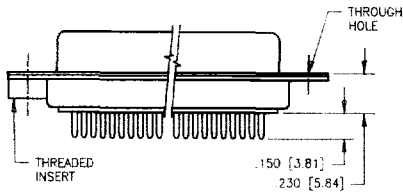

Pin: FCC17-C37PE-**XX**0
Socket: FCC17-C37SE-**XX**0

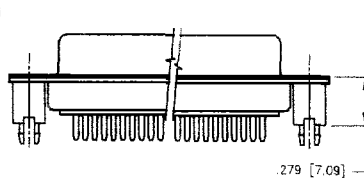

Pin: FCC17-C37PE-**A**XX0
Socket: FCC17-C37SE-**A**XX0

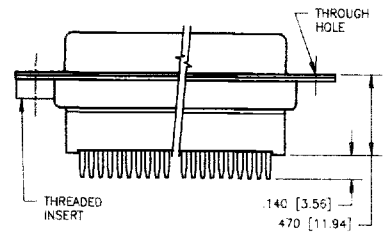

Pin: FCC17-C37PN-**XX**0
Socket: FCC17-C37SN-**XX**0

RIGHT ANGLE, WITH BOARDLOCKS

.318" Footprint

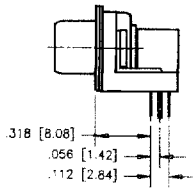

Pin: FCC17-C37PA-**XX**0
Socket: FCC17-C37SA-**XX**0

.405" Footprint

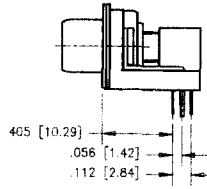

Pin: FCC17-C37PB-**XX**0
Socket: FCC17-C37SB-**XX**0

.590" Footprint

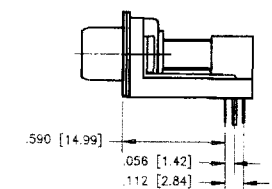

Pin: FCC17-C37PC-**XX**0
Socket: FCC17-C37SC-**XX**0

RIGHT ANGLE, WITH METAL MOUNTING BRACKETS

.318" Footprint

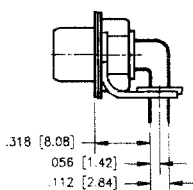

Pin: FCC17-C37PA-**XX**B
Socket: FCC17-C37SA-**XX**B

.405" Footprint

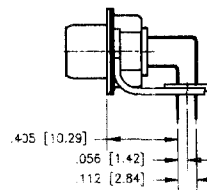

Pin: FCC17-C37PB-**XX**B
Socket: FCC17-C37SB-**XX**B

.590" Footprint

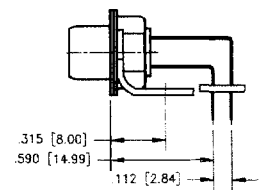

Pin: FCC17-C37PC-**XX**B
Socket: FCC17-C37SC-**XX**B

P.C.B. LAYOUT

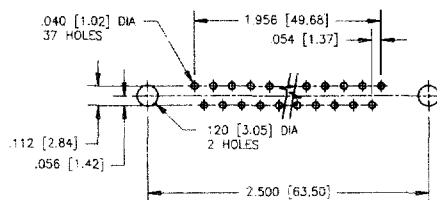

STANDARD P.C.B. LAYOUT

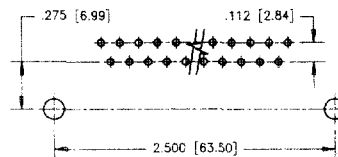

P.C.B. LAYOUT FOR
.590 METAL BRACKET ONLY

XX = To complete the P/N, see page 5 to assign Mounting Code and Filter Capacitance.
For electrical and mechanical specifications, see pages 2 and 3.