LOW NOISE 150mA WL-CSP LDO

NO.EA-107-0512

OUTLINE

The R115Z Series are CMOS-based voltage regulator ICs with extremely low supply current, low ON-resistance, and high ripple rejection. Each of these ICs consists of a voltage reference unit, an error amplifier, resistor-net for voltage setting, a current limit circuit, and a chip-enable circuit.

These ICs perform with low dropout voltage and a chip-enable function. The line transient response and load transient response of the R115Z Series are excellent, thus these ICs are very suitable for the power supply for hand-held communication equipment.

The output voltage of these ICs is fixed with high accuracy. Since the packages for these ICs is WL-CSP4-P4, therefore high density mounting of the ICs on boards is possible.

FEATURES

- Low Supply Current Typ. 75 μ A
- Standby Mode Typ. 0.1 μ A
- Low Dropout Voltage..... Typ. 0.22V ($I_{OUT}=150$ mA 3.0V Output type)
- High Ripple Rejection Typ. 70dB ($f=1$ kHz 3.0V Output type)
Typ. 60dB ($f=10$ kHz)
- Low Temperature-Drift Coefficient of Output Voltage..... Typ. ± 100 ppm/ $^{\circ}$ C
- Excellent Line Regulation Typ. 0.02%/V
- High Output Voltage Accuracy $\pm 2.0\%$
- Small Packages WL-CSP4-P4
- Output Voltage Stepwise setting with a step of 0.1V in the range of 1.5V to 4.0V is possible
- Built-in Fold Back Protection Circuit Typ. 40mA (Current at short mode)
- Ceramic capacitors are recommended to be used with this IC ... $C_{IN}=C_{OUT}=1\mu$ F ($V_{OUT}<2.5$ V)
 $C_{IN}=1\mu$ F, $C_{OUT}=0.47\mu$ F ($V_{OUT} \geq 2.5$ V)

APPLICATIONS

- Power source for portable communication equipment.
- Power source for electrical appliances such as cameras, VCRs and camcorders.
- Power source for battery-powered equipment.

BLOCK DIAGRAMS

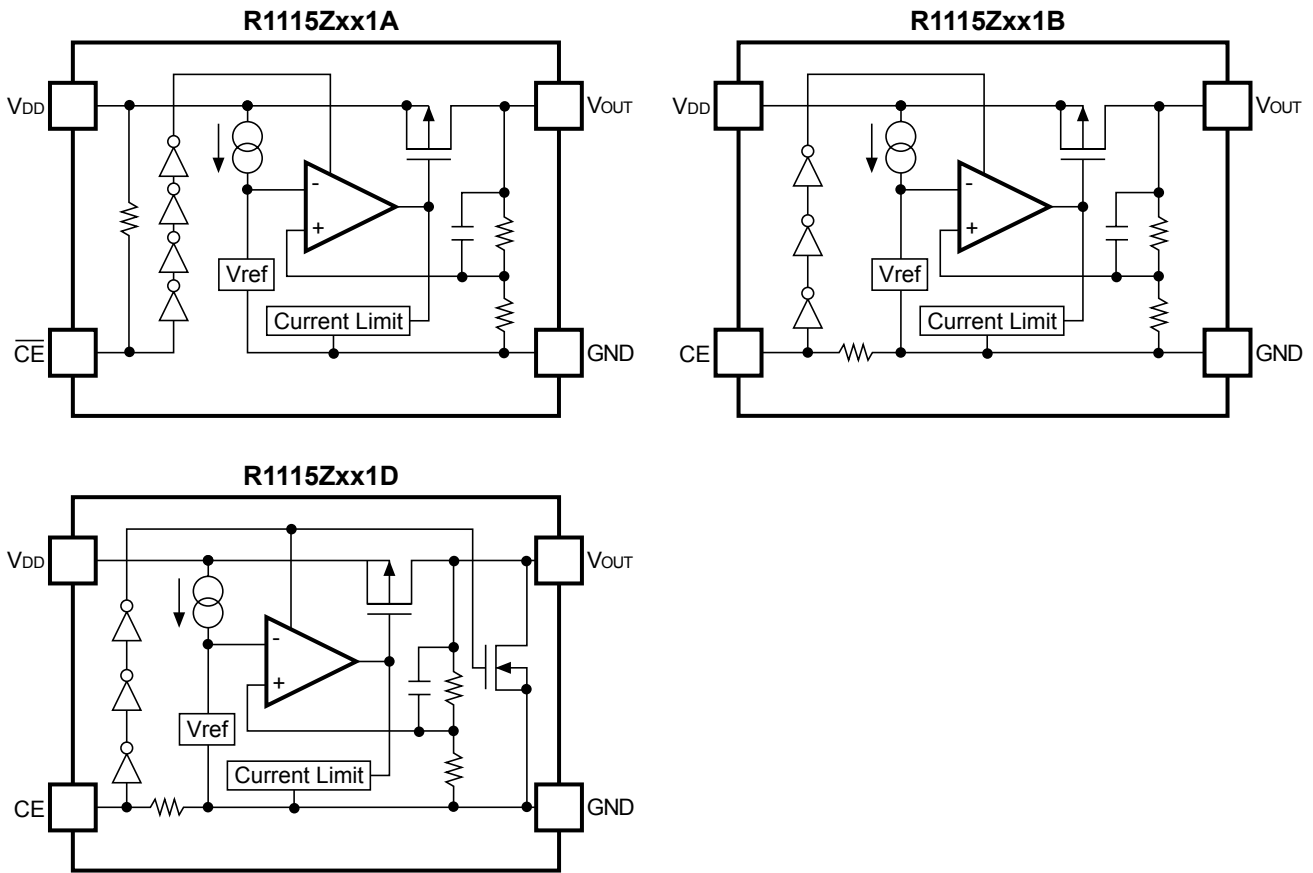

SELECTION GUIDE

The output voltage, version, and the taping type for the ICs can be selected at the user's request. The selection can be made with designating the part number as shown below;

R1115Z $\overset{\uparrow}{a}$ $\overset{\uparrow}{b}$ Z $\overset{\uparrow}{c}$ $\overset{\uparrow}{d}$ xx1x-xx ←Part Number

Code	Contents
a	Designation of Package Type: Z : WL-CSP4-P4
b	Setting Output Voltage (V _{OUT}): Stepwise setting with a step of 0.1V in the range of 1.5V to 4.0V is possible.
c	Designation of Active Type: A: active low type B: active high type D: active high, with auto discharge
d	Designation of Taping Type: Ex. TR (refer to Taping Specifications; TR type is the standard direction.)

PIN CONFIGURATION

- WL-CSP4-P4

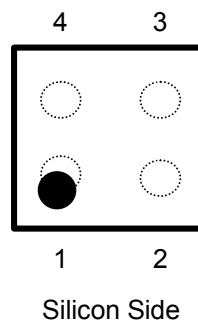
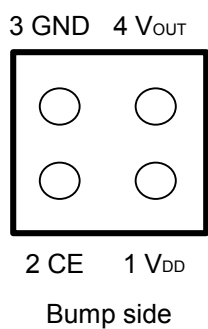

PIN DESCRIPTIONS

- R1115Z

Pin No.	Symbol	Description
1	V _{DD}	Input Pin
2	CE	Chip Enable Pin
3	GND	Ground Pin
4	V _{OUT}	Output pin

ABSOLUTE MAXIMUM RATINGS

Symbol	Item	Rating	Unit
V _{IN}	Input Voltage	6.5	V
V _{CE}	Input Voltage ($\overline{\text{CE}}$ or CE Pin)	6.5	V
V _{OUT}	Output Voltage	-0.3~V _{IN} +0.3	V
I _{OUT}	Output Current	200	mA
P _D	Power Dissipation	*Note	mW
T _{opt}	Operating Temperature Range	-40~85	°C
T _{stg}	Storage Temperature Range	-55~125	°C

*Note :This specification is at mounted on board.

Power Dissipation

*Measurement Conditions

Test Conditions: Mounted on PCB (Wind velocity 0m/s)

Board Material: FR-4 (Double layer)

Board dimensions : 40mm× 40mm×1.6mm

Metal Ratio :50%

*Result

$P_D=600\text{mW}$, Thermal Resistance 167°C/W

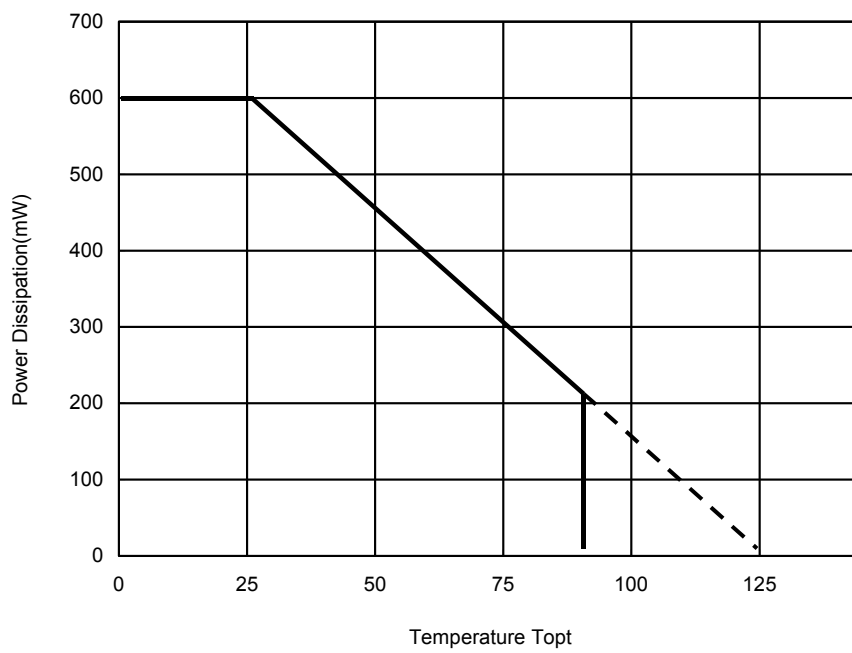

ELECTRICAL CHARACTERISTICS

• R1115Zxx1A

 $T_{opt}=25^{\circ}\text{C}$

Symbol	Item	Conditions	Min.	Typ.	Max.	Unit
V_{OUT}	Output Voltage	$V_{IN} = \text{Set } V_{OUT}+1\text{V}$ $1\text{mA} \leq I_{OUT} \leq 30\text{mA}$	$\times 0.980$		$\times 1.020$	V
I_{OUT}	Output Current	$V_{IN}-V_{OUT} = 1.0\text{V}$	150			mA
$\Delta V_{OUT}/\Delta I_{OUT}$	Load Regulation	$V_{IN} = \text{Set } V_{OUT}+1\text{V}$ $1\text{mA} \leq I_{OUT} \leq 150\text{mA}$		22	40	mV
V_{DIF}	Dropout Voltage	Refer to the ELECTRICAL CHARACTERISTICS by OUTPUT VOLTAGE				
I_{SS}	Supply Current	$V_{IN} = \text{Set } V_{OUT}+1\text{V}, I_{OUT} = 0\text{mA}$		75	95	μA
$I_{standby}$	Supply Current (Standby)	$V_{IN} = \text{Set } V_{OUT}+1\text{V}$ $V_{CE} = V_{DD}$		0.1	1.0	μA
$\Delta V_{OUT}/\Delta V_{IN}$	Line Regulation	$V_{OUT} > 1.7\text{V}$, Set $V_{OUT}+0.5\text{V} \leq V_{IN} \leq 6.0\text{V}$ ($V_{OUT} \leq 1.7\text{V}, 2.2\text{V} \leq V_{IN} \leq 6.0\text{V}$) $I_{OUT} = 30\text{mA}$		0.02	0.10	%/V
RR	Ripple Rejection	$f=1\text{kHz}$ $f=10\text{kHz}$ Ripple 0.5Vp-p $V_{OUT} > 1.7\text{V}, V_{IN}-V_{OUT} = 1.0\text{V}$ $V_{OUT} \leq 1.7, V_{IN}-V_{OUT} = 1.2\text{V}$ $I_{OUT} = 30\text{mA}$		70 60		dB
V_{IN}	Input Voltage		2.0		6.0	V
$\Delta V_{OUT}/\Delta T_{opt}$	Output Voltage Temperature Coefficient	$I_{OUT} = 30\text{mA}$ $-40^{\circ}\text{C} \leq T_{opt} \leq 85^{\circ}\text{C}$		± 100		ppm/ $^{\circ}\text{C}$
I_{limit}	Short Current Limit	$V_{OUT} = 0\text{V}$		40		mA
R_{PU}	CE Pull-up Resistance		0.7	2.0	8.0	$\text{M}\Omega$
V_{CEH}	CE Input Voltage "H"		1.5		6.0	V
V_{CEL}	CE Input Voltage "L"		0.0		0.3	V
en	Output Noise	BW = 10Hz to 100kHz		30		μV_{rms}

R1115Z

• R1115Zxx1B/D

T_{opt}=25°C

Symbol	Item	Conditions	Min.	Typ.	Max.	Unit
V _{OUT}	Output Voltage	V _{IN} = Set V _{OUT} +1V 1mA ≤ I _{OUT} ≤ 30mA	×0.980		×1.020	V
I _{OUT}	Output Current	V _{IN} -V _{OUT} = 1.0V	150			mA
ΔV _{OUT} /ΔI _{OUT}	Load Regulation	V _{IN} = Set V _{OUT} +1V 1mA ≤ I _{OUT} ≤ 150mA		22	40	mV
V _{DIF}	Dropout Voltage	Refer to the ELECTRICAL CHARACTERISTICS by OUTPUT VOLTAGE				
I _{SS}	Supply Current	V _{IN} = Set V _{OUT} +1V, I _{OUT} = 0mA		75	95	μA
I _{standby}	Supply Current (Standby)	V _{IN} = Set V _{OUT} +1V V _{CE} = GND		0.1	1.0	μA
ΔV _{OUT} /ΔV _{IN}	Line Regulation	V _{OUT} > 1.7V, Set V _{OUT} +0.5V ≤ V _{IN} ≤ 6.0V (V _{OUT} ≤ 1.7V, 2.2V ≤ V _{IN} ≤ 6.0V) I _{OUT} = 30mA		0.02	0.10	%/V
RR	Ripple Rejection	f=1kHz f=10kHz Ripple 0.5Vp-p V _{OUT} > 1.7V, V _{IN} -V _{OUT} = 1.0V V _{OUT} ≤ 1.7, V _{IN} -V _{OUT} = 1.2V I _{OUT} = 30mA		70 60		dB
V _{IN}	Input Voltage		2.0		6.0	V
ΔV _{OUT} /ΔT _{opt}	Output Voltage Temperature Coefficient	I _{OUT} = 30mA -40°C ≤ T _{opt} ≤ 85°C		±100		ppm/°C
I _{limit}	Short Current Limit	V _{OUT} = 0V		40		mA
R _{PD}	CE Pull-down Resistance		0.7	2.0	8.0	MΩ
V _{CEH}	CE Input Voltage "H"		1.5		6.0	V
V _{CEL}	CE Input Voltage "L"		0.0		0.3	V
en	Output Noise	BW = 10Hz to 100kHz		30		μVrms
R _{LOW}	On Resistance of Nch for auto-discharge (Only for D version)	V _{CE} = 0V		60		Ω

• ELECTRICAL CHARACTERISTICS by OUTPUT VOLTAGE

T_{opt} = 25°C

Output Voltage V _{OUT} (V)	Dropout Voltage V _{DIF} (V)		
	Condition	Typ.	Max.
V _{OUT} = 1.5	I _{OUT} =150mA	0.38	0.70
V _{OUT} = 1.6		0.36	0.65
V _{OUT} = 1.7		0.34	0.60
1.8 ≤ V _{OUT} ≤ 2.0		0.32	0.55
2.1 ≤ V _{OUT} ≤ 2.7		0.28	0.50
2.8 ≤ V _{OUT} ≤ 4.0		0.22	0.35

TECHNICAL NOTES

When using these ICs, consider the following points:

Phase Compensation

In these ICs, phase compensation is made for securing stable operation even if the load current is varied. For this purpose, use a capacitor C_{OUT} with good frequency characteristics and ESR (Equivalent Series Resistance). (Note: If additional ceramic capacitors are connected with parallel to the output pin with an output capacitor for phase compensation, the operation might be unstable. Because of this, test these ICs with as same external components as ones to be used on the PCB.)

PCB Layout

Make V_{DD} and GND lines sufficient. If their impedance is high, noise pickup or unstable operation may result. Connect a capacitor with a capacitance value as much as 1.0μF or more between V_{DD} and GND pin, and as close as possible to the pins.

Set external components, especially the output capacitor, as close as possible to the ICs, and make wiring as short as possible.

TEST CIRCUITS

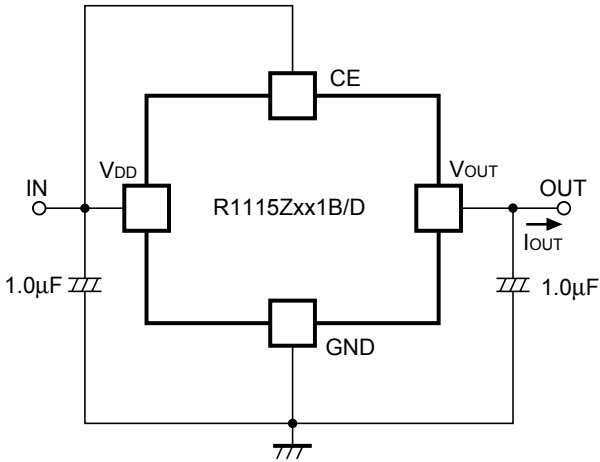

Fig.1 Standard test Circuit

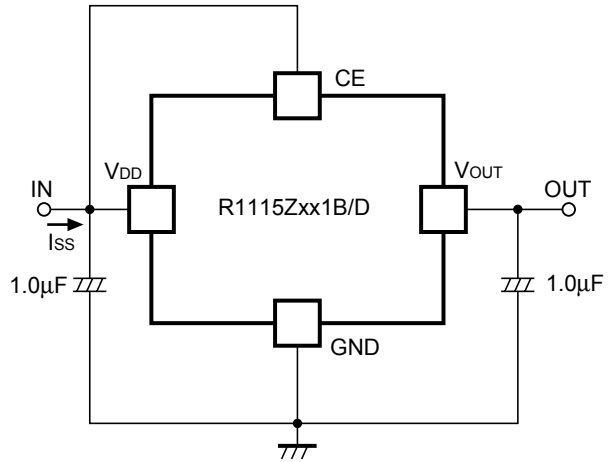

Fig.2 Supply Current Test Circuit

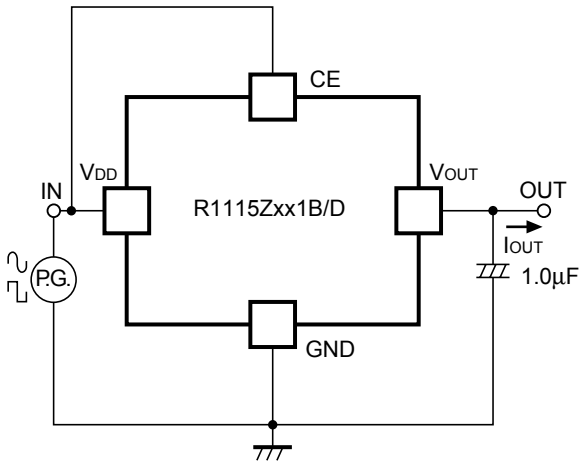

Fig.3 Ripple Rejection, Line Transient Response Test Circuit

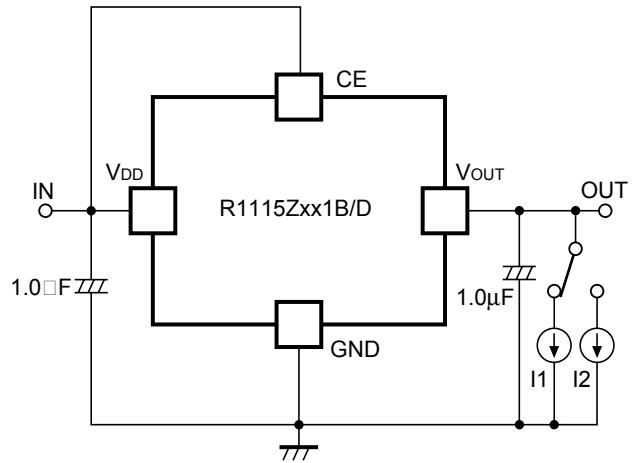
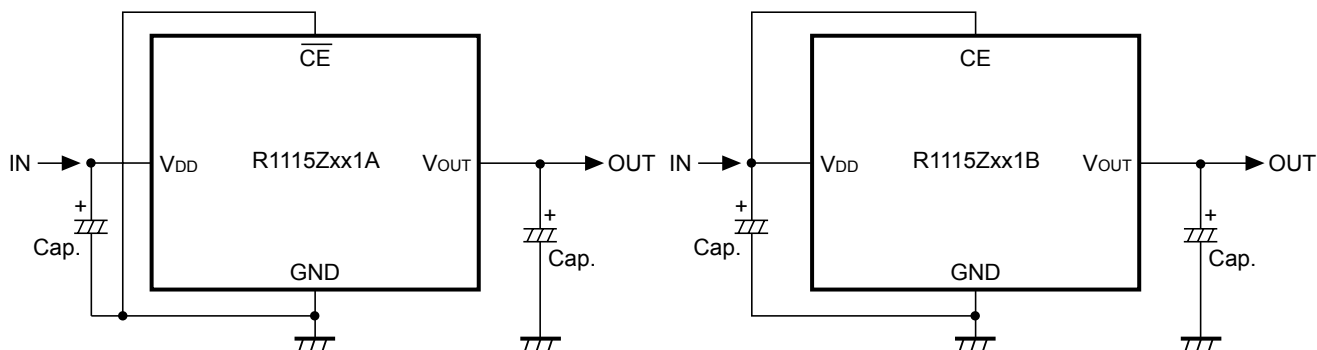

Fig.4 Load Transient Response Test Circuit

TYPICAL APPLICATIONS



(External Components)

Output Capacitor; Ceramic $0.47\mu\text{F}$ (Set Output Voltage in the range from 2.5 to 4.0V)

Ceramic $1.0\mu\text{F}$ (Set Output Voltage in the range from 1.5 to 2.4V)

Input Capacitor; Ceramic $1.0\mu\text{F}$

TYPICAL CHARACTERISTICS

1) Output Voltage vs. Output Current ($T_{\text{opt}}=25^{\circ}\text{C}$)

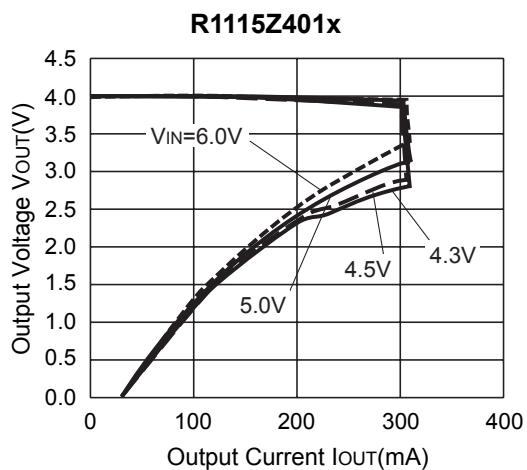
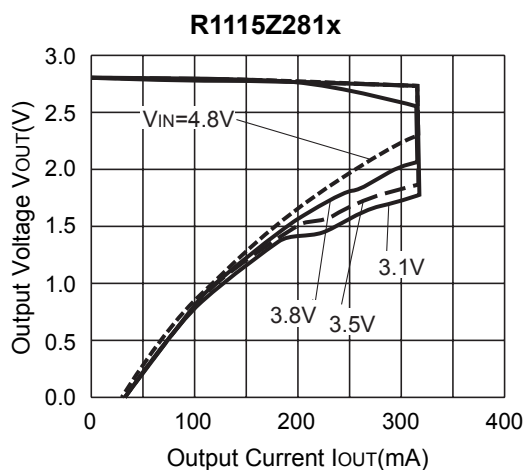
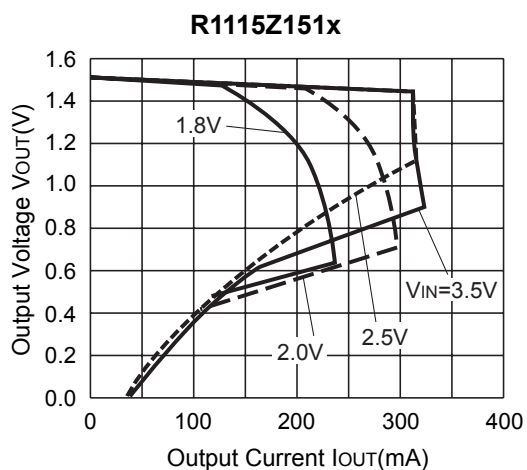

2) Output Voltage vs. Input Voltage (T_{opt}=25°C)

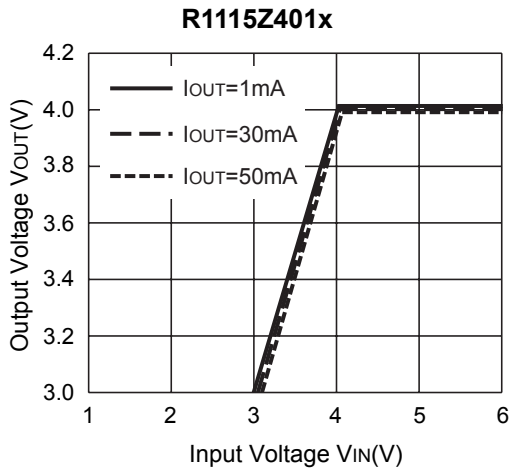
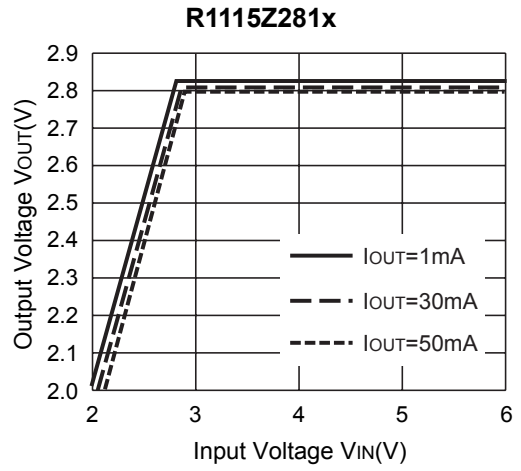
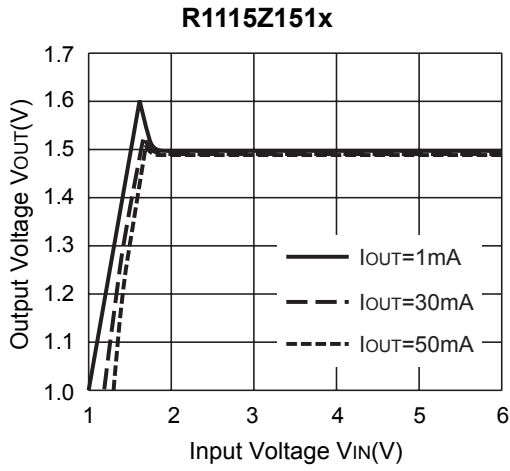

3) Supply Current vs. Input Voltage (T_{opt}=25°C)

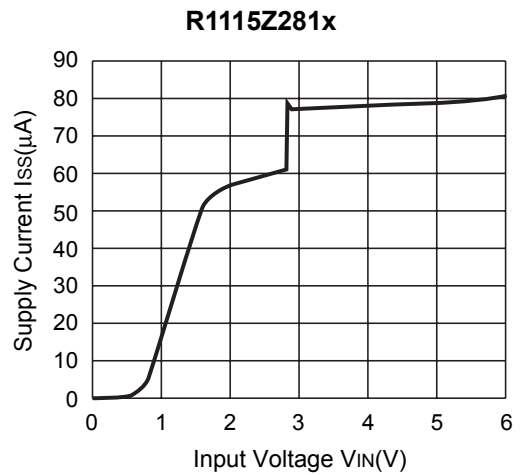
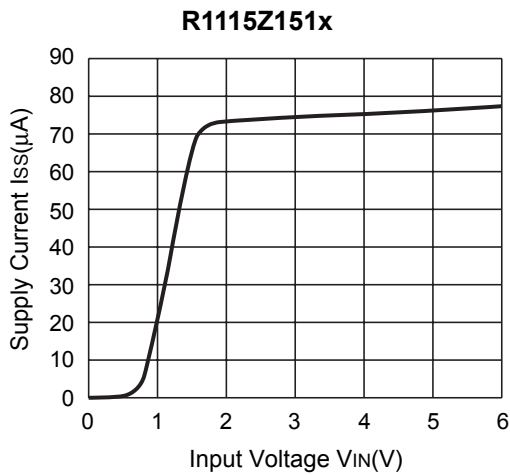

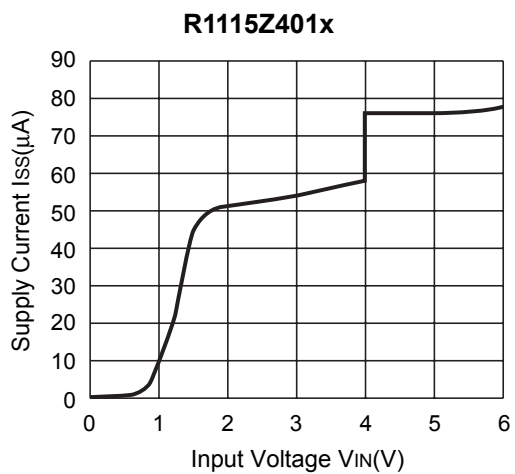

4) Output Voltage vs. Temperature

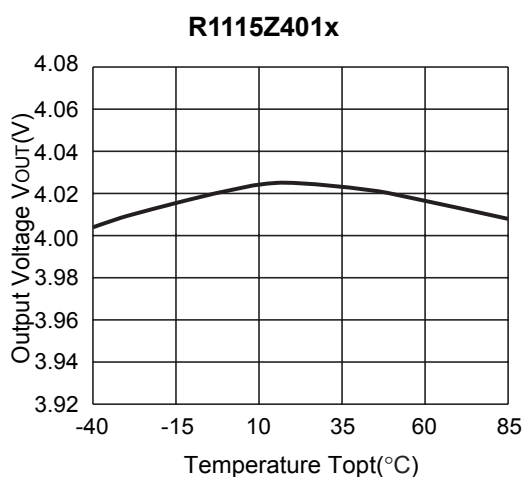
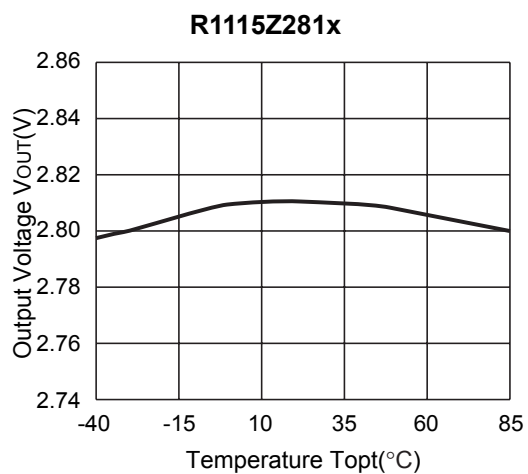
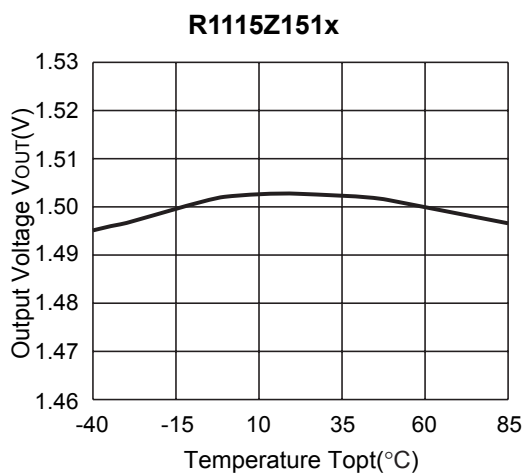

5) Supply Current vs. Temperature

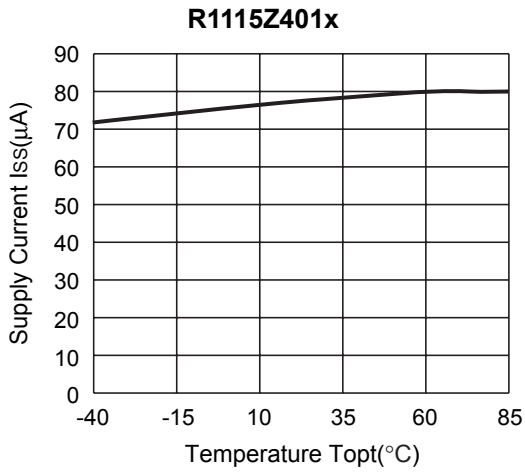
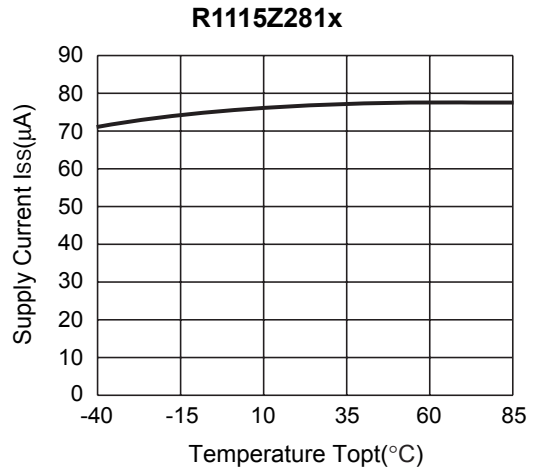
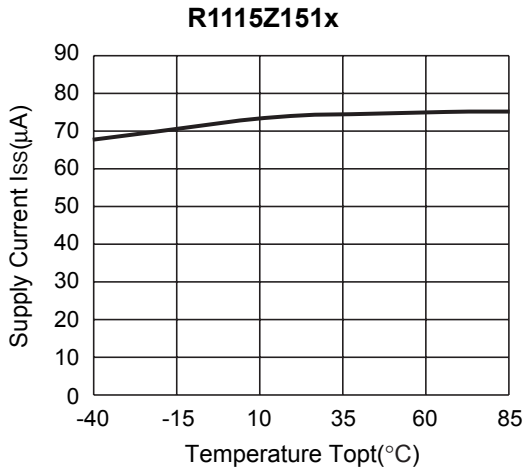

6) Dropout Voltage vs. Temperature

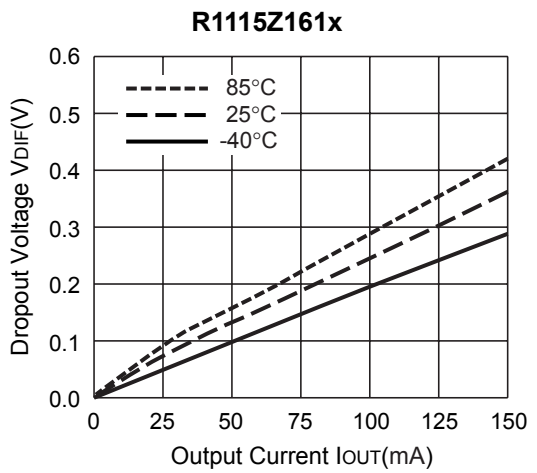
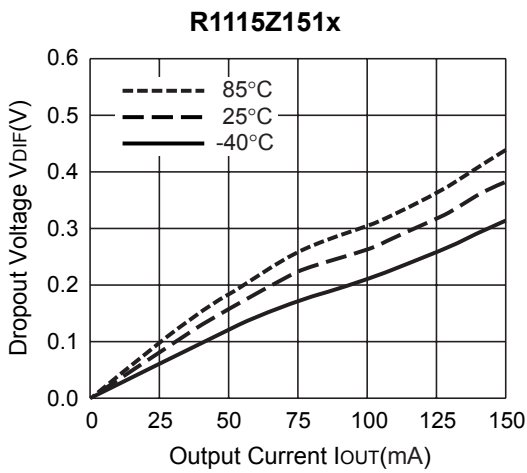

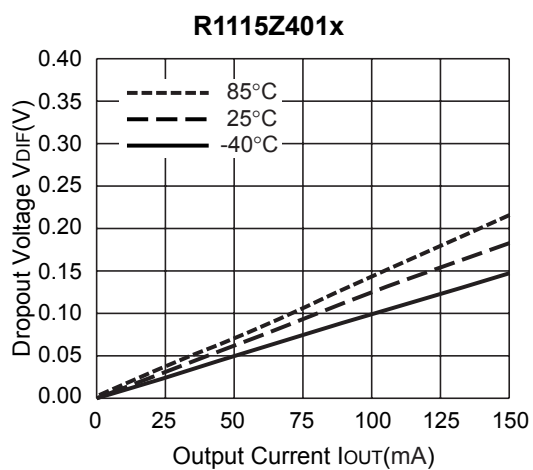
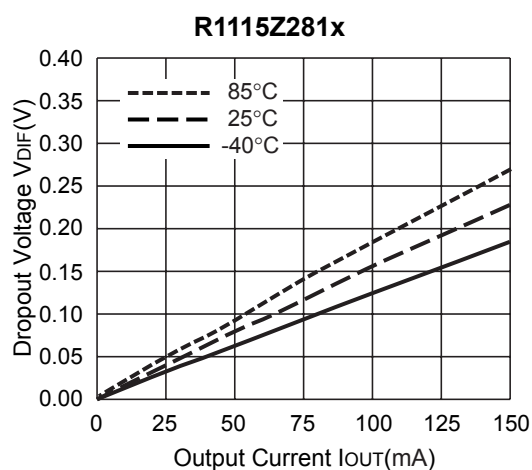
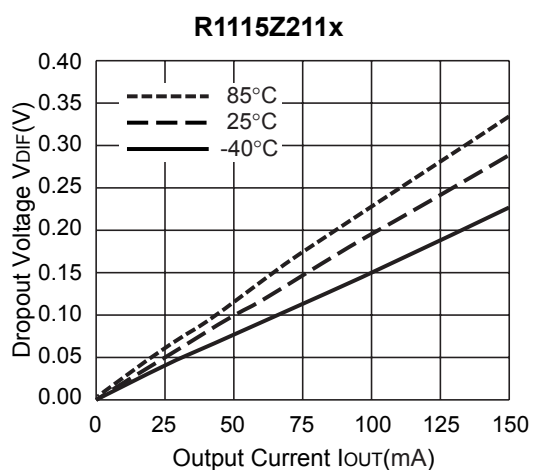
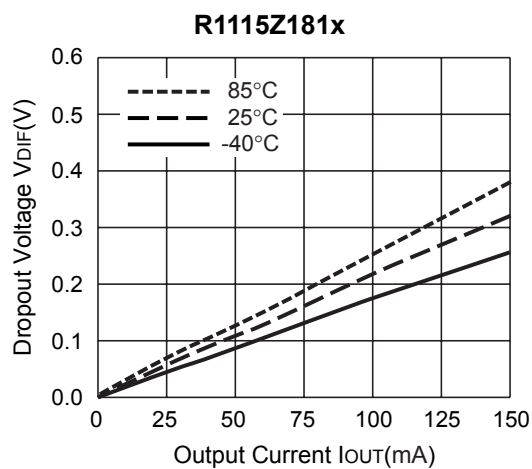
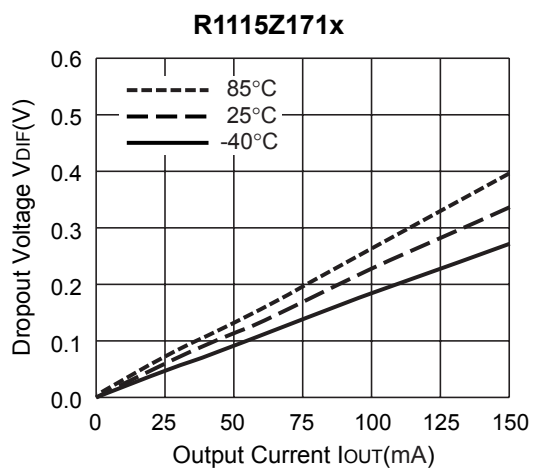

7) Dropout Voltage vs. Set Output Voltage ($T_{opt}=25^{\circ}C$)

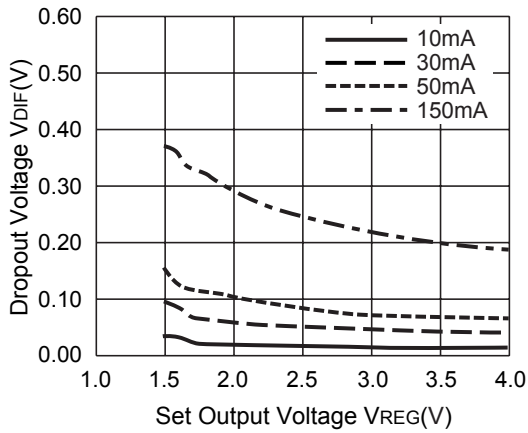

8) Ripple Rejection vs. Input Bias Voltage ($T_{opt}=25^{\circ}C$, C_{IN} =none, C_{OUT} =ceramic0.47 μ F)

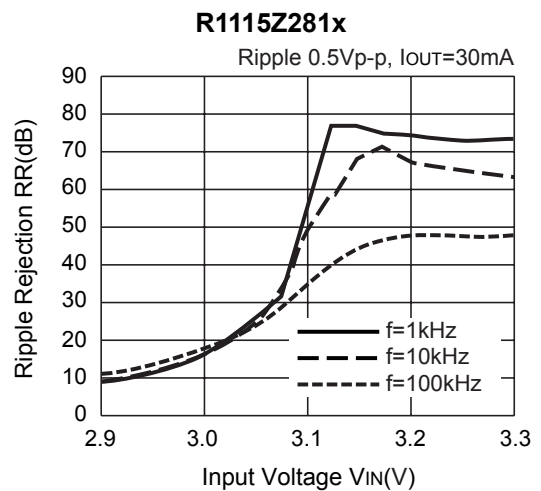
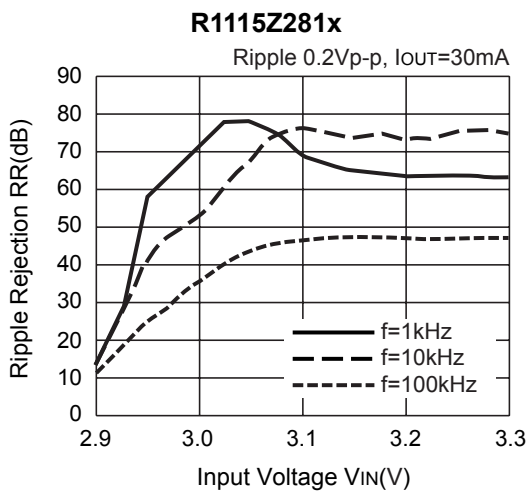
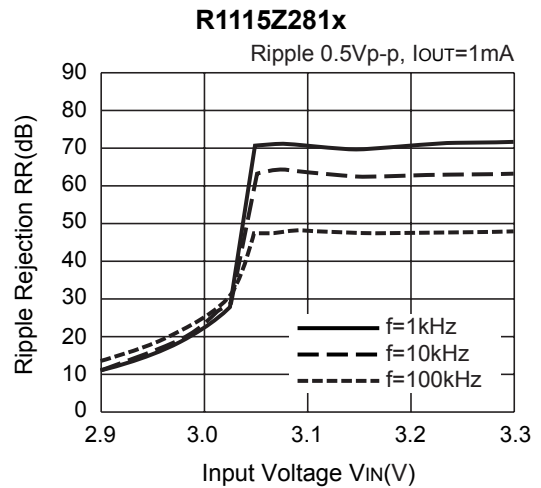
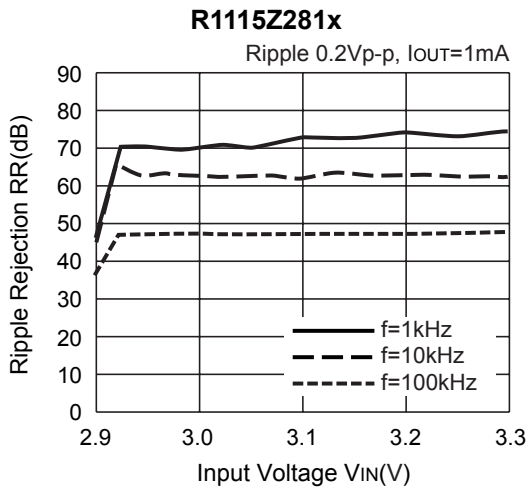

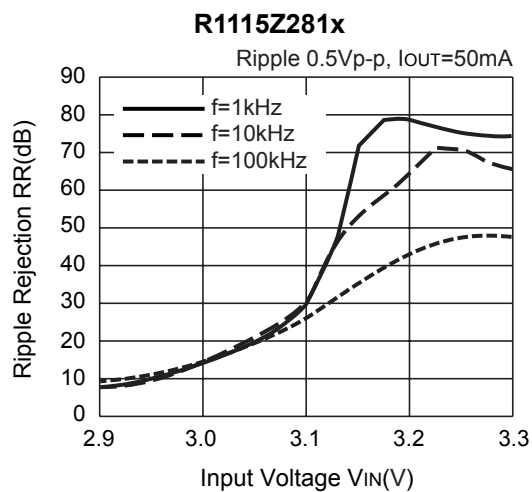
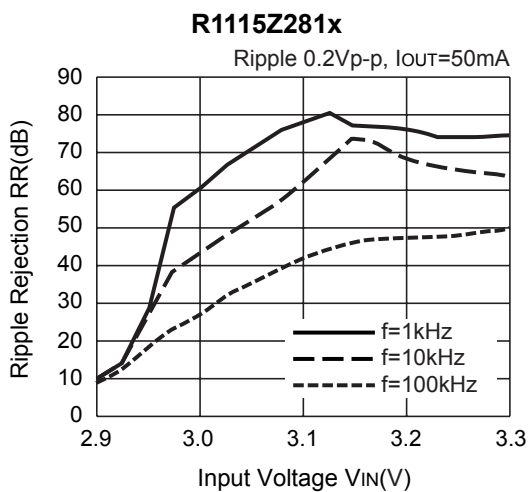

9) Ripple Rejection vs. Frequency (C_{IN} =none)

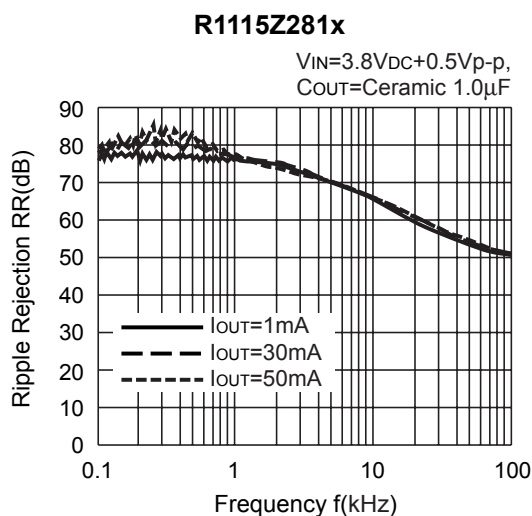
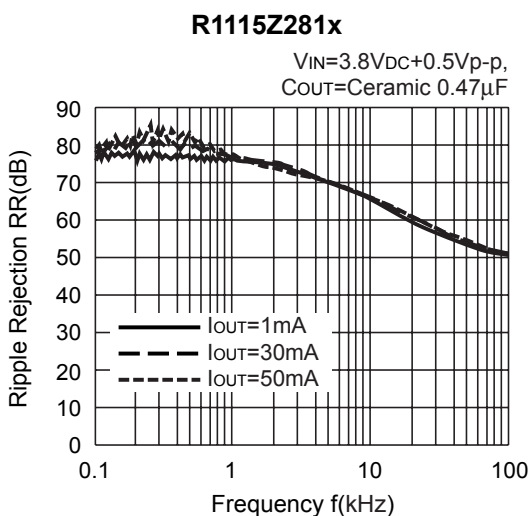
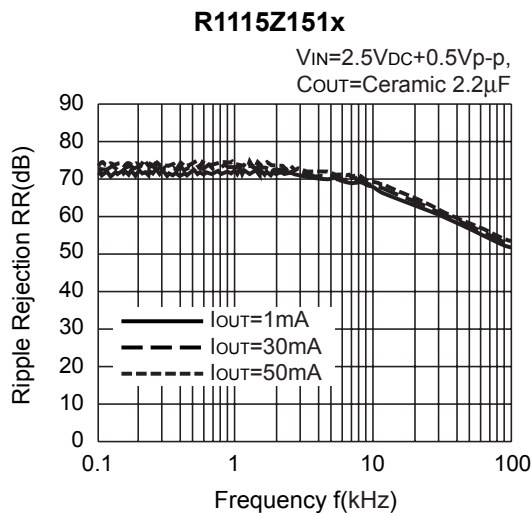
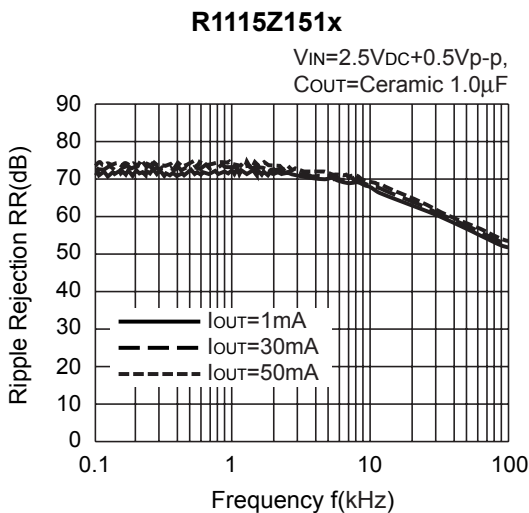

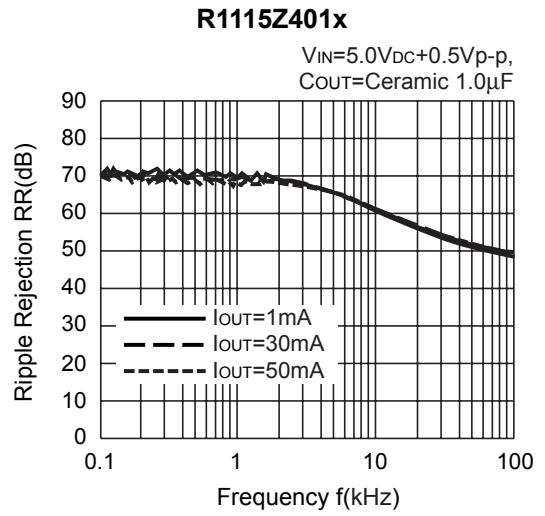
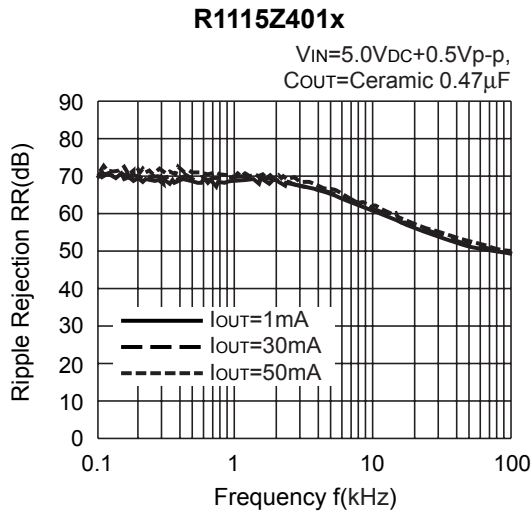

10) Input Transient Response ($I_{OUT}=30mA$, $C_{IN}=\text{none}$, $t_r=t_f=5\mu s$, $C_{OUT}=\text{Ceramic } 0.47\mu F$)

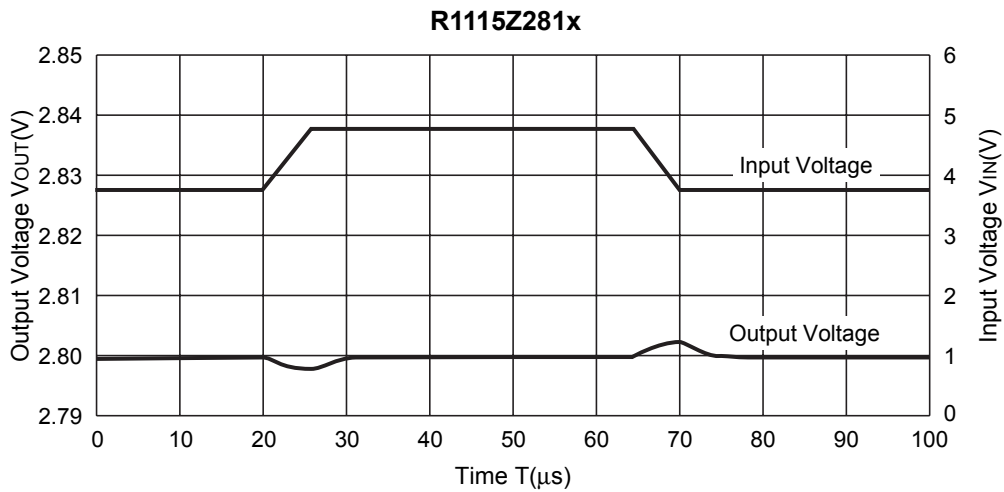
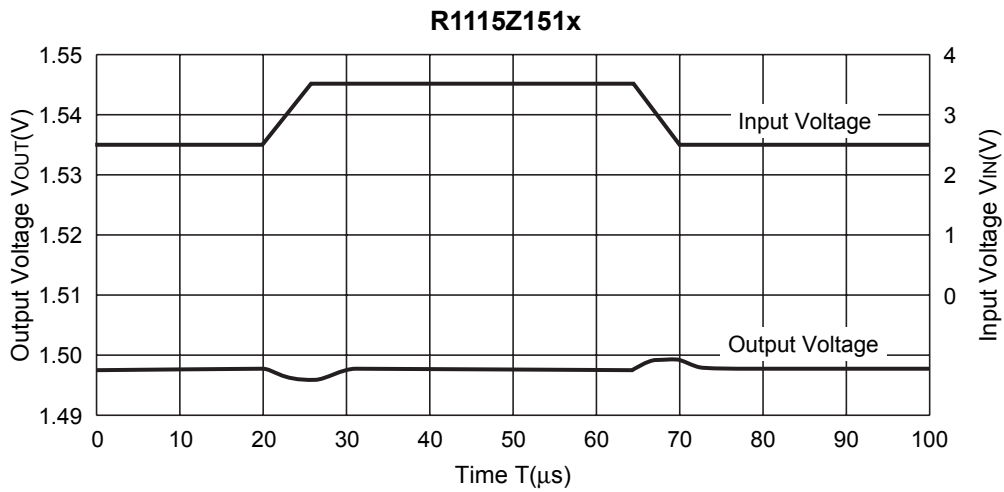

11) Load Transient Response ($t_r=t_f=0.5\mu s$, C_{IN} =Ceramic $1.0\mu F$)

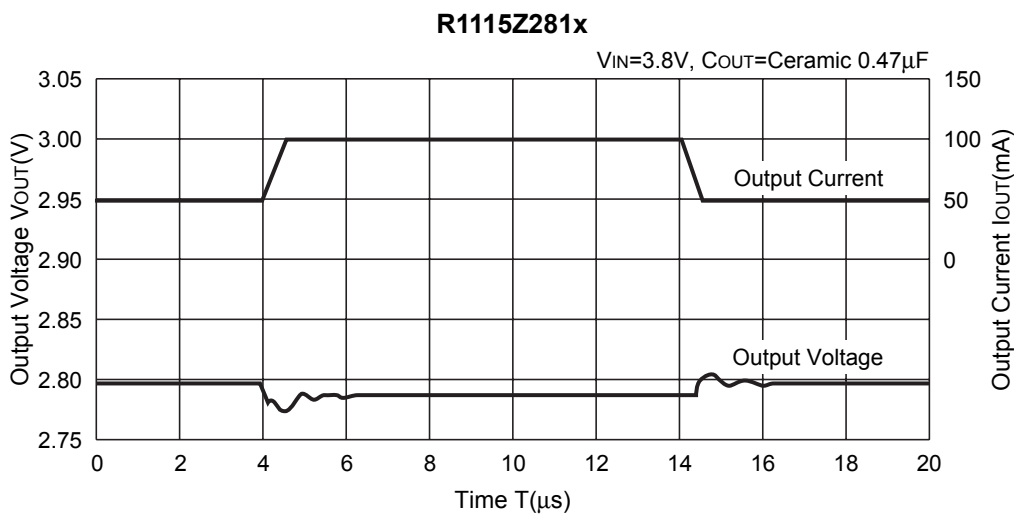
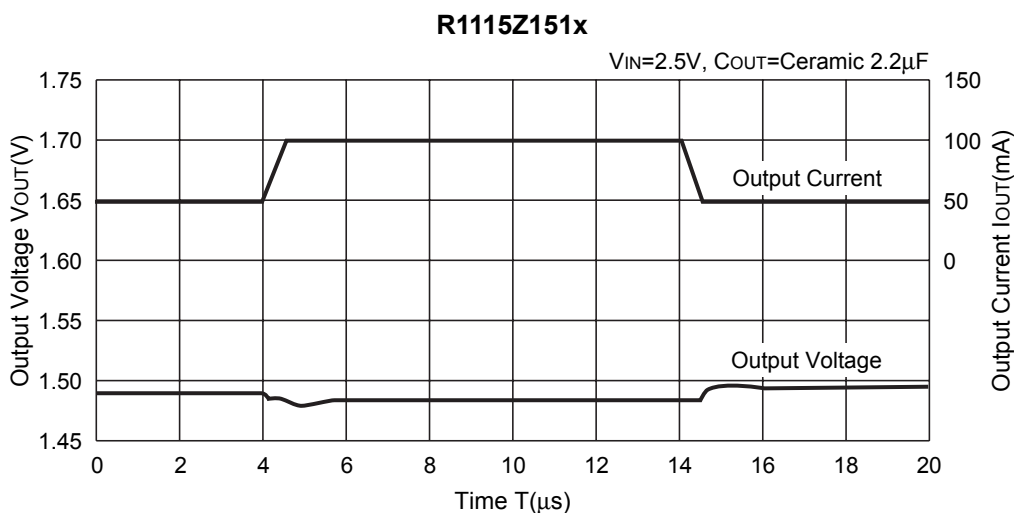
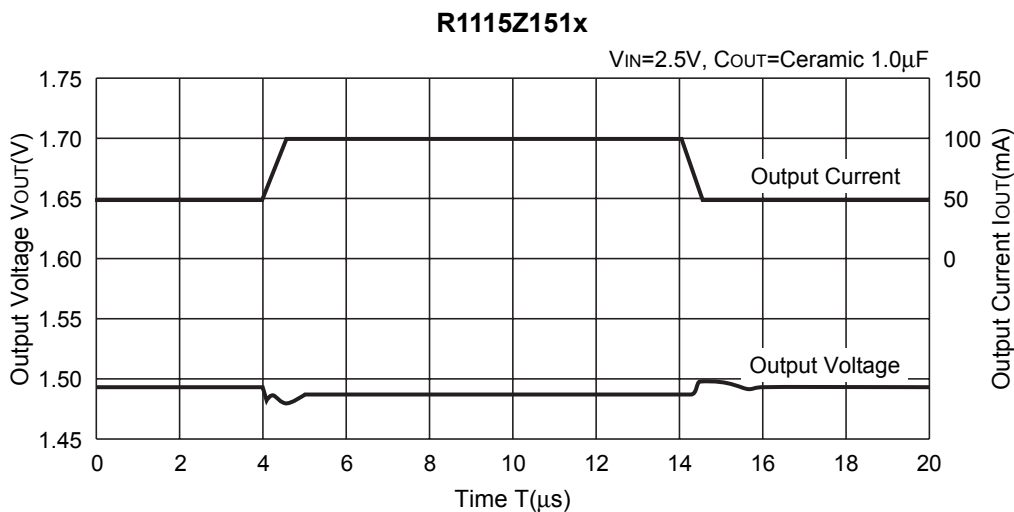

R1115Z281x

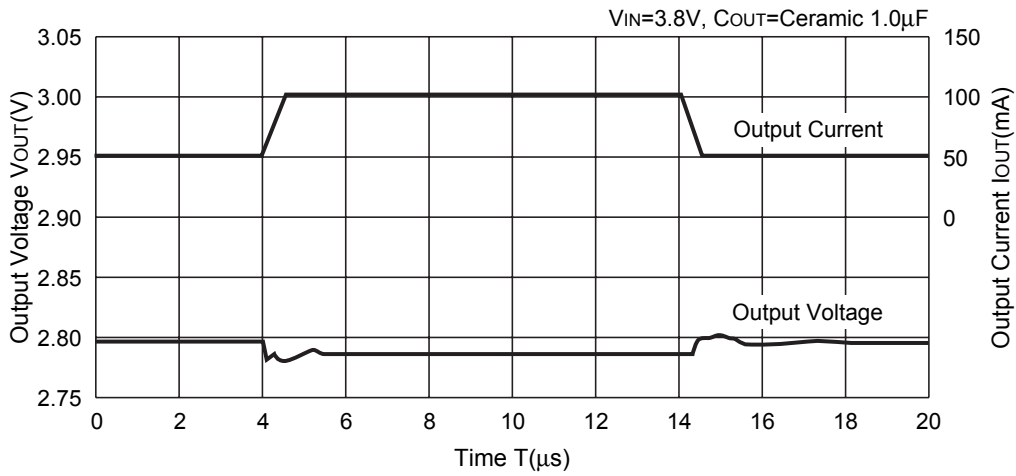

R1115Z281x

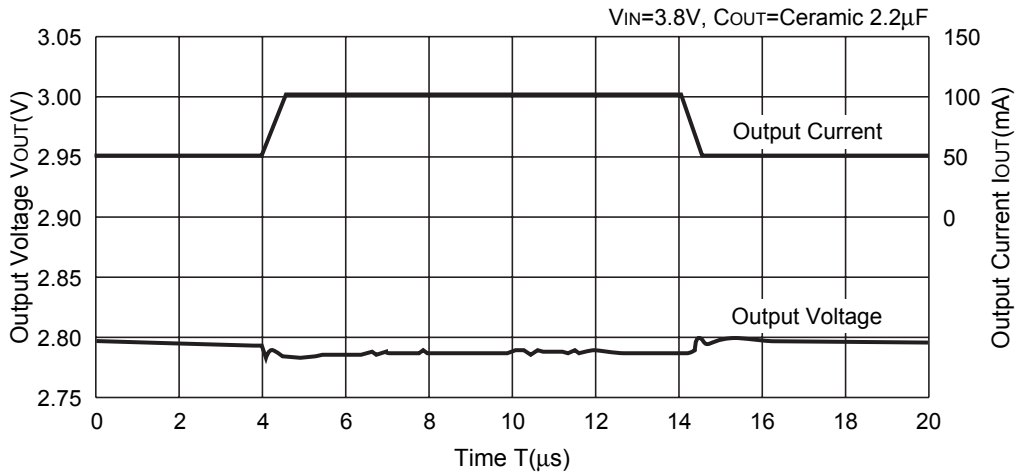

12) Turn-on/off speed with CE pin (D version)

R1115Z151D ($V_{IN}=2.5V$, $C_{IN}=\text{Ceramic } 1.0\mu F$, $C_{OUT}=\text{Ceramic } 1.0\mu F$)

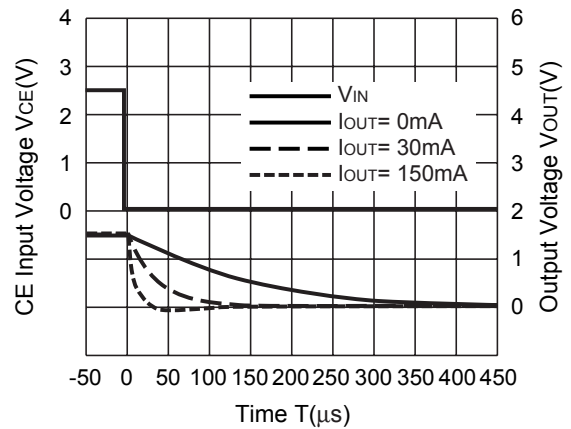
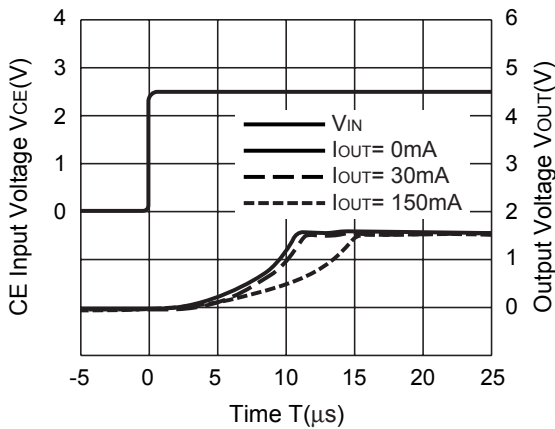

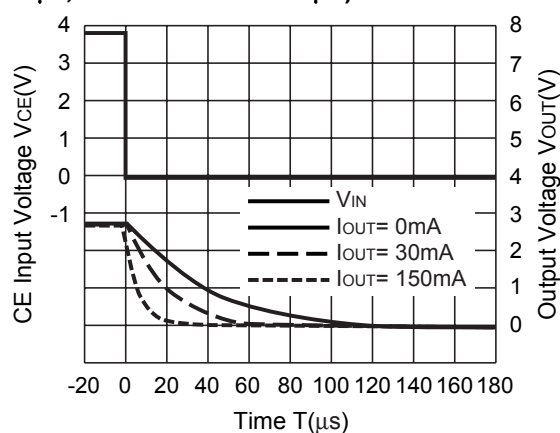
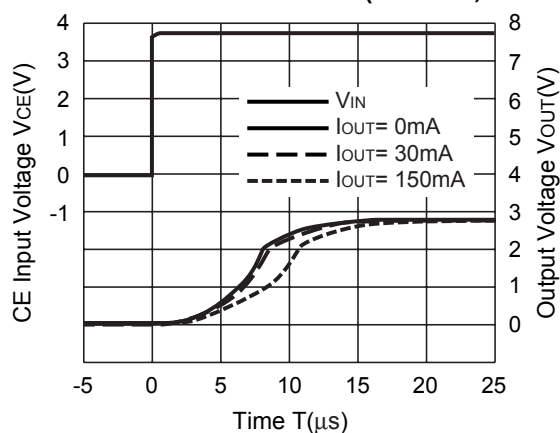
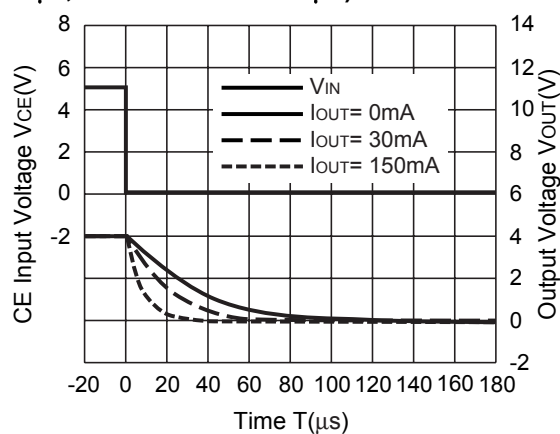
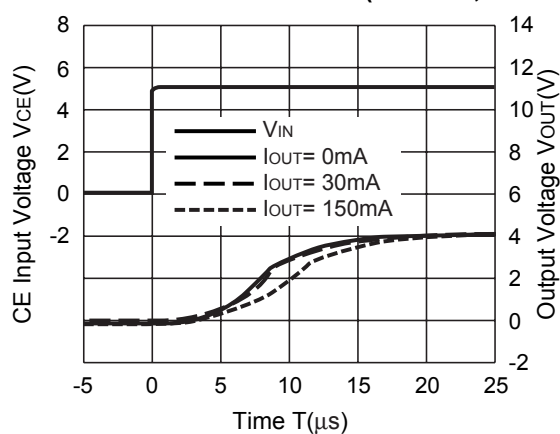
R1115Z281D ($V_{IN}=3.8V$, $C_{IN}=\text{Ceramic } 0.47\mu F$, $C_{OUT}=\text{Ceramic } 0.47\mu F$)R1115Z401D ($V_{IN}=5.0V$, $C_{IN}=\text{Ceramic } 0.47\mu F$, $C_{OUT}=\text{Ceramic } 0.47\mu F$)

ESR vs. Output Current

When using these ICs, consider the following points:

In these ICs, phase compensation is made for securing stable operation even if the load current is varied. For this purpose, use a capacitor C_{OUT} with good frequency characteristics and ESR (Equivalent Series Resistance) of which is in the range described as follows:

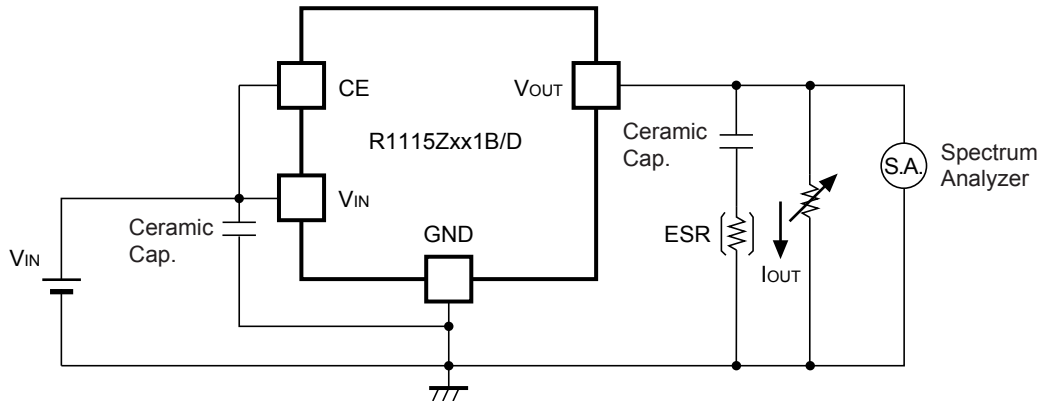

Measuring Circuit for white noise; R1115Zxx1B/D

The relations between I_{OUT} (Output Current) and ESR of an output capacitor are shown below. The conditions when the white noise level is under $40\mu V$ (Avg.) are marked as the hatched area in the graph.

(Note: If additional ceramic capacitors are connected to the Output Pin with Output capacitor for phase compensation, the operation might be unstable. Because of this, test these ICs with as same external components as ones to be used on the PCB.)

<Measurement conditions>

- (1) $V_{IN} = V_{OUT} + 1V$
- (2) Frequency Band: 10Hz to 2MHz
- (3) Temperature: $-40^{\circ}C$ to $25^{\circ}C$

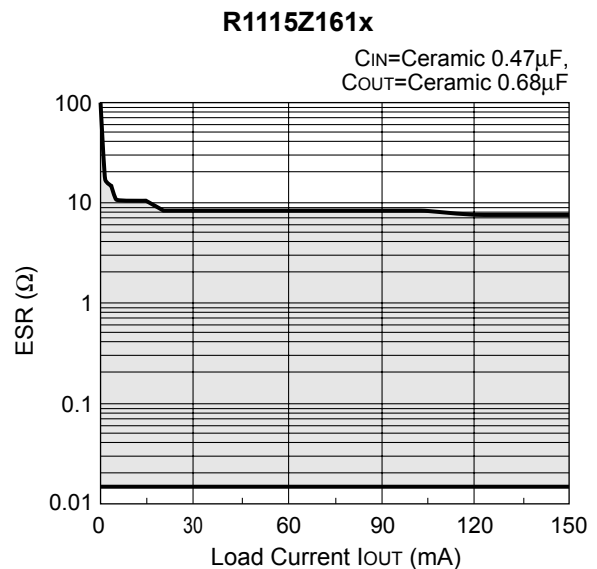
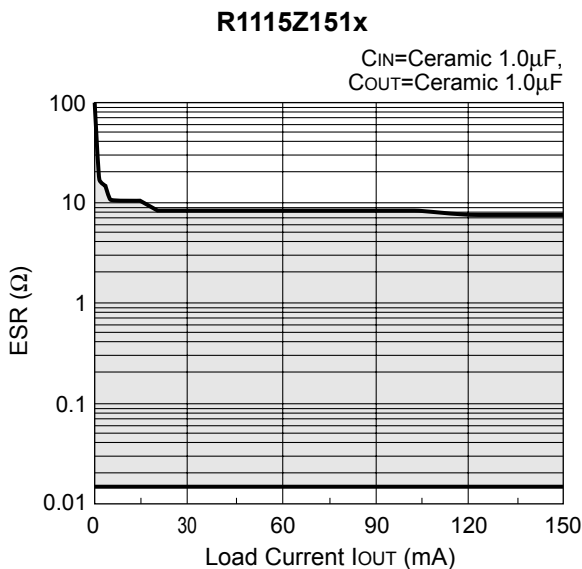

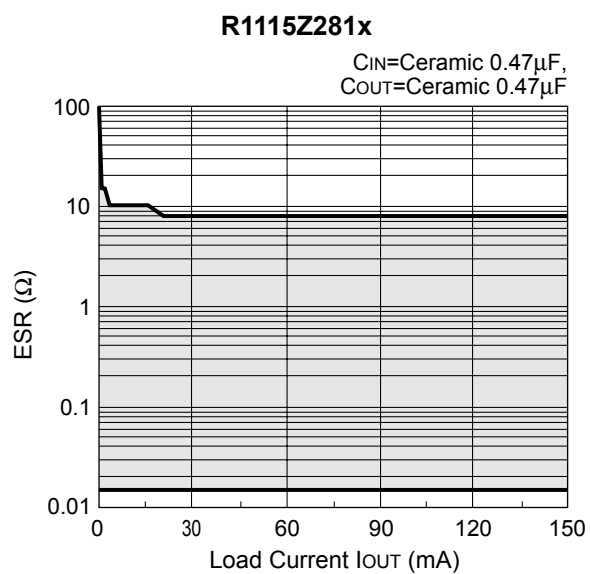
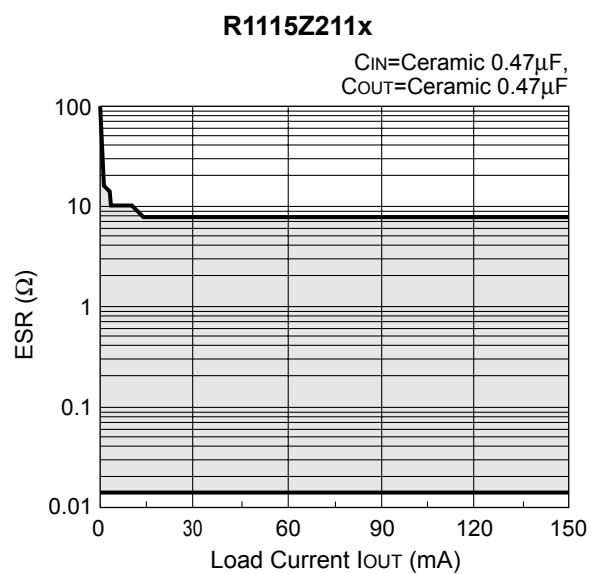

R1115Z SERIES MARK SPECIFICATION

● WLCSP-4-P4

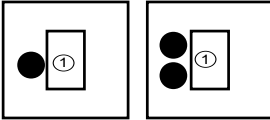

① : Lot Number

● Product Code vs. Marking

Part Number	Dot
R1115Z151A	● or ●●
R1115Z161A	● or ●●
R1115Z171A	● or ●●
R1115Z181A	● or ●●
R1115Z191A	● or ●●
R1115Z201A	● or ●●
R1115Z211A	● or ●●
R1115Z221A	● or ●●
R1115Z231A	● or ●●
R1115Z241A	● or ●●
R1115Z251A	● or ●●
R1115Z261A	● or ●●
R1115Z271A	● or ●●
R1115Z281A	● or ●●
R1115Z291A	● or ●●
R1115Z301A	● or ●●
R1115Z311A	● or ●●
R1115Z321A	● or ●●
R1115Z331A	● or ●●
R1115Z341A	● or ●●
R1115Z351A	● or ●●
R1115Z361A	● or ●●
R1115Z371A	● or ●●
R1115Z381A	● or ●●
R1115Z391A	● or ●●
R1115Z401A	● or ●●
R1115Z281A5	● or ●●

Part Number	Dot
R1115Z151B	● or ●●
R1115Z161B	● or ●●
R1115Z171B	● or ●●
R1115Z181B	● or ●●
R1115Z191B	● or ●●
R1115Z201B	● or ●●
R1115Z211B	● or ●●
R1115Z221B	● or ●●
R1115Z231B	● or ●●
R1115Z241B	● or ●●
R1115Z251B	● or ●●
R1115Z261B	● or ●●
R1115Z271B	● or ●●
R1115Z281B	● or ●●
R1115Z291B	● or ●●
R1115Z301B	● or ●●
R1115Z311B	● or ●●
R1115Z321B	● or ●●
R1115Z331B	● or ●●
R1115Z341B	● or ●●
R1115Z351B	● or ●●
R1115Z361B	● or ●●
R1115Z371B	● or ●●
R1115Z381B	● or ●●
R1115Z391B	● or ●●
R1115Z401B	● or ●●
R1115Z281B5	● or ●●

Part Number	Dot
R1115Z151D	● or ●●
R1115Z161D	● or ●●
R1115Z171D	● or ●●
R1115Z181D	● or ●●
R1115Z191D	● or ●●
R1115Z201D	● or ●●
R1115Z211D	● or ●●
R1115Z221D	● or ●●
R1115Z231D	● or ●●
R1115Z241D	● or ●●
R1115Z251D	● or ●●
R1115Z261D	● or ●●
R1115Z271D	● or ●●
R1115Z281D	● or ●●
R1115Z291D	● or ●●
R1115Z301D	● or ●●
R1115Z311D	● or ●●
R1115Z321D	● or ●●
R1115Z331D	● or ●●
R1115Z341D	● or ●●
R1115Z351D	● or ●●
R1115Z361D	● or ●●
R1115Z371D	● or ●●
R1115Z381D	● or ●●
R1115Z391D	● or ●●
R1115Z401D	● or ●●
R1115Z281D5	● or ●●