

HIGH RIPPLE-REJECTION LOW DROPOUT CMOS VOLTAGE REGULATOR WITH RESET FUNCTION

The S-1701 Series, developed based on CMOS technology, is a voltage regulator with a reset function and integrates a high-accuracy voltage detector with on-chip delay circuit and a positive voltage regulator with a low dropout voltage and high output voltage on one chip.

The S-1701 Series is available in many types according to the selection of the voltage detector block of the voltage detector, including a SENSE pin input product. A built-in low on-resistance transistor provides a low dropout voltage and large output current.

Small ceramic capacitors are available and an external capacitor for delay is needless. Small SOT-23-5 and SOT-89-5 packages realize high-density mounting.

■ Features

Regulator block

- Output voltage: 1.5 V to 5.0 V, selectable in 0.1 V steps.
- High-accuracy output voltage: $\pm 1.0\%$
- High peak current capability: 400 mA output is possible (at $V_{IN} \geq V_{OUT(S)} + 2.0 \text{ V}$)^{*1}
- Built-in ON/OFF circuit: Ensures long battery life.
During power-off: 0.1 μA typ., 1.0 μA max.
- Low ESR capacitor can be used: A ceramic capacitor of 1.0 μF or more can be used for the output capacitor.
- High ripple rejection: 70 dB typ. (at 1.0 kHz)
- Built-in overcurrent protector: Overcurrent of output transistor can be restricted.
- Operating voltage range: 2.0 V to 6.5 V

Detector block

- Output voltage: 1.5 V to 5.5 V, selectable in 0.1 V steps.
- High-accuracy output voltage: $\pm 1.0\%$
- Output mode: Nch open-drain active low output
- No need of an external capacitor for delay
- Three delay time settings: No delay (60 μs), 50 ms, 100 ms
- Operating voltage range: 0.8 V to 6.5 V

Whole regulator

- Low current consumption During operation: 85 μA typ.
- Lead-free, Sn 100%, halogen-free^{*2}

*1. Attention should be paid to the power dissipation of the package when the output current is large.

*2. Refer to “■ Product Name Structure” for details.

■ Applications

- Power supply and reset circuit for battery-powered devices
- Power supply for personal communication devices
- Power supply for home appliances

■ Packages

- SOT-23-5
- SOT-89-5

■ **Block Diagrams**

1. **S-1701 Series A/B/C/G/H/J types**

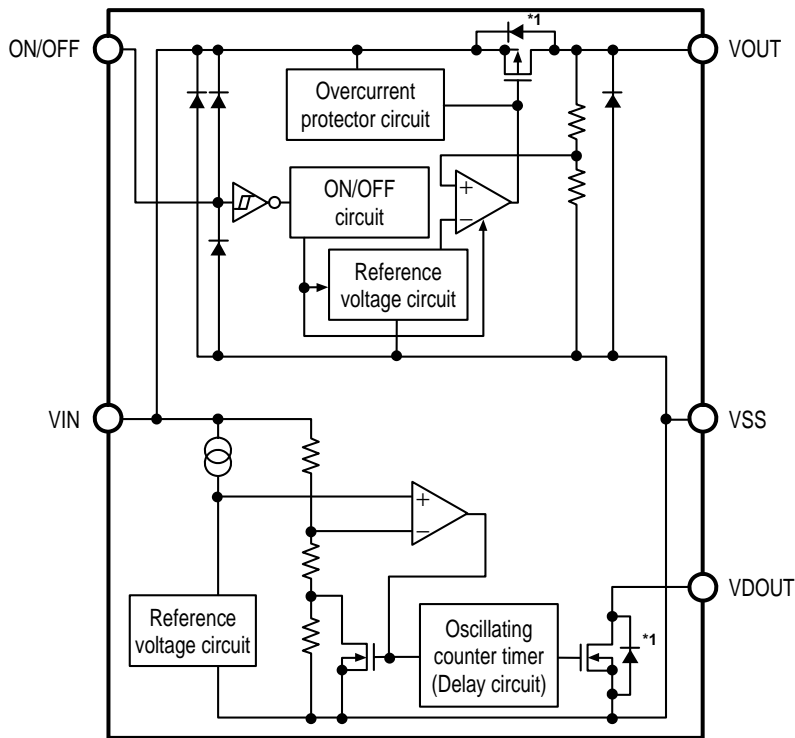

ON/OFF pin :	Provided
SENSE pin :	VIN connection

*1. Parasitic diode

Figure 1

2. **S-1701 Series D/E/F/K/L/M types**

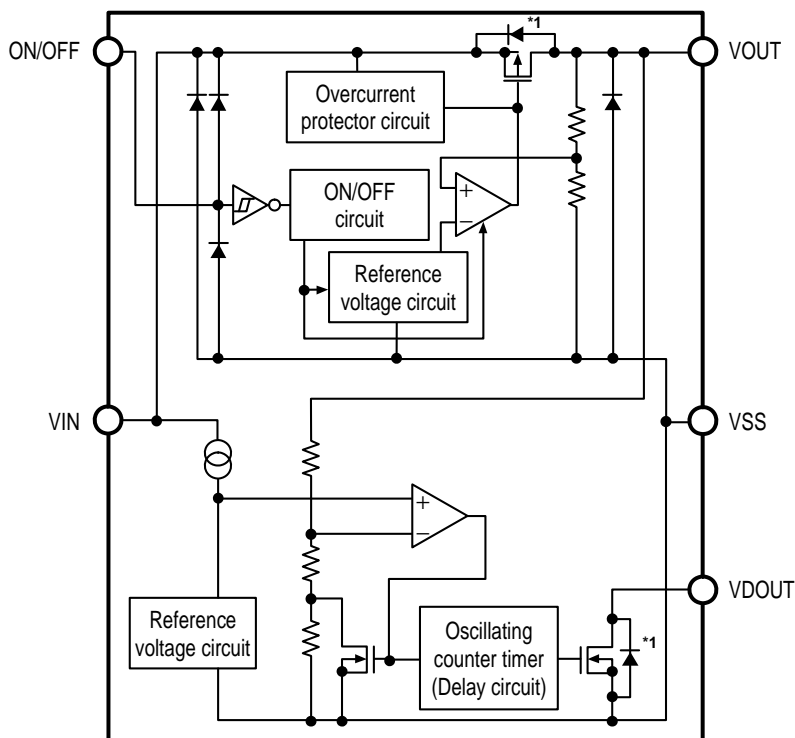

ON/OFF pin :	Provided
SENSE pin :	VOUT connection

*1. Parasitic diode

Figure 2

3. S-1701 Series N/P/Q types

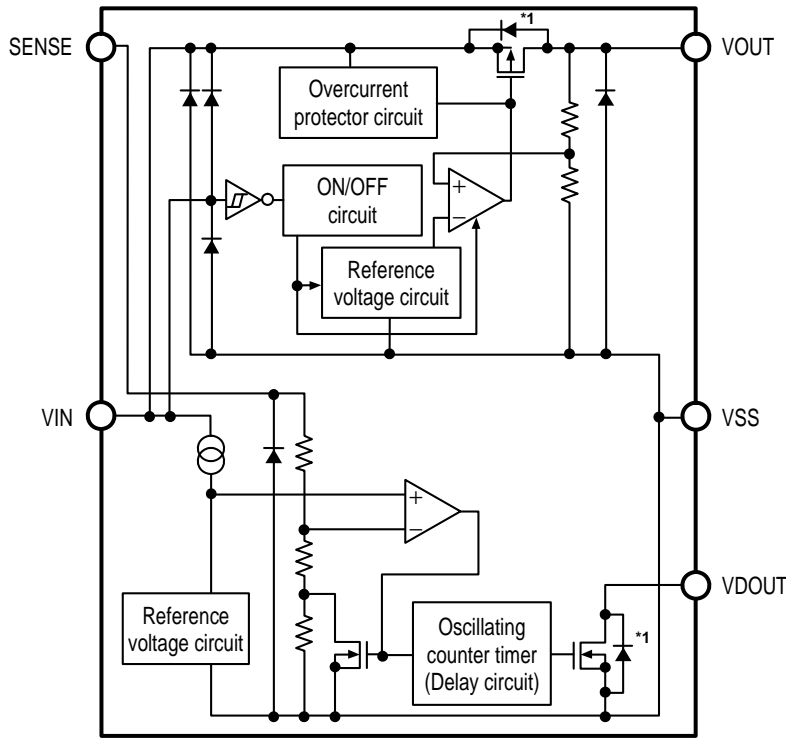

ON/OFF pin :	VIN connection
SENSE pin :	Provided

*1. Parasitic diode

Figure 3

4. S-1701 Series R/S/T types

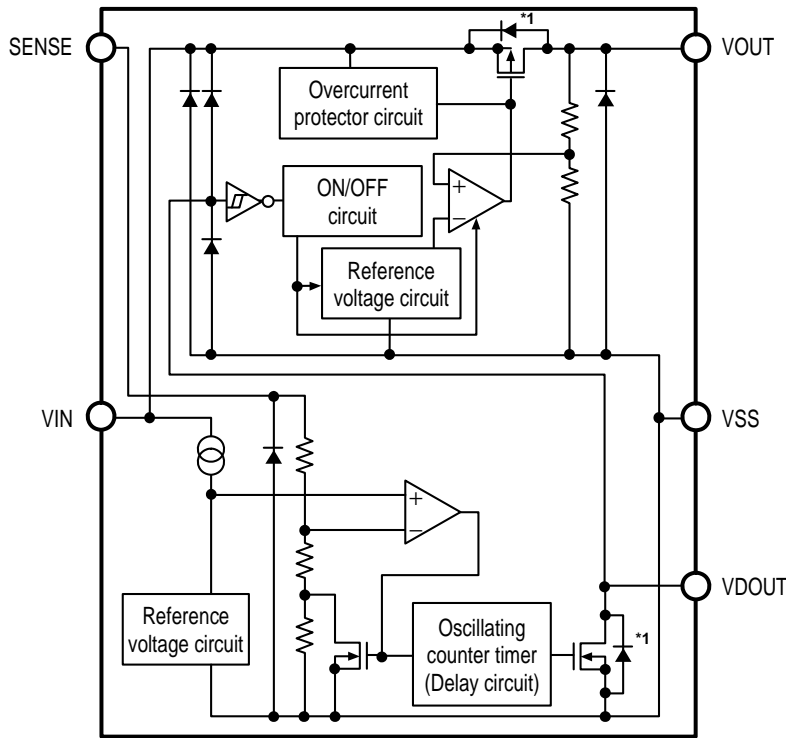

ON/OFF pin :	VDOUT connection
SENSE pin :	Provided

*1. Parasitic diode

Figure 4

5. S-1701 Series U/V/W types

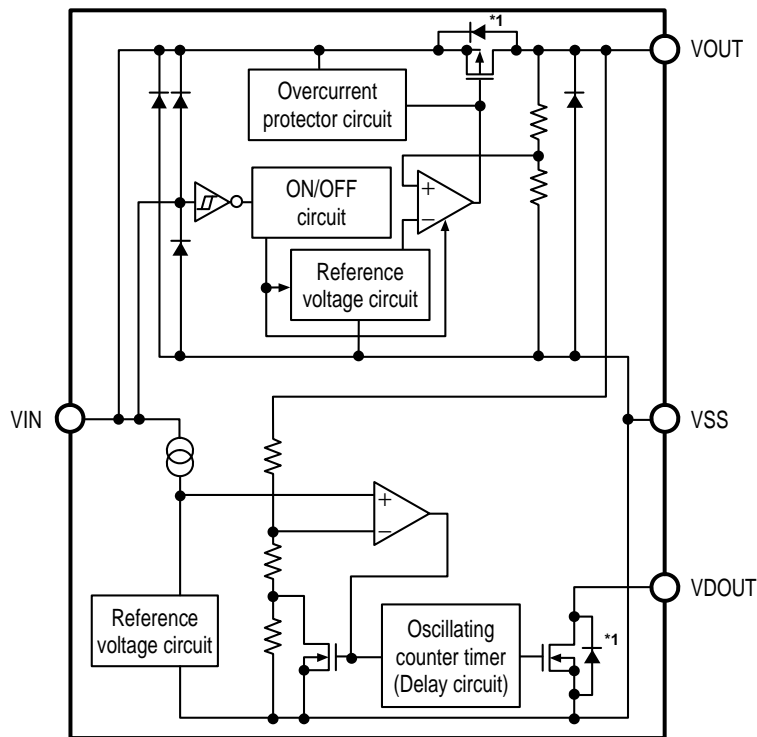

ON/OFF pin :	VIN connection
SENSE pin :	VOUT connection

*1. Parasitic diode

Figure 5

6. S-1701 Series X/Y/Z types

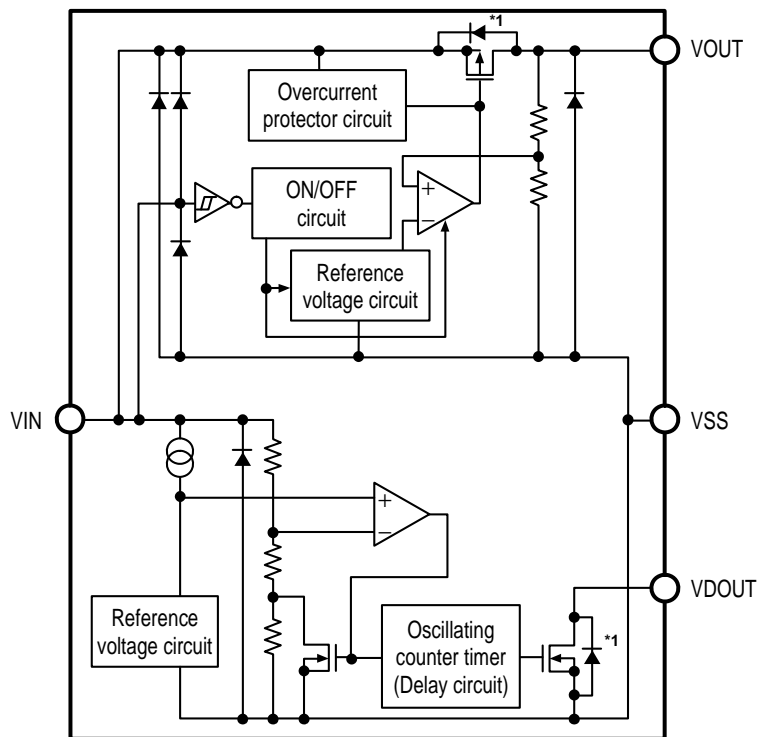

ON/OFF pin :	VIN connection
SENSE pin :	VIN connection

*1. Parasitic diode

Figure 6

■ **Product Name Structure**

The product types, output voltage, detection voltage, and package types for the S-1701 Series can be selected at the user's request. Refer to the "1. **Product name**" for the meanings of the characters in the product name, "2. **Function list according to product type**" for product types, "3. **Package**" regarding the package drawings and "4. **Product name list**" for the full product names.

1. **Product name**

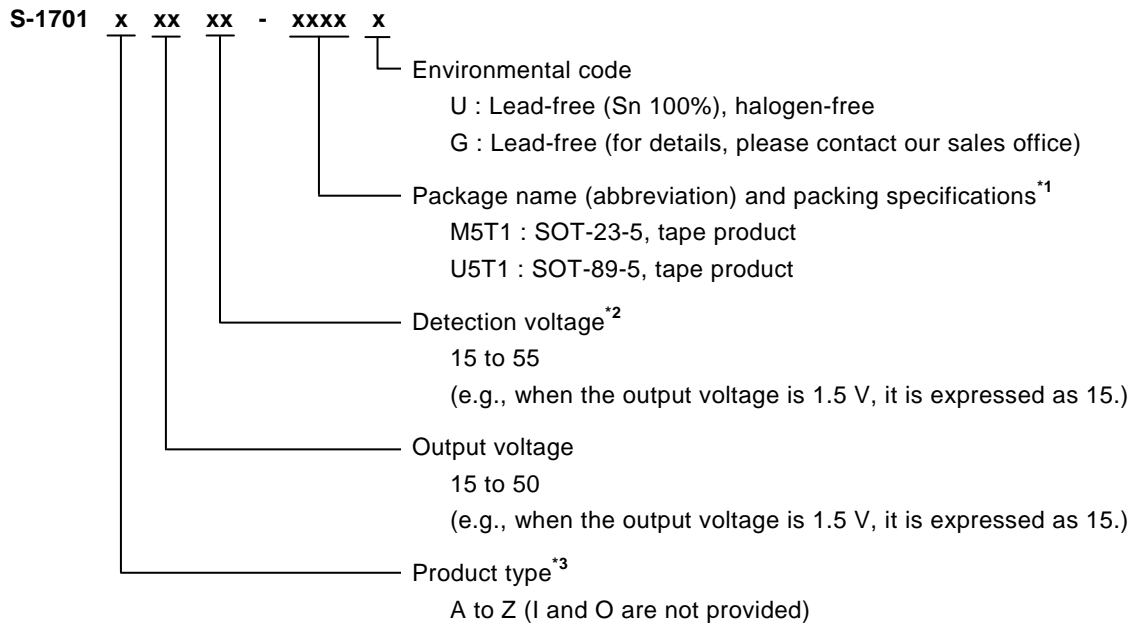

*1. Refer to the tape specifications at the end of this book.

*2. In the S-1701D to S-1701F, S-1701K to S-1701M, and S-1701U to S-1701W types (that detect output voltage), a reset signal may be output due to the undershoot of the output voltage when the input voltage or load current changes transiently. Therefore, set the detection voltage after sufficient evaluation using actual devices.

*3. Refer to the "2. **Function list according to product type**".

2. Function list according to product type

Table 1

Product Type	Regulator Block		Detector Block	
	ON/OFF Pin	ON/OFF Logic	SENSE Pin	Release Delay Time
A	Provided	Active high	VIN connection (pin not provided)	No delay (60 μs)
B	Provided	Active high	VIN connection (pin not provided)	50 ms
C	Provided	Active high	VIN connection (pin not provided)	100 ms
D	Provided	Active high	VOUT connection (pin not provided)	No delay (60 μs)
E	Provided	Active high	VOUT connection (pin not provided)	50 ms
F	Provided	Active high	VOUT connection (pin not provided)	100 ms
G	Provided	Active low	VIN connection (pin not provided)	No delay (60 μs)
H	Provided	Active low	VIN connection (pin not provided)	50 ms
J	Provided	Active low	VIN connection (pin not provided)	100 ms
K	Provided	Active low	VOUT connection (pin not provided)	No delay (60 μs)
L	Provided	Active low	VOUT connection (pin not provided)	50 ms
M	Provided	Active low	VOUT connection (pin not provided)	100 ms
N	VIN connection (pin not provided)	None	Provided	No delay (60 μs)
P	VIN connection (pin not provided)	None	Provided	50 ms
Q	VIN connection (pin not provided)	None	Provided	100 ms
R	VDOUT connection (pin not provided)	None	Provided	No delay (60 μs)
S	VDOUT connection (pin not provided)	None	Provided	50 ms
T	VDOUT connection (pin not provided)	None	Provided	100 ms
U	VIN connection (pin not provided)	None	VOUT connection (pin not provided)	No delay (60 μs)
V	VIN connection (pin not provided)	None	VOUT connection (pin not provided)	50 ms
W	VIN connection (pin not provided)	None	VOUT connection (pin not provided)	100 ms
X	VIN connection (pin not provided)	None	VIN connection (pin not provided)	No delay (60 μs)
Y	VIN connection (pin not provided)	None	VIN connection (pin not provided)	50 ms
Z	VIN connection (pin not provided)	None	VIN connection (pin not provided)	100 ms

3. Package

Package Name	Drawing Code		
	Package	Tape	Reel
SOT-23-5	MP005-A-P-SD	MP005-A-C-SD	MP005-A-R-SD
SOT-89-5	UP005-A-P-SD	UP005-A-C-SD	UP005-A-R-SD

4. Product name list

4.1 S-1701 Series A type

ON/OFF pin : Provided
 SENSE pin : VIN connection

ON/OFF logic : Active high
 Release delay time : No delay (60 μs)

Table 2

Output Voltage	Detection Voltage	SOT-23-5	SOT-89-5
1.5 V ± 1.0%	4.1 V ± 1.0%	S-1701A1541-M5T1x	–
1.8 V ± 1.0%	1.5 V ± 1.0%	S-1701A1815-M5T1x	S-1701A1815-U5T1x
2.5 V ± 1.0%	2.0 V ± 1.0%	S-1701A2520-M5T1x	S-1701A2520-U5T1x
2.5 V ± 1.0%	2.1 V ± 1.0%	S-1701A2521-M5T1x	S-1701A2521-U5T1x
2.5 V ± 1.0%	2.2 V ± 1.0%	S-1701A2522-M5T1x	S-1701A2522-U5T1x
2.7 V ± 1.0%	2.8 V ± 1.0%	S-1701A2728-M5T1x	–
2.8 V ± 1.0%	2.5 V ± 1.0%	S-1701A2825-M5T1x	–
2.8 V ± 1.0%	3.3 V ± 1.0%	S-1701A2833-M5T1x	–
3.0 V ± 1.0%	2.4 V ± 1.0%	S-1701A3024-M5T1x	S-1701A3024-U5T1x
3.0 V ± 1.0%	2.5 V ± 1.0%	S-1701A3025-M5T1x	S-1701A3025-U5T1x
3.0 V ± 1.0%	2.6 V ± 1.0%	S-1701A3026-M5T1x	S-1701A3026-U5T1x
3.3 V ± 1.0%	2.6 V ± 1.0%	S-1701A3326-M5T1x	S-1701A3326-U5T1x
3.3 V ± 1.0%	2.7 V ± 1.0%	S-1701A3327-M5T1x	S-1701A3327-U5T1x
3.3 V ± 1.0%	2.8 V ± 1.0%	S-1701A3328-M5T1x	S-1701A3328-U5T1x
3.3 V ± 1.0%	3.0 V ± 1.0%	S-1701A3330-M5T1x	–
3.3 V ± 1.0%	3.1 V ± 1.0%	S-1701A3331-M5T1x	–
3.4 V ± 1.0%	3.0 V ± 1.0%	S-1701A3430-M5T1x	S-1701A3430-U5T1x
5.0 V ± 1.0%	4.0 V ± 1.0%	S-1701A5040-M5T1x	S-1701A5040-U5T1x
5.0 V ± 1.0%	4.1 V ± 1.0%	S-1701A5041-M5T1x	S-1701A5041-U5T1x
5.0 V ± 1.0%	4.2 V ± 1.0%	S-1701A5042-M5T1x	S-1701A5042-U5T1x
5.0 V ± 1.0%	4.3 V ± 1.0%	S-1701A5043-M5T1x	S-1701A5043-U5T1x

Remark 1. Please contact our sales office for products with an output voltage or detection voltage other than those specified above.

2. x: G or U

3. Please select products of environmental code = U for Sn 100%, halogen-free products.

4.2 S-1701 Series B type

ON/OFF pin	: Provided	ON/OFF logic	: Active high
SENSE pin	: VIN connection	Release delay time	: 50 ms

Table 3

Output Voltage	Detection Voltage	SOT-23-5	SOT-89-5
1.8 V ± 1.0%	1.5 V ± 1.0%	S-1701B1815-M5T1x	S-1701B1815-U5T1x
1.8 V ± 1.0%	2.3 V ± 1.0%	S-1701B1823-M5T1x	–
1.8 V ± 1.0%	2.8 V ± 1.0%	S-1701B1828-M5T1x	–
2.5 V ± 1.0%	2.0 V ± 1.0%	S-1701B2520-M5T1x	S-1701B2520-U5T1x
2.5 V ± 1.0%	2.1 V ± 1.0%	S-1701B2521-M5T1x	S-1701B2521-U5T1x
2.5 V ± 1.0%	2.2 V ± 1.0%	S-1701B2522-M5T1x	S-1701B2522-U5T1x
3.0 V ± 1.0%	2.4 V ± 1.0%	S-1701B3024-M5T1x	S-1701B3024-U5T1x
3.0 V ± 1.0%	2.5 V ± 1.0%	S-1701B3025-M5T1x	S-1701B3025-U5T1x
3.0 V ± 1.0%	2.6 V ± 1.0%	S-1701B3026-M5T1x	S-1701B3026-U5T1x
3.3 V ± 1.0%	2.6 V ± 1.0%	S-1701B3326-M5T1x	S-1701B3326-U5T1x
3.3 V ± 1.0%	2.7 V ± 1.0%	S-1701B3327-M5T1x	S-1701B3327-U5T1x
3.3 V ± 1.0%	2.8 V ± 1.0%	S-1701B3328-M5T1x	S-1701B3328-U5T1x
3.3 V ± 1.0%	4.2 V ± 1.0%	–	S-1701B3342-U5T1x
3.4 V ± 1.0%	3.0 V ± 1.0%	S-1701B3430-M5T1x	S-1701B3430-U5T1x
5.0 V ± 1.0%	4.0 V ± 1.0%	S-1701B5040-M5T1x	S-1701B5040-U5T1x
5.0 V ± 1.0%	4.1 V ± 1.0%	S-1701B5041-M5T1x	S-1701B5041-U5T1x
5.0 V ± 1.0%	4.2 V ± 1.0%	S-1701B5042-M5T1x	S-1701B5042-U5T1x
5.0 V ± 1.0%	4.3 V ± 1.0%	S-1701B5043-M5T1x	S-1701B5043-U5T1x

4.3 S-1701 Series C type

ON/OFF pin	: Provided	ON/OFF logic	: Active high
SENSE pin	: VIN connection	Release delay time	: 100 ms

Table 4

Output Voltage	Detection Voltage	SOT-23-5	SOT-89-5
1.8 V ± 1.0%	1.5 V ± 1.0%	S-1701C1815-M5T1x	S-1701C1815-U5T1x
1.8 V ± 1.0%	3.0 V ± 1.0%	–	S-1701C1830-U5T1x
2.5 V ± 1.0%	2.0 V ± 1.0%	S-1701C2520-M5T1x	S-1701C2520-U5T1x
2.5 V ± 1.0%	2.1 V ± 1.0%	S-1701C2521-M5T1x	S-1701C2521-U5T1x
2.5 V ± 1.0%	2.2 V ± 1.0%	S-1701C2522-M5T1x	S-1701C2522-U5T1x
3.0 V ± 1.0%	2.4 V ± 1.0%	S-1701C3024-M5T1x	S-1701C3024-U5T1x
3.0 V ± 1.0%	2.5 V ± 1.0%	S-1701C3025-M5T1x	S-1701C3025-U5T1x
3.0 V ± 1.0%	2.6 V ± 1.0%	S-1701C3026-M5T1x	S-1701C3026-U5T1x
3.3 V ± 1.0%	2.6 V ± 1.0%	S-1701C3326-M5T1x	S-1701C3326-U5T1x
3.3 V ± 1.0%	2.7 V ± 1.0%	S-1701C3327-M5T1x	S-1701C3327-U5T1x
3.3 V ± 1.0%	2.8 V ± 1.0%	S-1701C3328-M5T1x	S-1701C3328-U5T1x
3.3 V ± 1.0%	3.0 V ± 1.0%	S-1701C3330-M5T1x	–
3.4 V ± 1.0%	3.0 V ± 1.0%	S-1701C3430-M5T1x	S-1701C3430-U5T1x
5.0 V ± 1.0%	4.0 V ± 1.0%	S-1701C5040-M5T1x	S-1701C5040-U5T1x
5.0 V ± 1.0%	4.1 V ± 1.0%	S-1701C5041-M5T1x	S-1701C5041-U5T1x
5.0 V ± 1.0%	4.2 V ± 1.0%	S-1701C5042-M5T1x	S-1701C5042-U5T1x
5.0 V ± 1.0%	4.3 V ± 1.0%	S-1701C5043-M5T1x	S-1701C5043-U5T1x

- Remark 1.** Please contact our sales office for products with an output voltage or detection voltage other than those specified above.
2. x: G or U
 3. Please select products of environmental code = U for Sn 100%, halogen-free products.

4.4 S-1701 Series D type

ON/OFF pin : Provided
 SENSE pin : VOUT connection
 ON/OFF logic : Active high
 Release delay time : No delay (60 μs)

Table 5

Output Voltage	Detection Voltage	SOT-23-5	SOT-89-5
1.8 V ± 1.0%	1.5 V ± 1.0%	S-1701D1815-M5T1x	S-1701D1815-U5T1x
1.8 V ± 1.0%	1.6 V ± 1.0%	S-1701D1816-M5T1x	–
1.8 V ± 1.0%	1.7 V ± 1.0%	S-1701D1817-M5T1x	–
2.5 V ± 1.0%	2.0 V ± 1.0%	S-1701D2520-M5T1x	S-1701D2520-U5T1x
2.5 V ± 1.0%	2.1 V ± 1.0%	S-1701D2521-M5T1x	S-1701D2521-U5T1x
2.5 V ± 1.0%	2.2 V ± 1.0%	S-1701D2522-M5T1x	S-1701D2522-U5T1x
2.5 V ± 1.0%	2.3 V ± 1.0%	S-1701D2523-M5T1x	–
2.5 V ± 1.0%	2.4 V ± 1.0%	S-1701D2524-M5T1x	–
2.5 V ± 1.0%	2.6 V ± 1.0%	S-1701D2526-M5T1x	–
2.7 V ± 1.0%	2.2 V ± 1.0%	S-1701D2722-M5T1x	–
3.0 V ± 1.0%	2.4 V ± 1.0%	S-1701D3024-M5T1x	S-1701D3024-U5T1x
3.0 V ± 1.0%	2.5 V ± 1.0%	S-1701D3025-M5T1x	S-1701D3025-U5T1x
3.0 V ± 1.0%	2.6 V ± 1.0%	S-1701D3026-M5T1x	S-1701D3026-U5T1x
3.3 V ± 1.0%	2.6 V ± 1.0%	S-1701D3326-M5T1x	S-1701D3326-U5T1x
3.3 V ± 1.0%	2.7 V ± 1.0%	S-1701D3327-M5T1x	S-1701D3327-U5T1x
3.3 V ± 1.0%	2.8 V ± 1.0%	S-1701D3328-M5T1x	S-1701D3328-U5T1x
3.3 V ± 1.0%	3.0 V ± 1.0%	S-1701D3330-M5T1x	–
3.4 V ± 1.0%	3.0 V ± 1.0%	S-1701D3430-M5T1x	S-1701D3430-U5T1x
5.0 V ± 1.0%	4.0 V ± 1.0%	S-1701D5040-M5T1x	S-1701D5040-U5T1x
5.0 V ± 1.0%	4.1 V ± 1.0%	S-1701D5041-M5T1x	S-1701D5041-U5T1x
5.0 V ± 1.0%	4.2 V ± 1.0%	S-1701D5042-M5T1x	S-1701D5042-U5T1x
5.0 V ± 1.0%	4.3 V ± 1.0%	S-1701D5043-M5T1x	S-1701D5043-U5T1x

Remark 1. Please contact our sales office for products with an output voltage or detection voltage other than those specified above.

2. x: G or U

3. Please select products of environmental code = U for Sn 100%, halogen-free products.

4. 11 S-1701 Series P type

ON/OFF pin : VIN connection ON/OFF logic : None
 SENSE pin : Provided Release delay time : 50 ms

Table 12

Output Voltage	Detection Voltage	SOT-23-5	SOT-89-5
1.5 V ± 1.0%	1.5 V ± 1.0%	S-1701P1515-M5T1x	S-1701P1515-U5T1x
1.5 V ± 1.0%	2.7 V ± 1.0%	S-1701P1527-M5T1x	—
1.8 V ± 1.0%	1.5 V ± 1.0%	S-1701P1815-M5T1x	S-1701P1815-U5T1x
2.5 V ± 1.0%	1.5 V ± 1.0%	S-1701P2515-M5T1x	S-1701P2515-U5T1x
2.7 V ± 1.0%	1.5 V ± 1.0%	S-1701P2715-M5T1x	S-1701P2715-U5T1x
2.8 V ± 1.0%	4.3 V ± 1.0%	—	S-1701P2843-U5T1x
2.8 V ± 1.0%	4.4 V ± 1.0%	—	S-1701P2844-U5T1x
3.0 V ± 1.0%	1.5 V ± 1.0%	S-1701P3015-M5T1x	S-1701P3015-U5T1x
3.3 V ± 1.0%	1.5 V ± 1.0%	S-1701P3315-M5T1x	S-1701P3315-U5T1x
5.0 V ± 1.0%	1.5 V ± 1.0%	S-1701P5015-M5T1x	S-1701P5015-U5T1x

4. 12 S-1701 Series Q type

ON/OFF pin : VIN connection ON/OFF logic : None
 SENSE pin : Provided Release delay time : 100 ms

Table 13

Output Voltage	Detection Voltage	SOT-23-5	SOT-89-5
1.5 V ± 1.0%	1.5 V ± 1.0%	S-1701Q1515-M5T1x	S-1701Q1515-U5T1x
1.8 V ± 1.0%	1.5 V ± 1.0%	S-1701Q1815-M5T1x	S-1701Q1815-U5T1x
2.5 V ± 1.0%	1.5 V ± 1.0%	S-1701Q2515-M5T1x	S-1701Q2515-U5T1x
2.7 V ± 1.0%	1.5 V ± 1.0%	S-1701Q2715-M5T1x	S-1701Q2715-U5T1x
3.0 V ± 1.0%	1.5 V ± 1.0%	S-1701Q3015-M5T1x	S-1701Q3015-U5T1x
3.2 V ± 1.0%	2.7 V ± 1.0%	—	S-1701Q3227-U5T1x
3.2 V ± 1.0%	4.2 V ± 1.0%	—	S-1701Q3242-U5T1x
3.3 V ± 1.0%	1.5 V ± 1.0%	S-1701Q3315-M5T1x	S-1701Q3315-U5T1x
5.0 V ± 1.0%	1.5 V ± 1.0%	S-1701Q5015-M5T1x	S-1701Q5015-U5T1x

Remark 1. Please contact our sales office for products with an output voltage or detection voltage other than those specified above.

2. x: G or U
3. Please select products of environmental code = U for Sn 100%, halogen-free products.

4. 13 S-1701 Series R type

ON/OFF pin : VDOUT connection ON/OFF logic : None
 SENSE pin : Provided Release delay time : No delay (60 μs)

Table 14

Output Voltage	Detection Voltage	SOT-23-5	SOT-89-5
1.5 V ± 1.0%	1.5 V ± 1.0%	S-1701R1515-M5T1x	S-1701R1515-U5T1x
1.8 V ± 1.0%	1.5 V ± 1.0%	S-1701R1815-M5T1x	S-1701R1815-U5T1x
2.5 V ± 1.0%	1.5 V ± 1.0%	S-1701R2515-M5T1x	S-1701R2515-U5T1x
2.7 V ± 1.0%	1.5 V ± 1.0%	S-1701R2715-M5T1x	S-1701R2715-U5T1x
3.0 V ± 1.0%	1.5 V ± 1.0%	S-1701R3015-M5T1x	S-1701R3015-U5T1x
3.3 V ± 1.0%	1.5 V ± 1.0%	S-1701R3315-M5T1x	S-1701R3315-U5T1x
5.0 V ± 1.0%	1.5 V ± 1.0%	S-1701R5015-M5T1x	S-1701R5015-U5T1x

4. 14 S-1701 Series S type

ON/OFF pin : VDOUT connection ON/OFF logic : None
 SENSE pin : Provided Release delay time : 50 ms

Table 15

Output Voltage	Detection Voltage	SOT-23-5	SOT-89-5
1.5 V ± 1.0%	1.5 V ± 1.0%	S-1701S1515-M5T1x	S-1701S1515-U5T1x
1.8 V ± 1.0%	1.5 V ± 1.0%	S-1701S1815-M5T1x	S-1701S1815-U5T1x
2.5 V ± 1.0%	1.5 V ± 1.0%	S-1701S2515-M5T1x	S-1701S2515-U5T1x
2.7 V ± 1.0%	1.5 V ± 1.0%	S-1701S2715-M5T1x	S-1701S2715-U5T1x
3.0 V ± 1.0%	1.5 V ± 1.0%	S-1701S3015-M5T1x	S-1701S3015-U5T1x
3.3 V ± 1.0%	1.5 V ± 1.0%	S-1701S3315-M5T1x	S-1701S3315-U5T1x
5.0 V ± 1.0%	1.5 V ± 1.0%	S-1701S5015-M5T1x	S-1701S5015-U5T1x

4. 15 S-1701 Series T type

ON/OFF pin : VDOUT connection ON/OFF logic : None
 SENSE pin : Provided Release delay time : 100 ms

Table 16

Output Voltage	Detection Voltage	SOT-23-5	SOT-89-5
1.5 V ± 1.0%	1.5 V ± 1.0%	S-1701T1515-M5T1x	S-1701T1515-U5T1x
1.8 V ± 1.0%	1.5 V ± 1.0%	S-1701T1815-M5T1x	S-1701T1815-U5T1x
2.5 V ± 1.0%	1.5 V ± 1.0%	S-1701T2515-M5T1x	S-1701T2515-U5T1x
2.7 V ± 1.0%	1.5 V ± 1.0%	S-1701T2715-M5T1x	S-1701T2715-U5T1x
3.0 V ± 1.0%	1.5 V ± 1.0%	S-1701T3015-M5T1x	S-1701T3015-U5T1x
3.3 V ± 1.0%	1.5 V ± 1.0%	S-1701T3315-M5T1x	S-1701T3315-U5T1x
3.3 V ± 1.0%	2.5 V ± 1.0%	S-1701T3325-M5T1x	—
5.0 V ± 1.0%	1.5 V ± 1.0%	S-1701T5015-M5T1x	S-1701T5015-U5T1x

Remark 1. Please contact our sales office for products with an output voltage or detection voltage other than those specified above.

2. x: G or U

3. Please select products of environmental code = U for Sn 100%, halogen-free products.

4. 16 S-1701 Series U type

ON/OFF pin : VIN connection ON/OFF logic : None
 SENSE pin : VOUT connection Release delay time : No delay (60 μs)

Table 17

Output Voltage	Detection Voltage	SOT-23-5	SOT-89-5
1.8 V ± 1.0%	1.5 V ± 1.0%	S-1701U1815-M5T1x	S-1701U1815-U5T1x
2.5 V ± 1.0%	2.0 V ± 1.0%	S-1701U2520-M5T1x	S-1701U2520-U5T1x
2.5 V ± 1.0%	2.1 V ± 1.0%	S-1701U2521-M5T1x	S-1701U2521-U5T1x
2.5 V ± 1.0%	2.2 V ± 1.0%	S-1701U2522-M5T1x	S-1701U2522-U5T1x
3.0 V ± 1.0%	2.4 V ± 1.0%	S-1701U3024-M5T1x	S-1701U3024-U5T1x
3.0 V ± 1.0%	2.5 V ± 1.0%	S-1701U3025-M5T1x	S-1701U3025-U5T1x
3.0 V ± 1.0%	2.6 V ± 1.0%	S-1701U3026-M5T1x	S-1701U3026-U5T1x
3.3 V ± 1.0%	2.6 V ± 1.0%	S-1701U3326-M5T1x	S-1701U3326-U5T1x
3.3 V ± 1.0%	2.7 V ± 1.0%	S-1701U3327-M5T1x	S-1701U3327-U5T1x
3.3 V ± 1.0%	2.8 V ± 1.0%	S-1701U3328-M5T1x	S-1701U3328-U5T1x
3.4 V ± 1.0%	3.0 V ± 1.0%	S-1701U3430-M5T1x	S-1701U3430-U5T1x
5.0 V ± 1.0%	4.0 V ± 1.0%	S-1701U5040-M5T1x	S-1701U5040-U5T1x
5.0 V ± 1.0%	4.1 V ± 1.0%	S-1701U5041-M5T1x	S-1701U5041-U5T1x
5.0 V ± 1.0%	4.2 V ± 1.0%	S-1701U5042-M5T1x	S-1701U5042-U5T1x
5.0 V ± 1.0%	4.3 V ± 1.0%	S-1701U5043-M5T1x	S-1701U5043-U5T1x

4. 17 S-1701 Series V type

ON/OFF pin : VIN connection ON/OFF logic : None
 SENSE pin : VOUT connection Release delay time : 50 ms

Table 18

Output Voltage	Detection Voltage	SOT-23-5	SOT-89-5
1.8 V ± 1.0%	1.5 V ± 1.0%	S-1701V1815-M5T1x	S-1701V1815-U5T1x
2.5 V ± 1.0%	2.0 V ± 1.0%	S-1701V2520-M5T1x	S-1701V2520-U5T1x
2.5 V ± 1.0%	2.1 V ± 1.0%	S-1701V2521-M5T1x	S-1701V2521-U5T1x
2.5 V ± 1.0%	2.2 V ± 1.0%	S-1701V2522-M5T1x	S-1701V2522-U5T1x
3.0 V ± 1.0%	2.4 V ± 1.0%	S-1701V3024-M5T1x	S-1701V3024-U5T1x
3.0 V ± 1.0%	2.5 V ± 1.0%	S-1701V3025-M5T1x	S-1701V3025-U5T1x
3.0 V ± 1.0%	2.6 V ± 1.0%	S-1701V3026-M5T1x	S-1701V3026-U5T1x
3.2 V ± 1.0%	2.7 V ± 1.0%	S-1701V3227-M5T1x	—
3.3 V ± 1.0%	2.5 V ± 1.0%	S-1701V3325-M5T1x	—
3.3 V ± 1.0%	2.6 V ± 1.0%	S-1701V3326-M5T1x	S-1701V3326-U5T1x
3.3 V ± 1.0%	2.7 V ± 1.0%	S-1701V3327-M5T1x	S-1701V3327-U5T1x
3.3 V ± 1.0%	2.8 V ± 1.0%	S-1701V3328-M5T1x	S-1701V3328-U5T1x
3.4 V ± 1.0%	3.0 V ± 1.0%	S-1701V3430-M5T1x	S-1701V3430-U5T1x
5.0 V ± 1.0%	4.0 V ± 1.0%	S-1701V5040-M5T1x	S-1701V5040-U5T1x
5.0 V ± 1.0%	4.1 V ± 1.0%	S-1701V5041-M5T1x	S-1701V5041-U5T1x
5.0 V ± 1.0%	4.2 V ± 1.0%	S-1701V5042-M5T1x	S-1701V5042-U5T1x
5.0 V ± 1.0%	4.3 V ± 1.0%	S-1701V5043-M5T1x	S-1701V5043-U5T1x

Remark 1. Please contact our sales office for products with an output voltage or detection voltage other than those specified above.

2. x: G or U

3. Please select products of environmental code = U for Sn 100%, halogen-free products.

4. 18 S-1701 Series W type

ON/OFF pin : VIN connection ON/OFF logic : None
 SENSE pin : VOUT connection Release delay time : 100 ms

Table 19

Output Voltage	Detection Voltage	SOT-23-5	SOT-89-5
1.6 V ± 1.0%	2.6 V ± 1.0%	S-1701W1626-M5T1x	–
1.8 V ± 1.0%	1.5 V ± 1.0%	S-1701W1815-M5T1x	S-1701W1815-U5T1x
2.5 V ± 1.0%	2.0 V ± 1.0%	S-1701W2520-M5T1x	S-1701W2520-U5T1x
2.5 V ± 1.0%	2.1 V ± 1.0%	S-1701W2521-M5T1x	S-1701W2521-U5T1x
2.5 V ± 1.0%	2.2 V ± 1.0%	S-1701W2522-M5T1x	S-1701W2522-U5T1x
3.0 V ± 1.0%	2.4 V ± 1.0%	S-1701W3024-M5T1x	S-1701W3024-U5T1x
3.0 V ± 1.0%	2.5 V ± 1.0%	S-1701W3025-M5T1x	S-1701W3025-U5T1x
3.0 V ± 1.0%	2.6 V ± 1.0%	S-1701W3026-M5T1x	S-1701W3026-U5T1x
3.2 V ± 1.0%	2.7 V ± 1.0%	S-1701W3227-M5T1x	–
3.3 V ± 1.0%	2.4 V ± 1.0%	–	S-1701W3324-U5T1x
3.3 V ± 1.0%	2.6 V ± 1.0%	S-1701W3326-M5T1x	S-1701W3326-U5T1x
3.3 V ± 1.0%	2.7 V ± 1.0%	S-1701W3327-M5T1x	S-1701W3327-U5T1x
3.3 V ± 1.0%	2.8 V ± 1.0%	S-1701W3328-M5T1x	S-1701W3328-U5T1x
3.4 V ± 1.0%	3.0 V ± 1.0%	S-1701W3430-M5T1x	S-1701W3430-U5T1x
5.0 V ± 1.0%	4.0 V ± 1.0%	S-1701W5040-M5T1x	S-1701W5040-U5T1x
5.0 V ± 1.0%	4.1 V ± 1.0%	S-1701W5041-M5T1x	S-1701W5041-U5T1x
5.0 V ± 1.0%	4.2 V ± 1.0%	S-1701W5042-M5T1x	S-1701W5042-U5T1x
5.0 V ± 1.0%	4.3 V ± 1.0%	S-1701W5043-M5T1x	S-1701W5043-U5T1x

4. 19 S-1701 Series X type

ON/OFF pin : VIN connection ON/OFF logic : None
 SENSE pin : VIN connection Release delay time : No delay (60 μs)

Table 20

Output Voltage	Detection Voltage	SOT-23-5	SOT-89-5
1.5 V ± 1.0%	2.5 V ± 1.0%	S-1701X1525-M5T1x	–
1.8 V ± 1.0%	2.5 V ± 1.0%	S-1701X1825-M5T1x	–
2.2 V ± 1.0%	1.9 V ± 1.0%	S-1701X2219-M5T1x	–
3.0 V ± 1.0%	2.5 V ± 1.0%	S-1701X3025-M5T1x	–
3.2 V ± 1.0%	2.8 V ± 1.0%	S-1701X3228-M5T1x	S-1701X3228-U5T1x
3.3 V ± 1.0%	1.5 V ± 1.0%	S-1701X3315-M5T1x	–
3.3 V ± 1.0%	3.0 V ± 1.0%	–	S-1701X3330-U5T1x
3.3 V ± 1.0%	4.2 V ± 1.0%	–	S-1701X3342-U5T1x

Remark 1. Please contact our sales office for products with an output voltage or detection voltage other than those specified above.

2. x: G or U

3. Please select products of environmental code = U for Sn 100%, halogen-free products.

4. 20 S-1701 Series Y type

ON/OFF pin : VIN connection ON/OFF logic : None
 SENSE pin : VIN connection Release delay time : 50 ms

Table 21

Output Voltage	Detection Voltage	SOT-23-5	SOT-89-5
3.2 V ± 1.0%	2.8 V ± 1.0%	S-1701Y3228-M5T1x	S-1701Y3228-U5T1x
3.3 V ± 1.0%	3.0 V ± 1.0%	–	S-1701Y3330-U5T1x
3.3 V ± 1.0%	4.0 V ± 1.0%	–	S-1701Y3340-U5T1x
3.3 V ± 1.0%	4.2 V ± 1.0%	S-1701Y3342-M5T1x	S-1701Y3342-U5T1x

4. 21 S-1701 Series Z type

ON/OFF pin : VIN connection ON/OFF logic : None
 SENSE pin : VIN connection Release delay time : 100 ms

Table 22

Output Voltage	Detection Voltage	SOT-23-5	SOT-89-5
1.6 V ± 1.0%	2.6 V ± 1.0%	S-1701Z1626-M5T1x	–
1.8 V ± 1.0%	2.6 V ± 1.0%	S-1701Z1826-M5T1x	–
3.2 V ± 1.0%	2.8 V ± 1.0%	S-1701Z3228-M5T1x	S-1701Z3228-U5T1x
3.3 V ± 1.0%	3.0 V ± 1.0%	S-1701Z3330-M5T1x	–

- Remark 1.** Please contact our sales office for products with an output voltage or detection voltage other than those specified above.
2. x: G or U
 3. Please select products of environmental code = U for Sn 100%, halogen-free products.

■ Pin Configurations

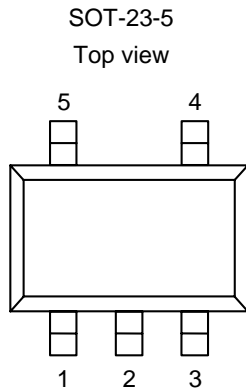

Figure 7

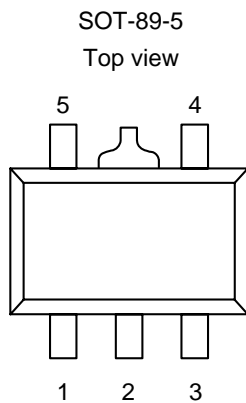

Figure 8

Table 23

Pin No.	Symbol	Description
1	VIN	Input voltage pin
2	VSS	GND pin
3	ON/OFF	Shutdown pin (A, B, C, D, E, F, G, H, J, K, L, M types)
3	SENSE	Detector SENSE pin (N, P, Q, R, S, T types)
3	NC*1	No connection (U, V, W, X, Y, Z types)
4	VDOOUT	Detector output voltage pin*2
5	VOUT	Regulator output voltage pin

*1. The NC pin is electrically open.

The NC pin can be connected to VIN or VSS.

*2. Due to Nch open drain products, please use the pull-up resistor.

Table 24

Pin No.	Symbol	Description
1	VIN	Input voltage pin
2	VSS	GND pin
3	VOUT	Regulator output voltage pin
4	VDOOUT	Detector output voltage pin*2
5	ON/OFF	Shutdown pin (A, B, C, D, E, F, G, H, J, K, L, M types)
5	SENSE	Detector SENSE pin (N, P, Q, R, S, T types)
5	NC*1	No connection (U, V, W, X, Y, Z types)

*1. The NC pin is electrically open.

The NC pin can be connected to VIN or VSS.

*2. Due to Nch open drain products, please use the pull-up resistor.

■ Absolute Maximum Ratings

Table 25

(Ta = 25°C unless otherwise specified)

Item	Symbol	Absolute Maximum Rating	Unit	
Input voltage	V _{IN}	V _{SS} - 0.3 to V _{SS} + 7	V	
	V _{ON/OFF}	V _{SS} - 0.3 to V _{IN} + 0.3	V	
	V _{SENSE}	V _{SS} - 0.3 to V _{SS} + 7	V	
Regulator output voltage	V _{OUT}	V _{SS} - 0.3 to V _{IN} + 0.3	V	
Detector output voltage	V _{DOUT}	V _{SS} - 0.3 to V _{SS} + 7	V	
		V _{SS} - 0.3 to V _{IN} + 0.3	V	
Power dissipation	P _D	300 (When not mounted on board)	mW	
				600*1
		SOT-89-5	500 (When not mounted on board)	mW
Operating ambient temperature	T _{opr}	-40 to +85	°C	
Storage temperature	T _{stg}	-40 to +125	°C	

*1. When mounted on board

[Mounted board]

- (1) Board size : 114.3 mm × 76.2 mm × t1.6 mm
- (2) Board name : JEDEC STANDARD51-7

Caution The absolute maximum ratings are rated values exceeding which the product could suffer physical damage. These values must therefore not be exceeded under any conditions.

(1) When mounted on board

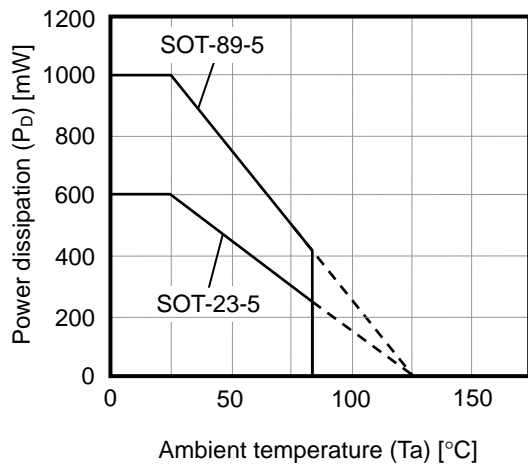

(2) When not mounted on board

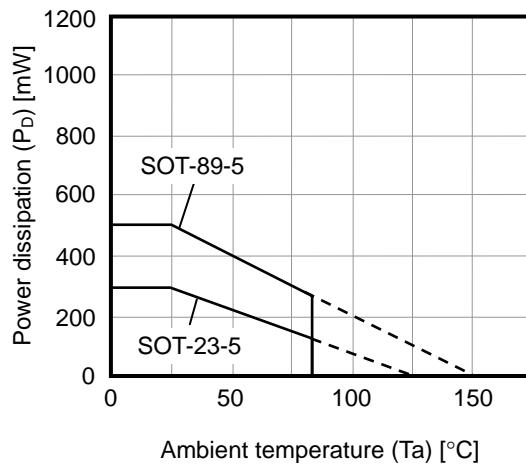

Figure 9 Power Dissipation of Package

■ Electrical Characteristics

1. S-1701 Series A/B/C/G/H/J types

Table 26 (1 / 2)

(Ta = 25°C unless otherwise specified)

Item	Symbol	Conditions	Min.	Typ.	Max.	Unit	Test Circuit
Current consumption	I _{SS}	V _{IN} = V _{OUT(S)} + 1.0 V, no load	–	85	110	μA	3

Regulator block

Item	Symbol	Conditions	Min.	Typ.	Max.	Unit	Test Circuit	
Output voltage ^{*1}	V _{OUT(E)}	V _{IN} = V _{OUT(S)} + 1.0 V, I _{OUT} = 30 mA	V _{OUT(S)} × 0.99	V _{OUT(S)}	V _{OUT(S)} × 1.01	V	1	
Output current ^{*2}	I _{OUT}	V _{IN} ≥ V _{OUT(S)} + 2.0 V When V _{OUT(S)} = 4.5 V or higher, V _{IN} = 6.5 V	400 ^{*7}	–	–	mA	2	
Dropout voltage ^{*3}	V _{drop}	I _{OUT} = 100 mA	1.5 V ≤ V _{OUT(S)} ≤ 1.6 V	0.50	0.54	0.58	V	1
			1.7 V ≤ V _{OUT(S)} ≤ 1.8 V	–	0.34	0.38	V	1
			1.9 V ≤ V _{OUT(S)} ≤ 2.3 V	–	0.19	0.29	V	1
			2.4 V ≤ V _{OUT(S)} ≤ 2.7 V	–	0.16	0.25	V	1
			2.8 V ≤ V _{OUT(S)} ≤ 5.0 V	–	0.14	0.21	V	1
Line regulation	$\frac{\Delta V_{OUT1}}{\Delta V_{IN} \cdot V_{OUT}}$	V _{OUT(S)} + 0.5 V ≤ V _{IN} ≤ 6.5 V, I _{OUT} = 30 mA	–	0.05	0.2	%/V	1	
Load regulation	ΔV _{OUT2}	V _{IN} = V _{OUT(S)} + 1.0 V, 1.0 mA ≤ I _{OUT} ≤ 100 mA	–	20	40	mV	1	
Output voltage temperature coefficient ^{*4}	$\frac{\Delta V_{OUT}}{\Delta T_a \cdot V_{OUT}}$	V _{IN} = V _{OUT(S)} + 1.0 V, I _{OUT} = 30 mA –40°C ≤ Ta ≤ +85°C ^{*8}	–	±100	±350	ppm/°C	1	
Current consumption during operation	I _{SSR}	V _{IN} = V _{OUT(S)} + 1.0 V, ON/OFF pin = ON, no load	–	80	103	μA	3	
Input voltage	V _{IN}	–	2	–	6.5	V	–	
ON/OFF pin input voltage “H”	V _{SH}	V _{IN} = V _{OUT(S)} + 1.0 V, R _L = 1.0 kΩ	1.5	–	–	V	4	
ON/OFF pin input voltage “L”	V _{SL}	V _{IN} = V _{OUT(S)} + 1.0 V, R _L = 1.0 kΩ	–	–	0.3	V	4	
ON/OFF pin input current “H”	I _{SH}	V _{IN} = 6.5 V, V _{ON/OFF} = 6.5 V	–0.1	–	0.1	μA	4	
ON/OFF pin input current “L”	I _{SL}	V _{IN} = 6.5 V, V _{ON/OFF} = 0 V	–0.1	–	0.1	μA	4	
Ripple rejection	RR	V _{IN} = V _{OUT(S)} + 1.0 V, f = 1.0 kHz, ΔV _{rip} = 0.5 V _{rms} , I _{OUT} = 30 mA	–	70	–	dB	5	
Short-circuit current	I _{short}	V _{IN} = V _{OUT(S)} + 1.0 V, ON/OFF pin = ON, V _{OUT} = 0 V	–	160	–	mA	2	

Table 26 (2 / 2)

Detector block

(Ta = 25°C unless otherwise specified)

Item	Symbol	Conditions	Min.	Typ.	Max.	Unit	Test Circuit	
Detection voltage*5	-V _{DET}	-	-V _{DET(S)} × 0.99	-V _{DET(S)}	-V _{DET(S)} × 1.01	V	6	
Hysteresis width	V _{HYS}	-	3	5	7	%	6	
Output current	I _{DOUT}	Nch, V _{DOUT} = 0.5 V	V _{IN} = 1.4 V (1.5 V ≤ -V _{DET(S)} ≤ 5.5 V)	1.0	3.0	-	mA	7
			V _{IN} = 2.0 V (2.1 V ≤ -V _{DET(S)} ≤ 5.5 V)	2.0	4.5	-	mA	7
			V _{IN} = 3.0 V (3.1 V ≤ -V _{DET(S)} ≤ 5.5 V)	3.0	5.5	-	mA	7
			V _{IN} = 4.0 V (4.1 V ≤ -V _{DET(S)} ≤ 5.5 V)	4.0	6.0	-	mA	7
			V _{IN} = 5.0 V (5.1 V ≤ -V _{DET(S)} ≤ 5.5 V)	5.0	6.5	-	mA	7
Detection voltage temperature coefficient*6	$\frac{\Delta - V_{DET}}{\Delta T_a \bullet -V_{DET}}$	-40°C ≤ Ta ≤ +85°C*8	-	±140	±550	ppm/°C	6	
Delay time	t _D	No delay (t _D = 60 μs)	-	60	100	μs	6	
		t _D = 50 ms	t _D × 0.65	t _D	t _D × 1.35	ms	6	
		t _D = 100 ms	t _D × 0.65	t _D	t _D × 1.35	ms	6	
Current consumption during operation	I _{SSD}	V _{IN} = V _{OUT(S)} + 1.0 V, ON/OFF pin = OFF, no load	-	5	7	μA	8	
Input voltage	V _{IN}	-	0.8	-	6.5	V	-	
Current leakage of output transistor	I _{LEAK}	V _{IN} = 6.5 V, V _{DOUT} = 6.5 V	-	-	0.1	μA	7	

- *1. V_{OUT(S)}: Specified output voltage
V_{OUT(E)}: Actual output voltage at the fixed load
The output voltage when fixing I_{OUT} (= 30 mA) and inputting V_{OUT(S)} + 1.0 V
- *2. The output current at which the output voltage becomes lower than 95% of V_{OUT(E)} after gradually increasing the output current.
- *3. V_{drop} = V_{IN1} - (V_{OUT3} × 0.98)
V_{OUT3} is the output voltage when V_{IN} = V_{OUT(S)} + 1.0 V and I_{OUT} = 100 mA.
V_{IN1} is the input voltage at which the output voltage becomes 98% of V_{OUT3} after gradually decreasing the input voltage.
- *4. The change in temperature [mV/°C] of the regulator output voltage is calculated using the following equation.

$$\frac{\Delta V_{OUT}}{\Delta T_a} [mV/°C]^*1 = V_{OUT(S)} [V]^*2 \times \frac{\Delta V_{OUT}}{\Delta T_a \bullet V_{OUT}} [ppm/°C]^*3 \div 1000$$
*1. The change in temperature of the output voltage
*2. Specified output voltage
*3. Output voltage temperature coefficient
- *5. -V_{DET}: Actual detection voltage, -V_{DET(S)}: Specified detection voltage
- *6. The change in temperature [mV/°C] of the detector detection voltage is calculated using the following equation.

$$\frac{\Delta - V_{DET}}{\Delta T_a} [mV/°C]^*1 = -V_{DET(S)} (typ.) [V]^*2 \times \frac{\Delta - V_{DET}}{\Delta T_a \bullet -V_{DET}} [ppm/°C]^*3 \div 1000$$
*1. The change in temperature of the detection voltage
*2. Specified detection voltage
*3. Detection voltage temperature coefficient
- *7. The output current can be at least this value.
Due to restrictions on the package power dissipation, this value may not be satisfied. Attention should be paid to the power dissipation of the package when the output current is large. This specification is guaranteed by design.
- *8. Since products are not screened at high and low temperatures, the specification for this temperature range is guaranteed by design, not tested in production.

HIGH RIPPLE-REJECTION LOW DROPOUT CMOS VOLTAGE REGULATOR WITH RESET FUNCTION

Rev.3.0_00 S-1701 Series

2. S-1701 Series D/E/F/K/L/M types

Table 27 (1 / 2)

(Ta = 25°C unless otherwise specified)

Item	Symbol	Conditions	Min.	Typ.	Max.	Unit	Test Circuit
Current consumption	I _{SS}	V _{IN} = V _{OUT(S)} + 1.0 V, no load	–	85	110	μA	3

Regulator block

Item	Symbol	Conditions	Min.	Typ.	Max.	Unit	Test Circuit	
Output voltage* ¹	V _{OUT(E)}	V _{IN} = V _{OUT(S)} + 1.0 V, I _{OUT} = 30 mA	V _{OUT(S)} × 0.99	V _{OUT(S)}	V _{OUT(S)} × 1.01	V	1	
Output current* ²	I _{OUT}	V _{IN} ≥ V _{OUT(S)} + 2.0 V When V _{OUT(S)} = 4.5 V or higher, V _{IN} = 6.5 V	400* ⁷	–	–	mA	2	
Dropout voltage* ³	V _{drop}	I _{OUT} = 100 mA	1.5 V ≤ V _{OUT(S)} ≤ 1.6 V	0.50	0.54	0.58	V	1
			1.7 V ≤ V _{OUT(S)} ≤ 1.8 V	–	0.34	0.38	V	1
			1.9 V ≤ V _{OUT(S)} ≤ 2.3 V	–	0.19	0.29	V	1
			2.4 V ≤ V _{OUT(S)} ≤ 2.7 V	–	0.16	0.25	V	1
			2.8 V ≤ V _{OUT(S)} ≤ 5.0 V	–	0.14	0.21	V	1
Line regulation	$\frac{\Delta V_{OUT1}}{\Delta V_{IN} \cdot V_{OUT}}$	V _{OUT(S)} + 0.5 V ≤ V _{IN} ≤ 6.5 V, I _{OUT} = 30 mA	–	0.05	0.2	%/V	1	
Load regulation	ΔV _{OUT2}	V _{IN} = V _{OUT(S)} + 1.0 V, 1.0 mA ≤ I _{OUT} ≤ 100 mA	–	20	40	mV	1	
Output voltage temperature coefficient* ⁴	$\frac{\Delta V_{OUT}}{\Delta T_a \cdot V_{OUT}}$	V _{IN} = V _{OUT(S)} + 1.0 V, I _{OUT} = 30 mA –40°C ≤ Ta ≤ +85°C* ⁸	–	±100	±350	ppm/°C	1	
Current consumption during operation	I _{SSR}	V _{IN} = V _{OUT(S)} + 1.0 V, ON/OFF pin = ON, no load	–	80	103	μA	3	
Input voltage	V _{IN}	–	2	–	6.5	V	–	
ON/OFF pin input voltage “H”	V _{SH}	V _{IN} = V _{OUT(S)} + 1.0 V, R _L = 1.0 kΩ	1.5	–	–	V	4	
ON/OFF pin input voltage “L”	V _{SL}	V _{IN} = V _{OUT(S)} + 1.0 V, R _L = 1.0 kΩ	–	–	0.3	V	4	
ON/OFF pin input current “H”	I _{SH}	V _{IN} = 6.5 V, V _{ON/OFF} = 6.5 V	–0.1	–	0.1	μA	4	
ON/OFF pin input current “L”	I _{SL}	V _{IN} = 6.5 V, V _{ON/OFF} = 0 V	–0.1	–	0.1	μA	4	
Ripple rejection	RR	V _{IN} = V _{OUT(S)} + 1.0 V, f = 1.0 kHz, ΔV _{rip} = 0.5 V _{rms} , I _{OUT} = 30 mA	–	70	–	dB	5	
Short-circuit current	I _{short}	V _{IN} = V _{OUT(S)} + 1.0 V, ON/OFF pin = ON, V _{OUT} = 0 V	–	160	–	mA	2	

Table 27 (2 / 2)

Detector block

(Ta = 25°C unless otherwise specified)

Item	Symbol	Conditions	Min.	Typ.	Max.	Unit	Test Circuit	
Detection voltage*5	-V _{DET}	-	-V _{DET(S)} × 0.99	-V _{DET(S)}	-V _{DET(S)} × 1.01	V	9	
Hysteresis width	V _{HYS}	-	3	5	7	%	9	
Output current	I _{DOUT}	Nch, V _{DOUT} = 0.5 V	V _{IN} = 1.4 V (1.5 V ≤ -V _{DET(S)} ≤ 5.5 V)	1.0	3.0	-	mA	7
			V _{IN} = 2.0 V (2.1 V ≤ -V _{DET(S)} ≤ 5.5 V)	2.0	4.5	-	mA	7
			V _{IN} = 3.0 V (3.1 V ≤ -V _{DET(S)} ≤ 5.5 V)	3.0	5.5	-	mA	7
			V _{IN} = 4.0 V (4.1 V ≤ -V _{DET(S)} ≤ 5.5 V)	4.0	6.0	-	mA	7
			V _{IN} = 5.0 V (5.1 V ≤ -V _{DET(S)} ≤ 5.5 V)	5.0	6.5	-	mA	7
Detection voltage temperature coefficient*6	$\frac{\Delta - V_{DET}}{\Delta T_a \bullet -V_{DET}}$	-40°C ≤ Ta ≤ +85°C*8	-	±140	±550	ppm/°C	9	
Delay time	t _D	No delay (t _D = 60 μs)	-	60	100	μs	9	
		t _D = 50 ms	t _D × 0.65	t _D	t _D × 1.35	ms	9	
		t _D = 100 ms	t _D × 0.65	t _D	t _D × 1.35	ms	9	
Current consumption during operation	I _{SSD}	V _{IN} = V _{OUT(S)} + 1.0 V, ON/OFF pin = OFF, no load	-	5	7	μA	8	
Input voltage	V _{IN}	-	0.8	-	6.5	V	-	
Current leakage of output transistor	I _{LEAK}	V _{IN} = 6.5 V, V _{DOUT} = 6.5 V	-	-	0.1	μA	7	

- *1. V_{OUT(S)}: Specified output voltage
V_{OUT(E)}: Actual output voltage at the fixed load
The output voltage when fixing I_{OUT} (= 30 mA) and inputting V_{OUT(S)} + 1.0 V
- *2. The output current at which the output voltage becomes lower than 95% of V_{OUT(E)} after gradually increasing the output current.
- *3. V_{drop} = V_{IN1} - (V_{OUT3} × 0.98)
V_{OUT3} is the output voltage when V_{IN} = V_{OUT(S)} + 1.0 V and I_{OUT} = 100 mA.
V_{IN1} is the input voltage at which the output voltage becomes 98% of V_{OUT3} after gradually decreasing the input voltage.
- *4. The change in temperature [mV/°C] of the regulator output voltage is calculated using the following equation.

$$\frac{\Delta V_{OUT}}{\Delta T_a} [mV/°C]^*1 = V_{OUT(S)} [V]^*2 \times \frac{\Delta V_{OUT}}{\Delta T_a \bullet V_{OUT}} [ppm/°C]^*3 \div 1000$$
 - *1. The change in temperature of the output voltage
 - *2. Specified output voltage
 - *3. Output voltage temperature coefficient
- *5. -V_{DET}: Actual detection voltage, -V_{DET(S)}: Specified detection voltage
- *6. The change in temperature [mV/°C] of the detector detection voltage is calculated using the following equation.

$$\frac{\Delta - V_{DET}}{\Delta T_a} [mV/°C]^*1 = -V_{DET(S)} (typ.) [V]^*2 \times \frac{\Delta - V_{DET}}{\Delta T_a \bullet -V_{DET}} [ppm/°C]^*3 \div 1000$$
 - *1. The change in temperature of the detection voltage
 - *2. Specified detection voltage
 - *3. Detection voltage temperature coefficient
- *7. The output current can be at least this value.
Due to restrictions on the package power dissipation, this value may not be satisfied. Attention should be paid to the power dissipation of the package when the output current is large. This specification is guaranteed by design.
- *8. Since products are not screened at high and low temperatures, the specification for this temperature range is guaranteed by design, not tested in production.

HIGH RIPPLE-REJECTION LOW DROPOUT CMOS VOLTAGE REGULATOR WITH RESET FUNCTION

Rev.3.0_00 S-1701 Series

3. S-1701 Series N/P/Q types

Table 28 (1 / 2)

(Ta = 25°C unless otherwise specified)

Item	Symbol	Conditions	Min.	Typ.	Max.	Unit	Test Circuit
Current consumption	I_{SS}	$V_{IN} = V_{OUT(S)} + 1.0 \text{ V}$, no load	–	85	110	μA	12

Regulator block

Item	Symbol	Conditions	Min.	Typ.	Max.	Unit	Test Circuit	
Output voltage* ¹	$V_{OUT(E)}$	$V_{IN} = V_{OUT(S)} + 1.0 \text{ V}$, $I_{OUT} = 30 \text{ mA}$	$V_{OUT(S)} \times 0.99$	$V_{OUT(S)}$	$V_{OUT(S)} \times 1.01$	V	10	
Output current* ²	I_{OUT}	$V_{IN} \geq V_{OUT(S)} + 2.0 \text{ V}$ When $V_{OUT(S)} = 4.5 \text{ V}$ or higher, $V_{IN} = 6.5 \text{ V}$	400^{*7}	–	–	mA	11	
Dropout voltage* ³	V_{drop}	$I_{OUT} = 100 \text{ mA}$	$1.5 \text{ V} \leq V_{OUT(S)} \leq 1.6 \text{ V}$	0.50	0.54	0.58	V	10
			$1.7 \text{ V} \leq V_{OUT(S)} \leq 1.8 \text{ V}$	–	0.34	0.38	V	10
			$1.9 \text{ V} \leq V_{OUT(S)} \leq 2.3 \text{ V}$	–	0.19	0.29	V	10
			$2.4 \text{ V} \leq V_{OUT(S)} \leq 2.7 \text{ V}$	–	0.16	0.25	V	10
			$2.8 \text{ V} \leq V_{OUT(S)} \leq 5.0 \text{ V}$	–	0.14	0.21	V	10
Line regulation	$\frac{\Delta V_{OUT1}}{\Delta V_{IN} \cdot V_{OUT}}$	$V_{OUT(S)} + 0.5 \text{ V} \leq V_{IN} \leq 6.5 \text{ V}$, $I_{OUT} = 30 \text{ mA}$	–	0.05	0.2	%/V	10	
Load regulation	ΔV_{OUT2}	$V_{IN} = V_{OUT(S)} + 1.0 \text{ V}$, $1.0 \text{ mA} \leq I_{OUT} \leq 100 \text{ mA}$	–	20	40	mV	10	
Output voltage temperature coefficient* ⁴	$\frac{\Delta V_{OUT}}{\Delta T_a \cdot V_{OUT}}$	$V_{IN} = V_{OUT(S)} + 1.0 \text{ V}$, $I_{OUT} = 30 \text{ mA}$ $-40^\circ\text{C} \leq T_a \leq +85^\circ\text{C}^{*8}$	–	± 100	± 350	ppm/°C	10	
Input voltage	V_{IN}	–	2	–	6.5	V	–	
Ripple rejection	$ RR $	$V_{IN} = V_{OUT(S)} + 1.0 \text{ V}$, $f = 1.0 \text{ kHz}$, $\Delta V_{rip} = 0.5 \text{ V}_{rms}$, $I_{OUT} = 30 \text{ mA}$	–	70	–	dB	13	
Short-circuit current	I_{short}	$V_{IN} = V_{OUT(S)} + 1.0 \text{ V}$, $V_{OUT} = 0 \text{ V}$	–	160	–	mA	11	

Table 28 (2 / 2)

Detector block

(Ta = 25°C unless otherwise specified)

Item	Symbol	Conditions	Min.	Typ.	Max.	Unit	Test Circuit	
Detection voltage*5	-V _{DET}	-	-V _{DET(S)} × 0.99	-V _{DET(S)}	-V _{DET(S)} × 1.01	V	14	
Hysteresis width	V _{HYS}	-	3	5	7	%	14	
Output current	I _{DOUT}	Nch, V _{DOUT} = 0.5 V	V _{IN} = 1.4 V (1.5 V ≤ -V _{DET(S)} ≤ 5.5 V)	1.0	3.0	-	mA	15
			V _{IN} = 2.0 V (2.1 V ≤ -V _{DET(S)} ≤ 5.5 V)	2.0	4.5	-	mA	15
			V _{IN} = 3.0 V (3.1 V ≤ -V _{DET(S)} ≤ 5.5 V)	3.0	5.5	-	mA	15
			V _{IN} = 4.0 V (4.1 V ≤ -V _{DET(S)} ≤ 5.5 V)	4.0	6.0	-	mA	15
			V _{IN} = 5.0 V (5.1 V ≤ -V _{DET(S)} ≤ 5.5 V)	5.0	6.5	-	mA	15
Detection voltage temperature coefficient*6	$\frac{\Delta - V_{DET}}{\Delta Ta \bullet -V_{DET}}$	-40°C ≤ Ta ≤ +85°C*8	-	±140	±550	ppm/°C	14	
Delay time	t _D	No delay (t _D = 60 μs)	-	60	100	μs	14	
		t _D = 50 ms	t _D × 0.65	t _D	t _D × 1.35	ms	14	
		t _D = 100 ms	t _D × 0.65	t _D	t _D × 1.35	ms	14	
Input voltage	V _{IN}	-	0.8	-	6.5	V	-	
Current leakage of output transistor	I _{LEAK}	V _{IN} = 6.5 V, V _{DOUT} = 6.5 V	-	-	0.1	μA	15	

- *1. V_{OUT(S)}: Specified output voltage
 V_{OUT(E)}: Actual output voltage at the fixed load
 The output voltage when fixing I_{OUT} (= 30 mA) and inputting V_{OUT(S)} + 1.0 V
- *2. The output current at which the output voltage becomes lower than 95% of V_{OUT(E)} after gradually increasing the output current.
- *3. V_{drop} = V_{IN1} - (V_{OUT3} × 0.98)
 V_{OUT3} is the output voltage when V_{IN} = V_{OUT(S)} + 1.0 V and I_{OUT} = 100 mA.
 V_{IN1} is the input voltage at which the output voltage becomes 98% of V_{OUT3} after gradually decreasing the input voltage.
- *4. The change in temperature [mV/°C] of the regulator output voltage is calculated using the following equation.

$$\frac{\Delta V_{OUT}}{\Delta Ta} [mV/°C]^*1 = V_{OUT(S)} [V]^*2 \times \frac{\Delta V_{OUT}}{\Delta Ta \bullet V_{OUT}} [ppm/°C]^*3 \div 1000$$
 - *1. The change in temperature of the output voltage
 - *2. Specified output voltage
 - *3. Output voltage temperature coefficient
- *5. -V_{DET}: Actual detection voltage, -V_{DET(S)}: Specified detection voltage
- *6. The change in temperature [mV/°C] of the detector detection voltage is calculated using the following equation.

$$\frac{\Delta - V_{DET}}{\Delta Ta} [mV/°C]^*1 = -V_{DET(S)} (typ.) [V]^*2 \times \frac{\Delta - V_{DET}}{\Delta Ta \bullet -V_{DET}} [ppm/°C]^*3 \div 1000$$
 - *1. The change in temperature of the detection voltage
 - *2. Specified detection voltage
 - *3. Detection voltage temperature coefficient
- *7. The output current can be at least this value.
 Due to restrictions on the package power dissipation, this value may not be satisfied. Attention should be paid to the power dissipation of the package when the output current is large. This specification is guaranteed by design.
- *8. Since products are not screened at high and low temperatures, the specification for this temperature range is guaranteed by design, not tested in production.

HIGH RIPPLE-REJECTION LOW DROPOUT CMOS VOLTAGE REGULATOR WITH RESET FUNCTION
Rev.3.0_00 **S-1701 Series**

4. S-1701 Series R/S/T types

Table 29 (1 / 2)

(Ta = 25°C unless otherwise specified)

Item	Symbol	Conditions	Min.	Typ.	Max.	Unit	Test Circuit
Current consumption	I _{SS}	V _{IN} = V _{OUT(S)} + 1.0 V, no load	–	85	110	μA	12

Regulator block

Item	Symbol	Conditions	Min.	Typ.	Max.	Unit	Test Circuit	
Output voltage* ¹	V _{OUT(E)}	V _{IN} = V _{OUT(S)} + 1.0 V, I _{OUT} = 30 mA	V _{OUT(S)} × 0.99	V _{OUT(S)}	V _{OUT(S)} × 1.01	V	10	
Output current* ²	I _{OUT}	V _{IN} ≥ V _{OUT(S)} + 2.0 V When V _{OUT(S)} = 4.5 V or higher, V _{IN} = 6.5 V	400* ⁷	–	–	mA	11	
Dropout voltage* ³	V _{drop}	I _{OUT} = 100 mA	1.5 V ≤ V _{OUT(S)} ≤ 1.6 V	0.50	0.54	0.58	V	10
			1.7 V ≤ V _{OUT(S)} ≤ 1.8 V	–	0.34	0.38	V	10
			1.9 V ≤ V _{OUT(S)} ≤ 2.3 V	–	0.19	0.29	V	10
			2.4 V ≤ V _{OUT(S)} ≤ 2.7 V	–	0.16	0.25	V	10
			2.8 V ≤ V _{OUT(S)} ≤ 5.0 V	–	0.14	0.21	V	10
Line regulation	$\frac{\Delta V_{OUT1}}{\Delta V_{IN} \cdot V_{OUT}}$	V _{OUT(S)} + 0.5 V ≤ V _{IN} ≤ 6.5 V, I _{OUT} = 30 mA	–	0.05	0.2	%/V	10	
Load regulation	ΔV _{OUT2}	V _{IN} = V _{OUT(S)} + 1.0 V, 1.0 mA ≤ I _{OUT} ≤ 100 mA	–	20	40	mV	10	
Output voltage temperature coefficient* ⁴	$\frac{\Delta V_{OUT}}{\Delta T_a \cdot V_{OUT}}$	V _{IN} = V _{OUT(S)} + 1.0 V, I _{OUT} = 30 mA –40°C ≤ Ta ≤ +85°C* ⁸	–	±100	±350	ppm/°C	10	
Input voltage	V _{IN}	–	2	–	6.5	V	–	
Ripple rejection	RR	V _{IN} = V _{OUT(S)} + 1.0 V, f = 1.0 kHz, ΔV _{rip} = 0.5 V _{rms} , I _{OUT} = 30 mA	–	70	–	dB	13	
Short-circuit current	I _{short}	V _{IN} = V _{OUT(S)} + 1.0 V, V _{OUT} = 0 V	–	160	–	mA	11	

Table 29 (2 / 2)

Detector block

(Ta = 25°C unless otherwise specified)

Item	Symbol	Conditions	Min.	Typ.	Max.	Unit	Test Circuit	
Detection voltage*5	-V _{DET}	-	-V _{DET(S)} × 0.99	-V _{DET(S)}	-V _{DET(S)} × 1.01	V	14	
Hysteresis width	V _{HYS}	-	3	5	7	%	14	
Output current	I _{DOUT}	Nch, V _{DOUT} = 0.5 V	V _{IN} = 1.4 V (1.5 V ≤ -V _{DET(S)} ≤ 5.5 V)	1.0	3.0	-	mA	15
			V _{IN} = 2.0 V (2.1 V ≤ -V _{DET(S)} ≤ 5.5 V)	2.0	4.5	-	mA	15
			V _{IN} = 3.0 V (3.1 V ≤ -V _{DET(S)} ≤ 5.5 V)	3.0	5.5	-	mA	15
			V _{IN} = 4.0 V (4.1 V ≤ -V _{DET(S)} ≤ 5.5 V)	4.0	6.0	-	mA	15
			V _{IN} = 5.0 V (5.1 V ≤ -V _{DET(S)} ≤ 5.5 V)	5.0	6.5	-	mA	15
Detection voltage temperature coefficient*6	$\frac{\Delta - V_{DET}}{\Delta Ta \bullet -V_{DET}}$	-40°C ≤ Ta ≤ +85°C*8	-	±140	±550	ppm/°C	14	
Delay time	t _D	No delay (t _D = 60 μs)	-	60	100	μs	14	
		t _D = 50 ms	t _D × 0.65	t _D	t _D × 1.35	ms	14	
		t _D = 100 ms	t _D × 0.65	t _D	t _D × 1.35	ms	14	
Input voltage	V _{IN}	-	0.8	-	6.5	V	-	
Current leakage of output transistor	I _{LEAK}	V _{IN} = 6.5 V, V _{DOUT} = 6.5 V	-	-	0.1	μA	15	

- *1. V_{OUT(S)}: Specified output voltage
 V_{OUT(E)}: Actual output voltage at the fixed load
 The output voltage when fixing I_{OUT} (= 30 mA) and inputting V_{OUT(S)} + 1.0 V
- *2. The output current at which the output voltage becomes lower than 95% of V_{OUT(E)} after gradually increasing the output current.
- *3. V_{drop} = V_{IN1} - (V_{OUT3} × 0.98)
 V_{OUT3} is the output voltage when V_{IN} = V_{OUT(S)} + 1.0 V and I_{OUT} = 100 mA.
 V_{IN1} is the input voltage at which the output voltage becomes 98% of V_{OUT3} after gradually decreasing the input voltage.
- *4. The change in temperature [mV/°C] of the regulator output voltage is calculated using the following equation.

$$\frac{\Delta V_{OUT}}{\Delta Ta} [mV/°C]^*1 = V_{OUT(S)} [V]^*2 \times \frac{\Delta V_{OUT}}{\Delta Ta \bullet V_{OUT}} [ppm/°C]^*3 \div 1000$$
 - *1. The change in temperature of the output voltage
 - *2. Specified output voltage
 - *3. Output voltage temperature coefficient
- *5. -V_{DET}: Actual detection voltage, -V_{DET(S)}: Specified detection voltage
- *6. The change in temperature [mV/°C] of the detector detection voltage is calculated using the following equation.

$$\frac{\Delta - V_{DET}}{\Delta Ta} [mV/°C]^*1 = -V_{DET(S)} (typ.) [V]^*2 \times \frac{\Delta - V_{DET}}{\Delta Ta \bullet -V_{DET}} [ppm/°C]^*3 \div 1000$$
 - *1. The change in temperature of the detection voltage
 - *2. Specified detection voltage
 - *3. Detection voltage temperature coefficient
- *7. The output current can be at least this value.
 Due to restrictions on the package power dissipation, this value may not be satisfied. Attention should be paid to the power dissipation of the package when the output current is large. This specification is guaranteed by design.
- *8. Since products are not screened at high and low temperatures, the specification for this temperature range is guaranteed by design, not tested in production.

HIGH RIPPLE-REJECTION LOW DROPOUT CMOS VOLTAGE REGULATOR WITH RESET FUNCTION

Rev.3.0_00 S-1701 Series

5. S-1701 Series U/V/W types

Table 30 (1 / 2)

(Ta = 25°C unless otherwise specified)

Item	Symbol	Conditions	Min.	Typ.	Max.	Unit	Test Circuit
Current consumption	I _{SS}	V _{IN} = V _{OUT(S)} + 1.0 V, no load	–	85	110	μA	12

Regulator block

Item	Symbol	Conditions	Min.	Typ.	Max.	Unit	Test Circuit	
Output voltage* ¹	V _{OUT(E)}	V _{IN} = V _{OUT(S)} + 1.0 V, I _{OUT} = 30 mA	V _{OUT(S)} × 0.99	V _{OUT(S)}	V _{OUT(S)} × 1.01	V	10	
Output current* ²	I _{OUT}	V _{IN} ≥ V _{OUT(S)} + 2.0 V When V _{OUT(S)} = 4.5 V or higher, V _{IN} = 6.5 V	400* ⁷	–	–	mA	11	
Dropout voltage* ³	V _{drop}	I _{OUT} = 100 mA	1.5 V ≤ V _{OUT(S)} ≤ 1.6 V	0.50	0.54	0.58	V	10
			1.7 V ≤ V _{OUT(S)} ≤ 1.8 V	–	0.34	0.38	V	10
			1.9 V ≤ V _{OUT(S)} ≤ 2.3 V	–	0.19	0.29	V	10
			2.4 V ≤ V _{OUT(S)} ≤ 2.7 V	–	0.16	0.25	V	10
			2.8 V ≤ V _{OUT(S)} ≤ 5.0 V	–	0.14	0.21	V	10
Line regulation	$\frac{\Delta V_{OUT1}}{\Delta V_{IN} \cdot V_{OUT}}$	V _{OUT(S)} + 0.5 V ≤ V _{IN} ≤ 6.5 V, I _{OUT} = 30 mA	–	0.05	0.2	%/V	10	
Load regulation	ΔV _{OUT2}	V _{IN} = V _{OUT(S)} + 1.0 V, 1.0 mA ≤ I _{OUT} ≤ 100 mA	–	20	40	mV	10	
Output voltage temperature coefficient* ⁴	$\frac{\Delta V_{OUT}}{\Delta T_a \cdot V_{OUT}}$	V _{IN} = V _{OUT(S)} + 1.0 V, I _{OUT} = 30 mA –40°C ≤ Ta ≤ +85°C* ⁸	–	±100	±350	ppm/°C	10	
Input voltage	V _{IN}	–	2	–	6.5	V	–	
Ripple rejection	RR	V _{IN} = V _{OUT(S)} + 1.0 V, f = 1.0 kHz, ΔV _{rip} = 0.5 V _{rms} , I _{OUT} = 30 mA	–	70	–	dB	13	
Short-circuit current	I _{short}	V _{IN} = V _{OUT(S)} + 1.0 V, V _{OUT} = 0 V	–	160	–	mA	11	

Table 30 (2 / 2)

Detector block

(Ta = 25°C unless otherwise specified)

Item	Symbol	Conditions	Min.	Typ.	Max.	Unit	Test Circuit	
Detection voltage*5	-V _{DET}	-	$-V_{DET(S)} \times 0.99$	-V _{DET(S)}	$-V_{DET(S)} \times 1.01$	V	16	
Hysteresis width	V _{HYS}	-	3	5	7	%	16	
Output current	I _{DOUT}	Nch, V _{DOUT} = 0.5 V	V _{IN} = 1.4 V (1.5 V ≤ -V _{DET(S)} ≤ 5.5 V)	1.0	3.0	-	mA	15
			V _{IN} = 2.0 V (2.1 V ≤ -V _{DET(S)} ≤ 5.5 V)	2.0	4.5	-	mA	15
			V _{IN} = 3.0 V (3.1 V ≤ -V _{DET(S)} ≤ 5.5 V)	3.0	5.5	-	mA	15
			V _{IN} = 4.0 V (4.1 V ≤ -V _{DET(S)} ≤ 5.5 V)	4.0	6.0	-	mA	15
			V _{IN} = 5.0 V (5.1 V ≤ -V _{DET(S)} ≤ 5.5 V)	5.0	6.5	-	mA	15
Detection voltage temperature coefficient*6	$\frac{\Delta - V_{DET}}{\Delta Ta \bullet -V_{DET}}$	-40°C ≤ Ta ≤ +85°C*8	-	±140	±550	ppm/°C	16	
Delay time	t _D	No delay (t _D = 60 μs)	-	60	100	μs	16	
		t _D = 50 ms	t _D × 0.65	t _D	t _D × 1.35	ms	16	
		t _D = 100 ms	t _D × 0.65	t _D	t _D × 1.35	ms	16	
Input voltage	V _{IN}	-	0.8	-	6.5	V	-	
Current leakage of output transistor	I _{LEAK}	V _{IN} = 6.5 V, V _{DOUT} = 6.5 V	-	-	0.1	μA	15	

- *1. V_{OUT(S)}: Specified output voltage
V_{OUT(E)}: Actual output voltage at the fixed load
The output voltage when fixing I_{OUT} (= 30 mA) and inputting V_{OUT(S)} + 1.0 V
- *2. The output current at which the output voltage becomes lower than 95% of V_{OUT(E)} after gradually increasing the output current.
- *3. V_{drop} = V_{IN1} - (V_{OUT3} × 0.98)
V_{OUT3} is the output voltage when V_{IN} = V_{OUT(S)} + 1.0 V and I_{OUT} = 100 mA.
V_{IN1} is the input voltage at which the output voltage becomes 98% of V_{OUT3} after gradually decreasing the input voltage.
- *4. The change in temperature [mV/°C] of the regulator output voltage is calculated using the following equation.

$$\frac{\Delta V_{OUT}}{\Delta Ta} [mV/°C]^*1 = V_{OUT(S)} [V]^*2 \times \frac{\Delta V_{OUT}}{\Delta Ta \bullet V_{OUT}} [ppm/°C]^*3 \div 1000$$
 - *1. The change in temperature of the output voltage
 - *2. Specified output voltage
 - *3. Output voltage temperature coefficient
- *5. -V_{DET}: Actual detection voltage, -V_{DET(S)}: Specified detection voltage
- *6. The change in temperature [mV/°C] of the detector detection voltage is calculated using the following equation.

$$\frac{\Delta - V_{DET}}{\Delta Ta} [mV/°C]^*1 = -V_{DET(S)} (typ.) [V]^*2 \times \frac{\Delta - V_{DET}}{\Delta Ta \bullet -V_{DET}} [ppm/°C]^*3 \div 1000$$
 - *1. The change in temperature of the detection voltage
 - *2. Specified detection voltage
 - *3. Detection voltage temperature coefficient
- *7. The output current can be at least this value.
Due to restrictions on the package power dissipation, this value may not be satisfied. Attention should be paid to the power dissipation of the package when the output current is large. This specification is guaranteed by design.
- *8. Since products are not screened at high and low temperatures, the specification for this temperature range is guaranteed by design, not tested in production.

HIGH RIPPLE-REJECTION LOW DROPOUT CMOS VOLTAGE REGULATOR WITH RESET FUNCTION

Rev.3.0_00 S-1701 Series

6. S-1701 Series X/Y/Z types

Table 31 (1 / 2)

(Ta = 25°C unless otherwise specified)

Item	Symbol	Conditions	Min.	Typ.	Max.	Unit	Test Circuit
Current consumption	I_{SS}	$V_{IN} = V_{OUT(S)} + 1.0 \text{ V}$, no load	–	85	110	μA	12

Regulator block

Item	Symbol	Conditions	Min.	Typ.	Max.	Unit	Test Circuit	
Output voltage* ¹	$V_{OUT(E)}$	$V_{IN} = V_{OUT(S)} + 1.0 \text{ V}$, $I_{OUT} = 30 \text{ mA}$	$V_{OUT(S)} \times 0.99$	$V_{OUT(S)}$	$V_{OUT(S)} \times 1.01$	V	10	
Output current* ²	I_{OUT}	$V_{IN} \geq V_{OUT(S)} + 2.0 \text{ V}$ When $V_{OUT(S)} = 4.5 \text{ V}$ or higher, $V_{IN} = 6.5 \text{ V}$	400^{*7}	–	–	mA	11	
Dropout voltage* ³	V_{drop}	$I_{OUT} = 100 \text{ mA}$	$1.5 \text{ V} \leq V_{OUT(S)} \leq 1.6 \text{ V}$	0.50	0.54	0.58	V	10
			$1.7 \text{ V} \leq V_{OUT(S)} \leq 1.8 \text{ V}$	–	0.34	0.38	V	10
			$1.9 \text{ V} \leq V_{OUT(S)} \leq 2.3 \text{ V}$	–	0.19	0.29	V	10
			$2.4 \text{ V} \leq V_{OUT(S)} \leq 2.7 \text{ V}$	–	0.16	0.25	V	10
			$2.8 \text{ V} \leq V_{OUT(S)} \leq 5.0 \text{ V}$	–	0.14	0.21	V	10
Line regulation	$\frac{\Delta V_{OUT1}}{\Delta V_{IN} \cdot V_{OUT}}$	$V_{OUT(S)} + 0.5 \text{ V} \leq V_{IN} \leq 6.5 \text{ V}$, $I_{OUT} = 30 \text{ mA}$	–	0.05	0.2	%/V	10	
Load regulation	ΔV_{OUT2}	$V_{IN} = V_{OUT(S)} + 1.0 \text{ V}$, $1.0 \text{ mA} \leq I_{OUT} \leq 100 \text{ mA}$	–	20	40	mV	10	
Output voltage temperature coefficient* ⁴	$\frac{\Delta V_{OUT}}{\Delta T_a \cdot V_{OUT}}$	$V_{IN} = V_{OUT(S)} + 1.0 \text{ V}$, $I_{OUT} = 30 \text{ mA}$ $-40^\circ\text{C} \leq T_a \leq +85^\circ\text{C}^{*8}$	–	± 100	± 350	ppm/°C	10	
Input voltage	V_{IN}	–	2	–	6.5	V	–	
Ripple rejection	$ RR $	$V_{IN} = V_{OUT(S)} + 1.0 \text{ V}$, $f = 1.0 \text{ kHz}$, $\Delta V_{rip} = 0.5 \text{ V}_{rms}$, $I_{OUT} = 30 \text{ mA}$	–	70	–	dB	13	
Short-circuit current	I_{short}	$V_{IN} = V_{OUT(S)} + 1.0 \text{ V}$, $V_{OUT} = 0 \text{ V}$	–	160	–	mA	11	

Table 31 (2 / 2)

Detector block

(Ta = 25°C unless otherwise specified)

Item	Symbol	Conditions	Min.	Typ.	Max.	Unit	Test Circuit	
Detection voltage*5	-V _{DET}	-	-V _{DET(S)} × 0.99	-V _{DET(S)}	-V _{DET(S)} × 1.01	V	14	
Hysteresis width	V _{HYS}	-	3	5	7	%	14	
Output current	I _{DOUT}	Nch, V _{DOUT} = 0.5 V	V _{IN} = 1.4 V (1.5 V ≤ -V _{DET(S)} ≤ 5.5 V)	1.0	3.0	-	mA	15
			V _{IN} = 2.0 V (2.1 V ≤ -V _{DET(S)} ≤ 5.5 V)	2.0	4.5	-	mA	15
			V _{IN} = 3.0 V (3.1 V ≤ -V _{DET(S)} ≤ 5.5 V)	3.0	5.5	-	mA	15
			V _{IN} = 4.0 V (4.1 V ≤ -V _{DET(S)} ≤ 5.5 V)	4.0	6.0	-	mA	15
			V _{IN} = 5.0 V (5.1 V ≤ -V _{DET(S)} ≤ 5.5 V)	5.0	6.5	-	mA	15
Detection voltage temperature coefficient*6	$\frac{\Delta - V_{DET}}{\Delta Ta \bullet -V_{DET}}$	-40°C ≤ Ta ≤ +85°C*8	-	±140	±550	ppm/°C	14	
Delay time	t _D	No delay (t _D = 60 μs)	-	60	100	μs	14	
		t _D = 50 ms	t _D × 0.65	t _D	t _D × 1.35	ms	14	
		t _D = 100 ms	t _D × 0.65	t _D	t _D × 1.35	ms	14	
Input voltage	V _{IN}	-	0.8	-	6.5	V	-	
Current leakage of output transistor	I _{LEAK}	V _{IN} = 6.5 V, V _{DOUT} = 6.5 V	-	-	0.1	μA	15	

- *1. V_{OUT(S)}: Specified output voltage
V_{OUT(E)}: Actual output voltage at the fixed load
The output voltage when fixing I_{OUT} (= 30 mA) and inputting V_{OUT(S)} + 1.0 V
- *2. The output current at which the output voltage becomes lower than 95% of V_{OUT(E)} after gradually increasing the output current.
- *3. V_{drop} = V_{IN1} - (V_{OUT3} × 0.98)
V_{OUT3} is the output voltage when V_{IN} = V_{OUT(S)} + 1.0 V and I_{OUT} = 100 mA.
V_{IN1} is the input voltage at which the output voltage becomes 98% of V_{OUT3} after gradually decreasing the input voltage.
- *4. The change in temperature [mV/°C] of the regulator output voltage is calculated using the following equation.

$$\frac{\Delta V_{OUT}}{\Delta Ta} [mV/°C]^*1 = V_{OUT(S)} [V]^*2 \times \frac{\Delta V_{OUT}}{\Delta Ta \bullet V_{OUT}} [ppm/°C]^*3 \div 1000$$
 - *1. The change in temperature of the output voltage
 - *2. Specified output voltage
 - *3. Output voltage temperature coefficient
- *5. -V_{DET}: Actual detection voltage, -V_{DET(S)}: Specified detection voltage
- *6. The change in temperature [mV/°C] of the detector detection voltage is calculated using the following equation.

$$\frac{\Delta - V_{DET}}{\Delta Ta} [mV/°C]^*1 = -V_{DET(S)} (typ.) [V]^*2 \times \frac{\Delta - V_{DET}}{\Delta Ta \bullet -V_{DET}} [ppm/°C]^*3 \div 1000$$
 - *1. The change in temperature of the detection voltage
 - *2. Specified detection voltage
 - *3. Detection voltage temperature coefficient
- *7. The output current can be at least this value.
Due to restrictions on the package power dissipation, this value may not be satisfied. Attention should be paid to the power dissipation of the package when the output current is large. This specification is guaranteed by design.
- *8. Since products are not screened at high and low temperatures, the specification for this temperature range is guaranteed by design, not tested in production.

■ Test Circuits

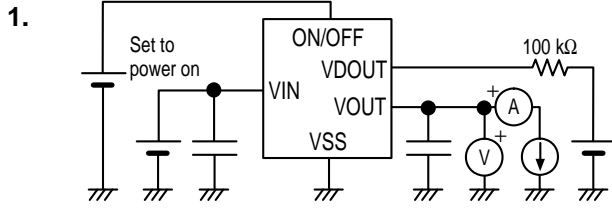

Figure 10

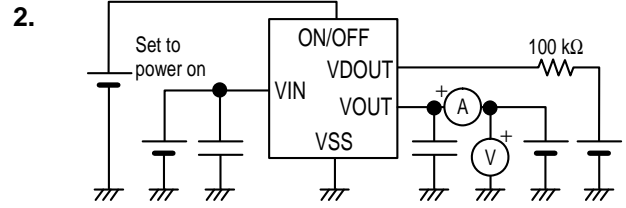

Figure 11

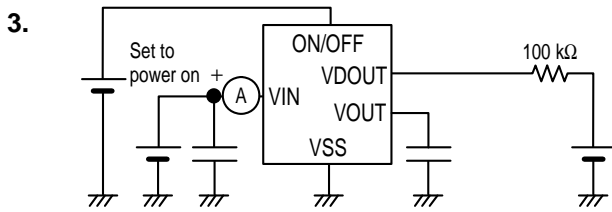

Figure 12

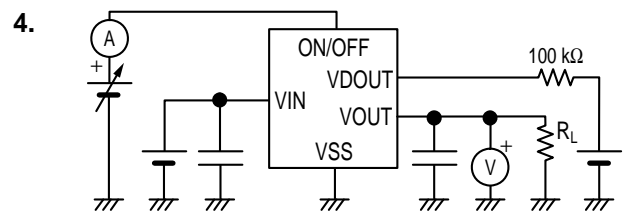

Figure 13

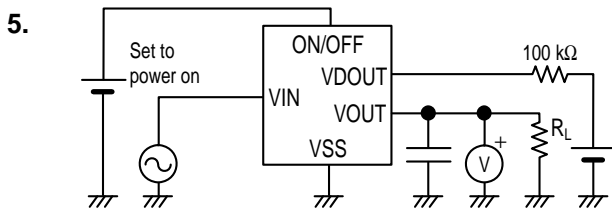

Figure 14

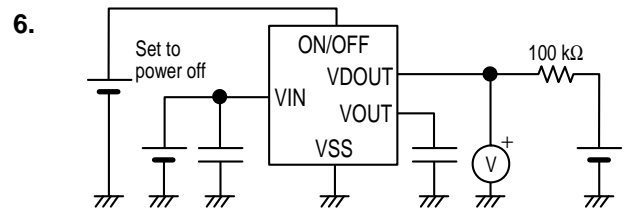

Figure 15

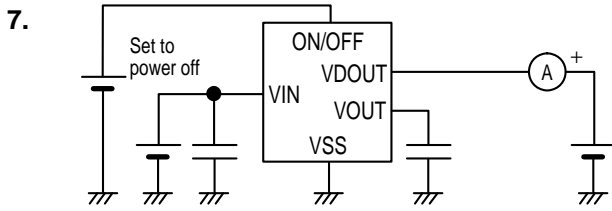

Figure 16

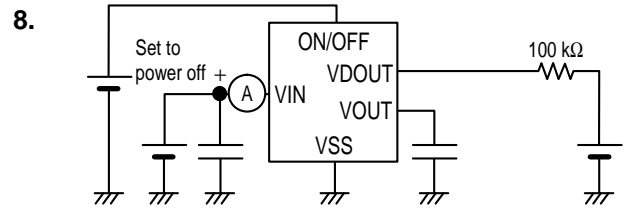

Figure 17

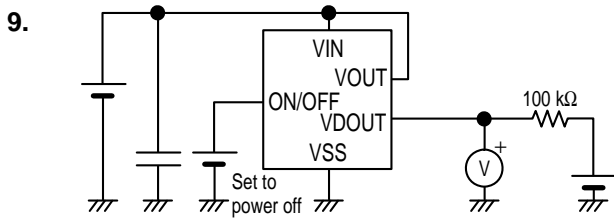

Figure 18

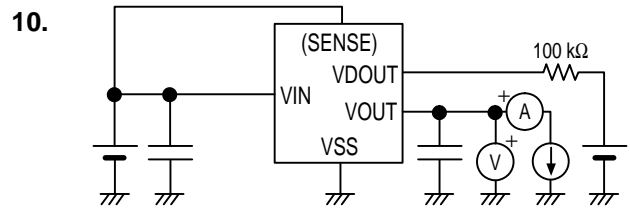

Figure 19

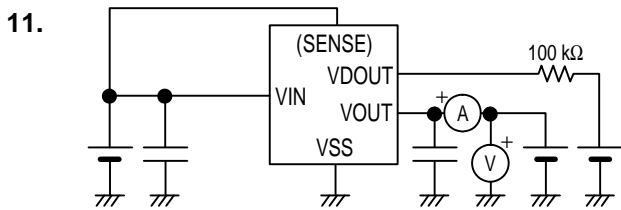

Figure 20

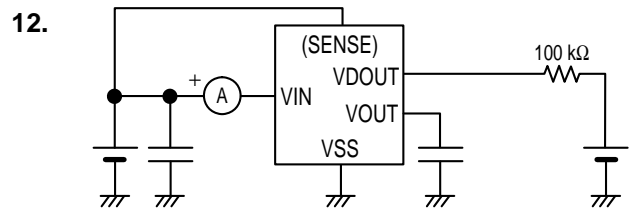

Figure 21

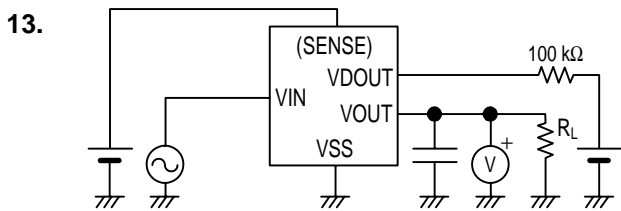

Figure 22

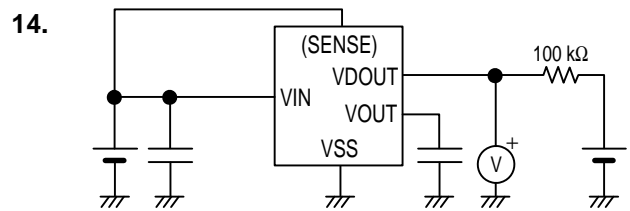

Figure 23

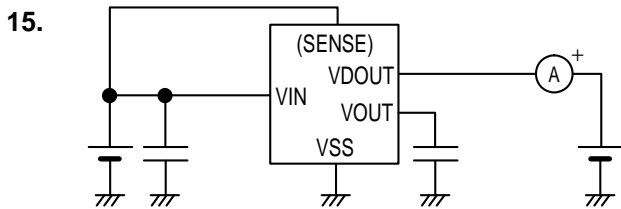

Figure 24

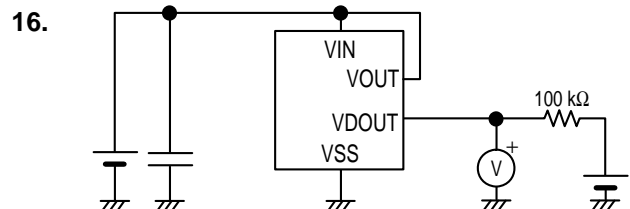
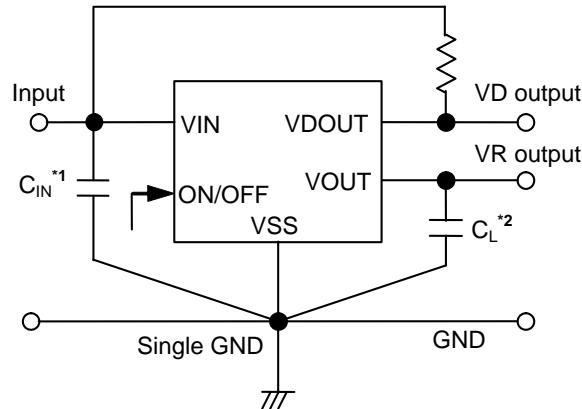

Figure 25

■ **Standard Circuit**

1. S-1701 Series A/B/C/D/E/F/G/H/J/K/L/M types



- *1. C_{IN} is a capacitor for stabilizing the input.
- *2. A ceramic capacitor of 1.0 μF or more can be used for C_L .

Figure 26

2. S-1701 Series N/P/Q/R/S/T/U/V/W/X/Y/Z types

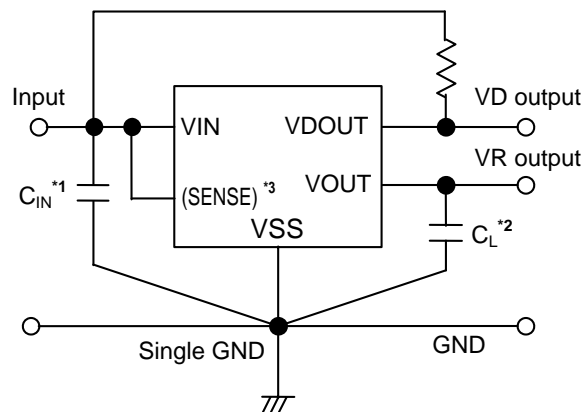

- *1. C_{IN} is a capacitor for stabilizing the input.
- *2. A ceramic capacitor of 1.0 μF or more can be used for C_L .
- *3. U/V/W/X/Y/Z types of S-1701 series are no connection.

Figure 27

Caution The above connection diagrams and constants will not guarantee successful operation. Perform thorough evaluation using the actual application to set the constants.

■ **Application Conditions**

- Input capacitor (C_{IN}): 1.0 μF or more
- Output capacitor (C_L): 1.0 μF or more
- ESR of output capacitor: 10 Ω or less

Caution A general series regulator may oscillate, depending on the external components selected. Check that no oscillation occurs in an application that uses the above capacitor.

■ Selection of Input and Output Capacitors (C_{IN} , C_L)

The S-1701 Series requires an output capacitor between the VOUT and VSS pins for phase compensation. A ceramic capacitor with a capacitance of 1.0 μ F or more provides a stable operation in all temperature ranges. When using an OS capacitor, tantalum capacitor, or aluminum electrolytic capacitor, a capacitor with a capacitance of 1.0 μ F or more and an ESR of 10 Ω or less is required.

The output overshoot and undershoot values, which are transient response characteristics, vary depending on the output capacitor value. The required capacitance value for the input capacitor differs depending on the application.

The recommended application values are $C_{IN} = 1.0 \mu\text{F}$ or more and $C_L = 1.0 \mu\text{F}$ or more, however, perform thorough evaluation using the actual device, including evaluation of temperature characteristics.

■ Explanation of Terms

Regulator block

1. Low dropout voltage regulator

The low dropout voltage regulator is a voltage regulator whose dropout voltage is low due to its built-in low on-resistance transistor.

2. Low ESR

A capacitor whose ESR (Equivalent Series Resistance) is low. The S-1701 Series enables use of a low ESR capacitor, such as a ceramic capacitor, for the output-side capacitor (C_L). A capacitor whose ESR is 10 Ω or less can be used.

3. Output voltage (V_{OUT})

The accuracy of the output voltage is ensured at $\pm 1.0\%$ under the specified conditions of fixed input voltage^{*1}, fixed output current, and fixed temperature.

*1. Differs depending on the product.

Caution If the above conditions change, the output voltage value may vary and exceed the accuracy range of the output voltage. Please see the electrical characteristics and attached characteristics data for details.

4. Line regulation $\left(\frac{\Delta V_{OUT1}}{\Delta V_{IN} \cdot V_{OUT}}\right)$

Indicates the dependency of the output voltage on the input voltage. That is, the values show how much the output voltage changes due to a change in the input voltage with the output current remaining unchanged.

5. Load regulation (ΔV_{OUT2})

Indicates the dependency of the output voltage on the output current. That is, the values show how much the output voltage changes due to a change in the output current with the input voltage remaining unchanged.

6. Dropout voltage (V_{drop})

Indicates the difference between the input voltage V_{IN1} , which is the input voltage (V_{IN}) at the point where the output voltage has fallen to 98% of the output voltage value V_{OUT3} after V_{IN} was gradually decreased from $V_{IN} = V_{OUT(S)} + 1.0$ V, and the output voltage at that point ($V_{OUT3} \times 0.98$).

$$V_{drop} = V_{IN1} - (V_{OUT3} \times 0.98)$$

7. Temperature coefficient of the output voltage $\left(\frac{\Delta V_{OUT}}{\Delta T_a \bullet V_{OUT}}\right)$

The shaded area in **Figure 28** is the range where V_{OUT} varies in the operating temperature range when the temperature coefficient of the output voltage is ± 100 ppm/ $^{\circ}\text{C}$.

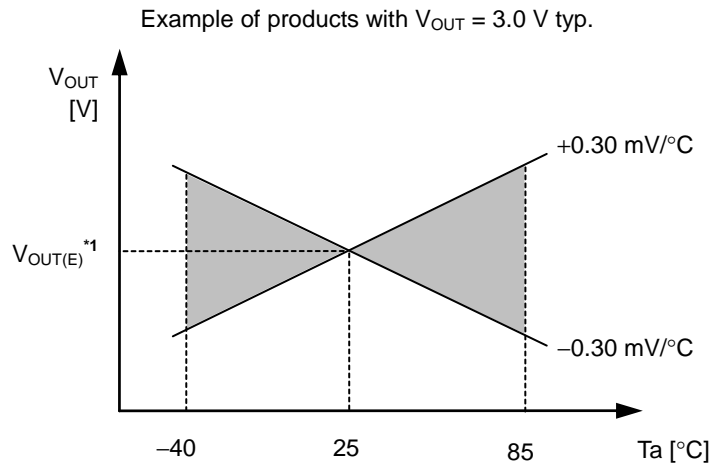

*1. $V_{OUT(E)}$ is the value of the output voltage measured at 25°C .

Figure 28

A change in the temperature of the output voltage [mV/ $^{\circ}\text{C}$] is calculated using the following equation.

$$\frac{\Delta V_{OUT}}{\Delta T_a} [\text{mV}/^{\circ}\text{C}]^{*1} = V_{OUT(S)} [\text{V}]^{*2} \times \frac{\Delta V_{OUT}}{\Delta T_a \bullet V_{OUT}} [\text{ppm}/^{\circ}\text{C}]^{*3} \div 1000$$

- *1. Change in temperature of output voltage
- *2. Specified output voltage
- *3. Output voltage temperature coefficient

Detector block

1. Detection voltage ($-V_{DET}$), Release voltage ($+V_{DET}$)

The detection voltage ($-V_{DET}$) is the voltage at which the output switches to low. The detection voltage varies slightly among products of the same specification. The variation of detection voltage between the specified minimum ($-V_{DET}$) Min. and the maximum ($-V_{DET}$) Max. is called the detection voltage range (refer to **Figure 29**).

e.g. For a product with $-V_{DET} = 3.0$ V, the detection voltage is a value in the range of 2.97 V $\leq (-V_{DET}) \leq 3.03$ V.
 This means that some products have 2.97 V for $-V_{DET}$ and some have 3.03 V.

The release voltage ($+V_{DET}$) is the voltage at which the output switches to high. The release voltage varies slightly among products of the same specification. The variation of release voltages between the specified minimum ($+V_{DET}$) Min. and the maximum ($+V_{DET}$) Max. is called the release voltage range (refer to **Figure 30**).

e.g. For a product with $-V_{DET} = 3.0$ V, the release voltage is a value in the range of 3.059 V $\leq (+V_{DET}) \leq 3.242$ V.
 This means that some products have 3.059 V for $+V_{DET}$ and some have 3.242 V.

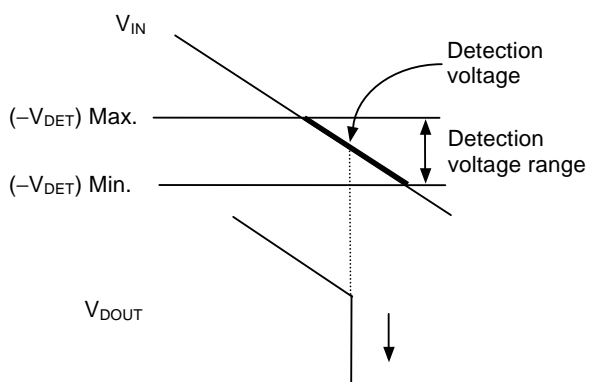

Figure 29 Detection Voltage

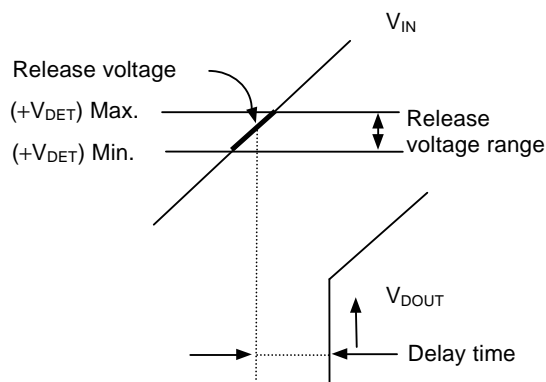

Figure 30 Release Voltage

Remark The above figures show the detection voltage and release voltage when the SENSE pin is connected to VIN.

2. Hysteresis width (V_{HYS})

The hysteresis width is the voltage difference between the detection voltage and the release voltage. The existence of the hysteresis width prevents malfunction caused by noise on the input voltage.

3. Delay time (t_D)

The delay time is a time internally measured from the instant at which the voltage input to the VDD pin exceeds the release voltage ($+V_{DET}$) to the point at which the output of the OUT pin inverts.

- S-1701 Series A/D/G/K/N/R/U/X types: No delay (60 μ s typ.)
- S-1701 Series B/E/H/L/P/S/V/Y types: 50 ms typ.
- S-1701 Series C/F/J/M/Q/T/W/Z types: 100 ms typ.

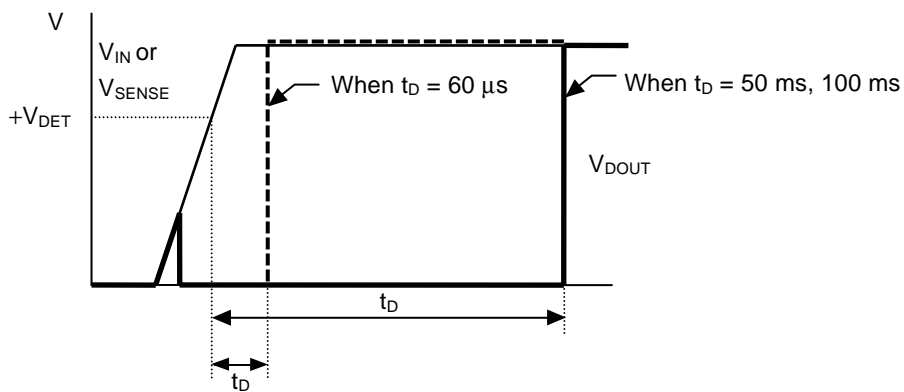

Remark The figure shows the case when the SENSE pin is connected to VIN.

Figure 31

4. Through-type current

The through-type current refers to the current that flows instantaneously when the voltage detector detects and releases a voltage. The through-type current flows at a frequency of 20 kHz during the release delay time since the internal logic circuit operates.

5. Oscillation

In applications where a resistor is connected to the input side (**Figure 32**), the through-type current which is generated when the output goes from low to high (release) causes a voltage drop equal to [through-type current] × [input resistance] across the resistor. When the input voltage drops below the detection voltage as a result, the output voltage goes from high to low. In this state, the through-type current stops, its resultant voltage drop disappears, and the output goes from low to high. The through-type current is then generated again, a voltage drop appears, and repeating the process finally induces oscillation.

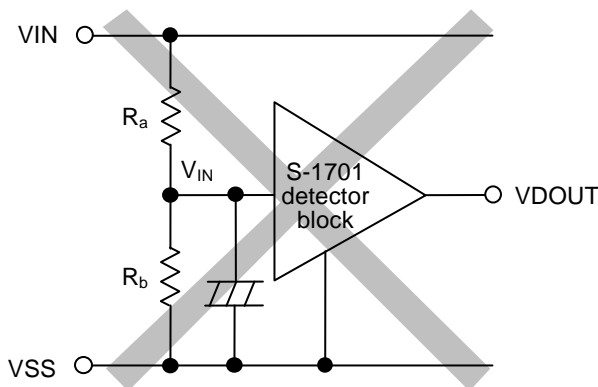

Figure 32 Example of Bad Implementation of Detection Voltage Changer

6. Other characteristics

6.1 Temperature characteristics of detection voltage

The shaded area in **Figure 33** is the range where $-V_{DET}$ varies within the operating temperature range when the temperature coefficient of the output voltage is ± 140 ppm/°C.

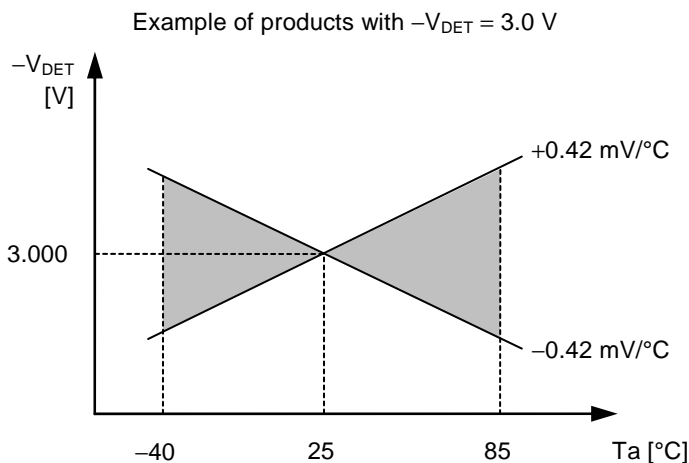

Figure 33 Detection Voltage Temperature Characteristics

6.2 Temperature characteristics of release voltage

The temperature change $\frac{\Delta+V_{DET}}{\Delta T_a}$ of the release voltage is calculated by the temperature change $\frac{\Delta-V_{DET}}{\Delta T_a}$ of the detection voltage as follows:

$$\frac{\Delta+V_{DET}}{\Delta T_a} = \frac{+V_{DET}}{-V_{DET}} \times \frac{\Delta-V_{DET}}{\Delta T_a}$$

The temperature changes of the release voltage and the detection voltage consequently have the same sign.

6.3 Temperature characteristics of hysteresis voltage

The temperature change of the hysteresis voltage is expressed as $\frac{\Delta+V_{DET}}{\Delta T_a} - \frac{\Delta-V_{DET}}{\Delta T_a}$ and is calculated as follows:

$$\frac{\Delta+V_{DET}}{\Delta T_a} - \frac{\Delta-V_{DET}}{\Delta T_a} = \frac{V_{HYS}}{-V_{DET}} \times \frac{\Delta-V_{DET}}{\Delta T_a}$$

■ **Operation**

Regulator block

1. Basic operation

Figure 34 shows the block diagram of the regulator block.

The error amplifier compares the reference voltage (V_{ref}) with V_{fb} , which is the output voltage resistance divided by feedback resistors R_s and R_f . It supplies the output transistor with the gate voltage necessary to ensure a certain output voltage free of any fluctuations of input voltage and temperature.

Output voltage is selectable from the range of 1.5 to 5.0 V in the S-1701 Series.

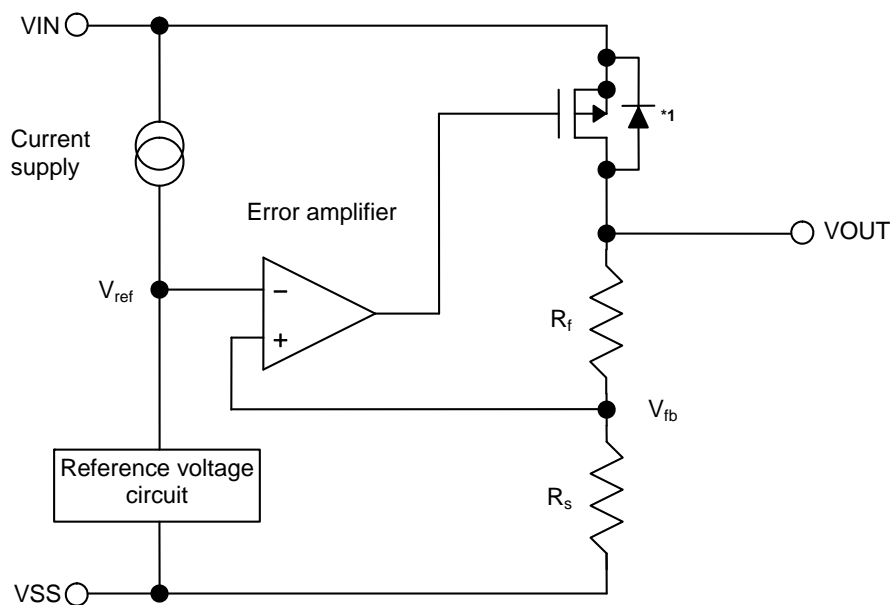

*1. Parasitic diode

Figure 34 Block Diagram (Regulator Block)

2. Output transistor

The S-1701 Series uses a low on-resistance P-channel MOS FET as the output transistor.

Be sure that V_{OUT} does not exceed $V_{IN} + 0.3$ V to prevent the voltage regulator from being damaged due to inverse current flowing from the VOUT pin through a parasitic diode to the VIN pin.

3. Shutdown pin (ON/OFF pin) (S-1701 Series A/B/C/D/E/F/G/H/J/K/L/M types)

This pin starts and stops the regulator.

When the ON/OFF pin is set to the shutdown level, the operation of all internal circuits stop, and the built-in P-channel MOS FET output transistor between the VIN pin and VOUT pin is turned off to substantially reduce the current consumption. At this time, the current consumption equals that consumed by the detector block, because the internal circuits of the detector are operating. The VOUT pin becomes the VSS level due to the internally divided resistance of several hundred kΩ between the VOUT pin and VSS pin.

The structure of the ON/OFF pin is as shown in **Figure 35**. Since the ON/OFF pin is neither pulled down nor pulled up internally, do not use it in the floating state. In addition, note that the current consumption increases if a voltage of 0.3 V to VIN – 0.3 V is applied to the ON/OFF pin. When the ON/OFF pin is not used, connect it as follows according to the product type.

- S-1701 Series A/B/C/D/E/F types: Connect to the VIN pin.
- S-1701 Series G/H/J/K/L/M types: Connect to the VSS pin.

Table 32

Product Type	ON/OFF Pin	Internal Circuits	VOUT Pin Voltage	Current Consumption
A/B/C/D/E/F	“H”: Power on	Operating	Set value	I _{SS}
A/B/C/D/E/F	“L”: Shutdown	Stopped	V _{SS} level	I _{SSD}
G/H/J/K/L/M	“H”: Shutdown	Stopped	V _{SS} level	I _{SSD}
G/H/J/K/L/M	“L”: Power on	Operating	Set value	I _{SS}

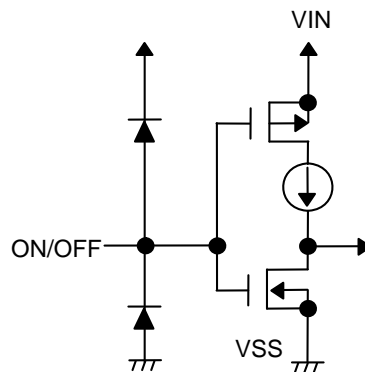
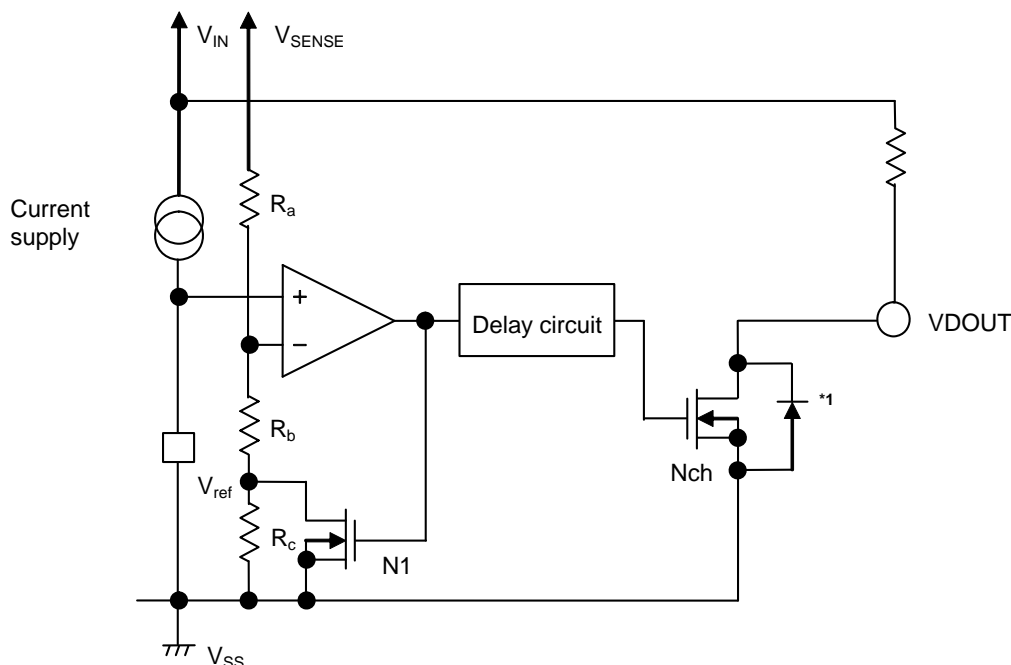

Figure 35

Detector block

1. Basic operation

Figure 36 shows a block diagram of the detector block.



*1. Parasitic diode

Figure 36 Block Diagram (Detector Block)

- (1) When the SENSE voltage (V_{SENSE}) is higher than the release voltage ($+V_{DET}$), the Nch transistor is OFF and V_{IN} (high) is output. Since the Nch transistor N1 in **Figure 36** is OFF, the comparator input voltage is $\frac{(R_b+R_c) \cdot V_{SENSE}}{R_a+R_b+R_c}$.
- (2) When V_{SENSE} goes below $+V_{DET}$, V_{IN} is output, as long as V_{SENSE} remains above the detection voltage ($-V_{DET}$). When the V_{SENSE} falls below $-V_{DET}$, the Nch transistor becomes ON and V_{SS} is output. At this time, the Nch transistor N1 in **Figure 36** becomes ON, and the comparator input voltage is changed to $\frac{R_b \cdot V_{SENSE}}{R_a+R_b}$.
- (3) When V_{IN} falls below the minimum operating voltage, the output becomes undefined. In this case the output becomes V_{IN} because it is pulled up.
- (4) V_{SS} is output when V_{IN} rises above the minimum operating voltage. The V_{SS} level still appears even when V_{SENSE} surpasses $-V_{DET}$, as long as it does not exceed the release voltage $+V_{DET}$. When V_{SENSE} rises above $+V_{DET}$, the Nch transistor becomes OFF and V_{IN} is output. V_{IN} at the VDOUT pin is delayed for t_D due to the delay circuit.
- (5) In the S-1701 Series, the detection voltage can be set within the range of 1.5 V to 5.5 V (operating voltage range: 0.8 V to 6.5 V).

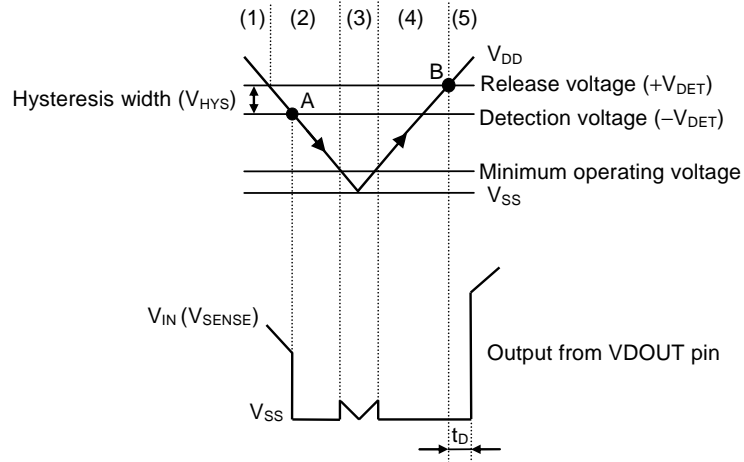

Remark The above figure shows the case when the SENSE pin is connected to VIN.

Figure 37 Operation

2. Delay circuit

The delay circuit delays the output signal from the time when the SENSE voltage (V_{SENSE}) exceeds the release voltage ($+V_{DET}$) when V_{SENSE} is turned on (refer to **point B** in **Figure 37**). The output signal is not delayed when V_{SENSE} goes below the detection voltage ($-V_{DET}$) (refer to **point A** in **Figure 37**).

The delay time (t_D) is a fixed value that is determined by a counter and a built-in clock generator which consists of constant current and a capacitor.

3. Delay circuit output voltage detection type (S-1701 Series D/E/F/K/L/M/U/W types)

If the input voltage or load current changes transiently, an undershoot or overshoot occurs in the output voltage of the regulator. In the product types in which the output voltage of the regulator is detected by the detector, if the output voltage is the detection voltage or lower due to the undershoot, the detector operates and a reset signal may be output. To prevent this, set the value of the input-and-output capacitor of a regulator so that the undershoot is the minimum value or set a voltage range that allows the difference between the output voltage and detection voltage to be equal to or greater than the undershoot.

■ Explanation for Each Type

1. S-1701 Series A/B/C types

The S-1701 Series A/B/C types provide a regulator block standby mode realized by an ON/OFF function that is active high. The internal circuit of the detector operates in the standby mode, so only the current that the detector consumes flows.

The SENSE pin is connected to the VIN pin in the internal circuit of the detector block, so the voltage applied to the VIN pin is monitored and a reset signal is output from the VDOUT pin. The built-in counter timer allows selection of the release delay time from three settings (A: No delay (60 μ s), B: 50 ms, C: 100 ms).

The power supply is shared by the regulator block and detector block and supplied from the VIN pin, so care must be taken concerning VIN pin input impedance^{*1}.

2. S-1701 Series D/E/F types

The S-1701 Series D/E/F types provide a regulator block standby mode realized by an ON/OFF function that is active high. The internal circuit of the detector operates in the standby mode, so only the current that the detector consumes flows.

The SENSE pin is connected to the VOUT pin, which is an output of the regulator, in the internal circuit of the detector block, so the output voltage of the regulator (V_{OUT}) is monitored and a reset signal is output from the VDOUT pin^{*2}. The built-in counter timer allows selection of the release delay time from three settings (D: No delay (60 μ s), E: 50 ms, F: 100 ms).

The power supply is shared by the regulator block and detector block and supplied from the VIN pin, so care must be taken concerning the VIN pin input impedance^{*1}.

3. S-1701 Series G/H/J types

The S-1701 Series G/H/J types provide a regulator block standby mode realized by an ON/OFF function that is active low. The internal circuit of the detector operates in the standby mode, so only the current that the detector consumes flows.

The SENSE pin is connected to the VIN pin in the internal circuit of the detector block, so the voltage applied to the VIN pin is monitored and a reset signal is output from the VDOUT pin. The built-in counter timer allows selection of the release delay time from three settings (G: No delay (60 μ s), H: 50 ms, J: 100 ms).

The power supply is shared by the regulator block and detector block and supplied from the VIN pin, so care must be taken concerning the VIN pin input impedance^{*1}.

4. S-1701 Series K/L/M types

The S-1701 Series K/L/M types provide a regulator block standby mode realized by an ON/OFF function that is active low. The internal circuit of the detector operates in the standby mode, so only the current that the detector consumes flows.

The SENSE pin is connected to the VOUT pin, which is an output of the regulator in the internal circuit of the detector block, so the output voltage of the regulator (V_{OUT}) is monitored and a reset signal is output from the VDOUT pin^{*2}. The built-in counter timer allows selection of the release delay time from three settings (K: No delay (60 μ s), L: 50 ms, M: 100 ms).

The power supply is shared by the regulator block and detector block and supplied from the VIN pin, so care must be taken concerning the VIN pin input impedance^{*1}.

5. S-1701 Series N/P/Q types

The S-1701 Series N/P/Q types do not provide an ON/OFF function because the ON/OFF pin is connected to the VIN pin in the circuit.

The detector block features the external SENSE pin, which allows monitoring of other power supplies. The SENSE pin is configured only by a resistor, so instantaneous current such as through-type current does not flow through this pin. This allows precise monitoring of the input power supply by connecting the SENSE pin to the input power supply even when a resistor (R_{IN}) is connected between the input power supply and the VIN pin. The built-in counter timer allows selection of the release delay time from three settings (N: No delay (60 μ s), P: 50 ms, Q: 100 ms).

The power supply is shared by the regulator block and detector block and supplied from the VIN pin, so care must be taken concerning the VIN pin input impedance^{*1}.

6. S-1701 Series R/S/T types

In the S-1701 Series R/S/T types, the VDOUT pin, which is the output pin of the detector, is connected to the ON/OFF pin of the regulator in the circuit. This allows setting of the regulator to the standby mode at the same time as the VDOUT pin outputs a RESET signal.

The detector block features an external SENSE pin, which allows monitoring of other power supplies. The SENSE pin is configured only by a resistor, so instantaneous current such as through-type current does not flow through this pin. This allows precise monitoring of the input power supply by connecting the SENSE pin to the input power supply even when a resistor (R_{IN}) is connected between the input power supply and the VIN pin. The built-in counter timer allows selection of the release delay time from three settings (R: No delay (60 μ s), S: 50 ms, T: 100 ms).

The power supply is shared by the regulator block and detector block and supplied from the VIN pin, so care must be taken concerning the VIN pin input impedance^{*1}.

7. S-1701 Series U/V/W types

The S-1701 Series U/V/W types do not provide an ON/OFF function because the ON/OFF pin is connected to the VIN pin in the circuit.

The SENSE pin is connected to the VOUT pin, which is an output pin of the regulator, in the internal circuit of the detector block, so the output voltage of the regulator (V_{OUT}) is monitored and a reset signal is output from the VDOUT pin^{*2}. The built-in counter timer allows selection of the release delay time from three settings (U: No delay (60 μ s), V: 50 ms, W: 100 ms).

The power supply is shared by the regulator block and detector block and supplied from the VIN pin, so care must be taken concerning the VIN pin input impedance^{*1}.

8. S-1701 Series X/Y/Z types

The S-1701 Series X/Y/Z types do not provide an ON/OFF function because the ON/OFF pin is connected to the VIN pin in the circuit.

The SENSE pin is connected to the VIN pin in the internal circuit of the detector block, so the voltage applied to the VIN pin is monitored and a reset signal is output from the VDOUT pin. The built-in counter timer allows selection of the release delay time from three settings (X: No delay (60 μ s), Y: 50 ms, Z: 100 ms).

The power supply is shared by the regulator block and detector block and supplied from the VIN pin, so care must be taken concerning the VIN pin input impedance^{*1}.

-
-
- *1. In S-1701 series, when connecting the resistance R_{IN} between an input power supply pin and a VIN pin, and defining the current which flows into R_{IN} as I_{IN} , VIN pin voltage falls by $\Delta V_{IN} = I_{IN} \times R_{IN}$ at the time of overload, and changes by $\Delta V_{IN} = I_{IN} \times R_{IN}$ at the time of load change. Thereby, keep in mind that phenomena, such as output voltage falls and an output oscillation, occur.

 - *2. If the input voltage or load current changes transiently, an undershoot or overshoot occurs in the output voltage of the regulator. In the product types in which the output voltage of the regulator is detected by the detector, if the output voltage is the detection voltage or lower due to the undershoot, the detector operates and a reset signal may be output. To prevent this, set the value of the input-and-output capacitor of a regulator so that the undershoot is the minimum value or set a voltage range that allows the difference between the output voltage and detection voltage to be equal to or greater than the undershoot.

■ Precautions

- Wiring patterns for the VIN, VOUT and GND pins should be designed so that the impedance is low. When mounting an output capacitor between the VOUT and VSS pins (C_L) and a capacitor for stabilizing the input between the VIN and VSS pins (C_{IN}), the distance from the capacitors to these pins should be as short as possible.
- Note that the output voltage may increase when a series regulator is used at low load current (1.0 mA or less).
- Generally, a series regulator may cause oscillation depending on the selection of external parts. The following conditions are recommended for this IC. However, be sure to perform sufficient evaluation under the actual usage conditions for selection, including evaluation of temperature characteristics.

Input capacitor (C_{IN}): 1.0 μ F or more
Output capacitor (C_L): 1.0 μ F or more
Equivalent series resistance (ESR): 10 Ω or less

- The voltage regulator may oscillate when the impedance of the power supply is high and the input capacitor is small or an input capacitor is not connected.
- The application conditions for the input voltage, output voltage, and load current should not exceed the package power dissipation.
- Do not apply an electrostatic discharge to this IC that exceeds the performance ratings of the built-in electrostatic protection circuit.
- In determining the output current, attention should be paid to the output current value specified in **Tables 26 to 31** in the electrical characteristics and footnote *7 of the table.
- SII claims no responsibility for any disputes arising out of or in connection with any infringement by products including this IC of patents owned by a third party.

■ **Application Circuit**

If the desired detection voltage range is other than those provided by the S-1701 Series, the detection voltage can be changed by using a divided resistor or diode in the SENSE pin products (N/P/Q/R/S/T types) as shown in **Figures 38** and **39**.

In the case shown in **Figure 38**, the hysteresis width also changes at the same time.

1. Changing detection voltage using divided resistors

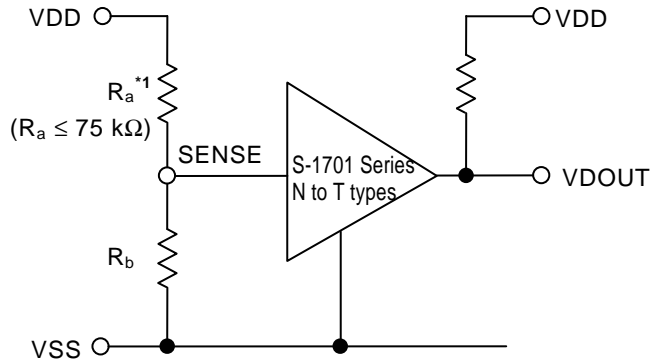

$$\text{Detection voltage} = \frac{R_a + R_b}{R_b} \cdot -V_{DET}$$

$$\text{Hysteresis width} = \frac{R_a + R_b}{R_b} \cdot V_{HYS}$$

*1. Set Ra to 75 kΩ or lower to prevent oscillation.

Figure 38

Caution If R_a and R_b are larger, the hysteresis may be greater than the result of the above formula due to the through current of the IC.

2. Changing detection voltage using diode

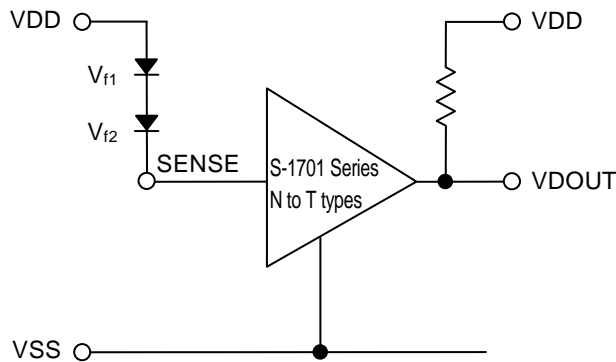

$$\text{Detection voltage} = V_{f1} + V_{f2} + (-V_{DET})$$

Figure 39

Caution The above connection diagrams (Figures 38 and 39) and constants will not guarantee successful operation. Perform thorough evaluation using the actual application to set the constants.

■ Characteristics (Typical Data)

1. Regulator block

(1) Output voltage vs. Output current (when load current increases)

S-1701x15xx ($V_{OUT} = 1.5\text{ V}$, $T_a = 25^\circ\text{C}$)

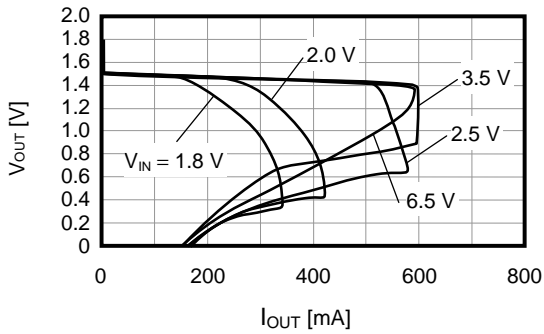

S-1701x30xx ($V_{OUT} = 3.0\text{ V}$, $T_a = 25^\circ\text{C}$)

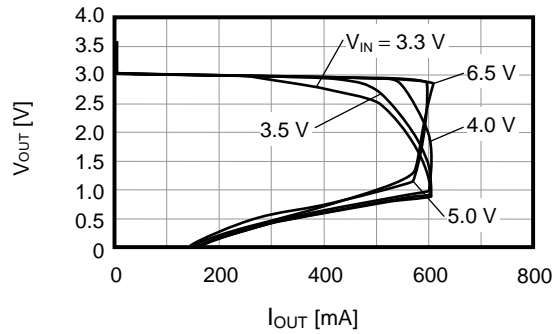

S-1701x50xx ($V_{OUT} = 5.0\text{ V}$, $T_a = 25^\circ\text{C}$)

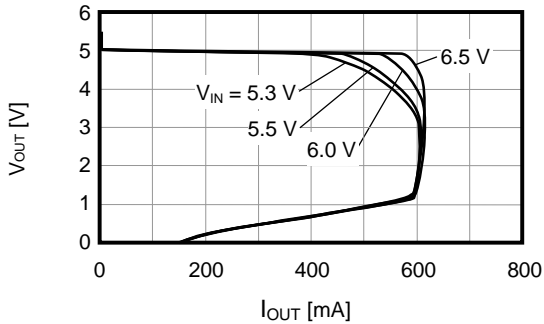

Remark In determining the output current, attention should be paid to the following.

1. The minimum output current value and footnote *7 in Table 26 to 31 in the “■ Electrical Characteristics”.
2. The package power dissipation

(2) Output voltage vs. Input voltage

S-1701x15xx ($V_{OUT} = 1.5\text{ V}$, $T_a = 25^\circ\text{C}$)

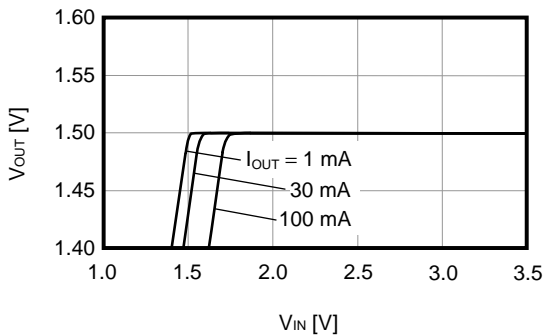

S-1701x30xx ($V_{OUT} = 3.0\text{ V}$, $T_a = 25^\circ\text{C}$)

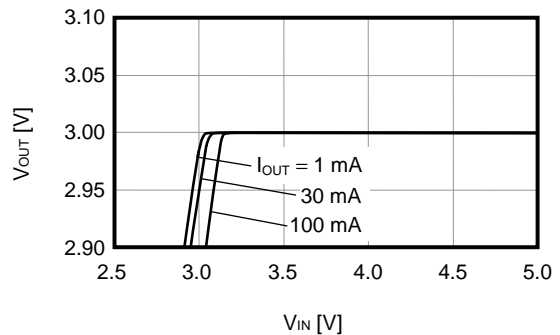

S-1701x50xx ($V_{OUT} = 5.0\text{ V}$, $T_a = 25^\circ\text{C}$)

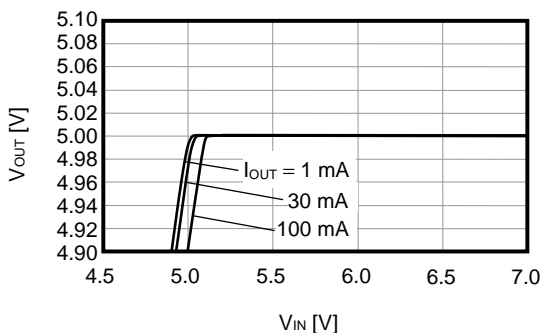

(3) Dropout voltage vs. Output current

S-1701x15xx ($V_{OUT} = 1.5\text{ V}$)

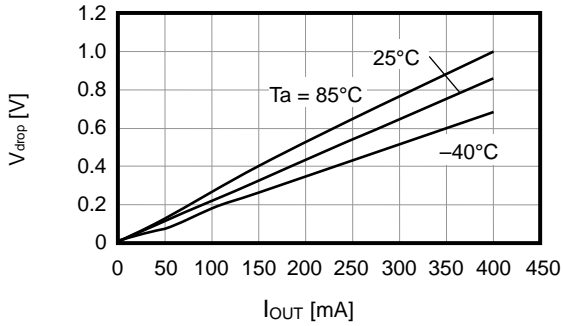

S-1701x30xx ($V_{OUT} = 3.0\text{ V}$)

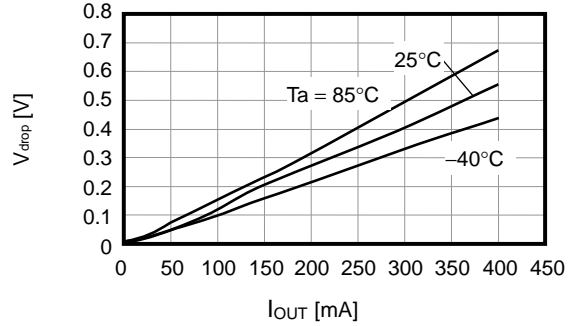

S-1701x50xx ($V_{OUT} = 5.0\text{ V}$)

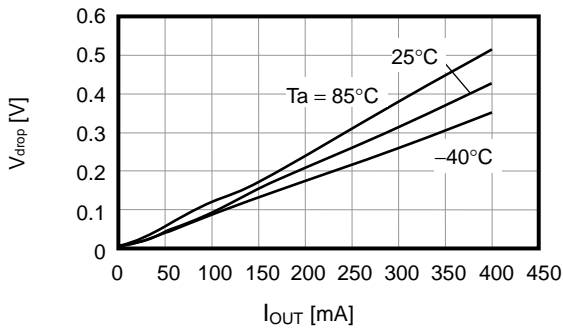

(4) Output voltage vs. Ambient temperature

S-1701x15xx ($V_{OUT} = 1.5\text{ V}$, $I_{OUT} = 30\text{ mA}$)

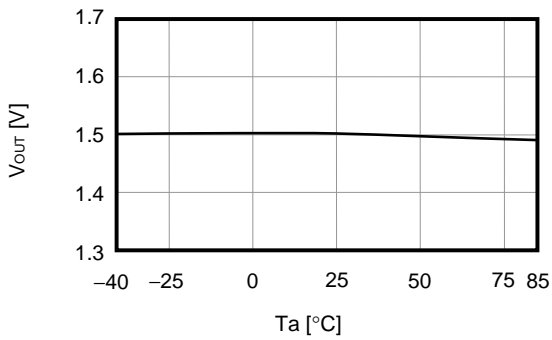

S-1701x30xx ($V_{OUT} = 3.0\text{ V}$, $I_{OUT} = 30\text{ mA}$)

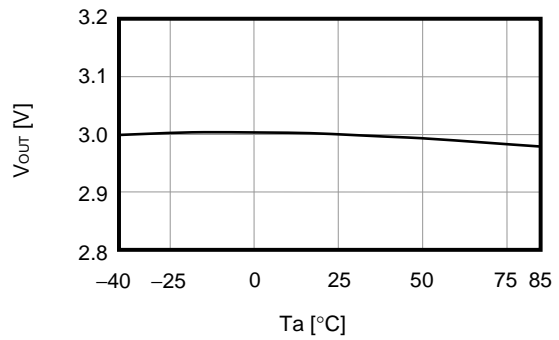

S-1701x50xx ($V_{OUT} = 5.0\text{ V}$, $I_{OUT} = 30\text{ mA}$)

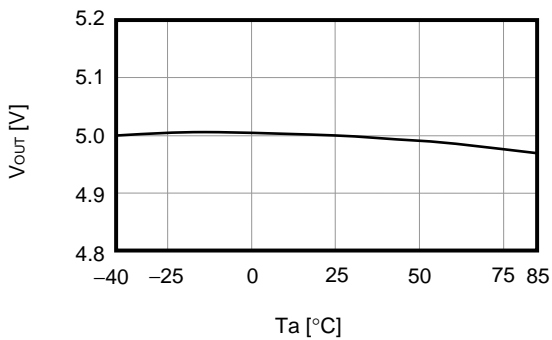

(5) Current consumption vs. Input voltage

S-1701x15xx ($V_{OUT} = 1.5\text{ V}$)

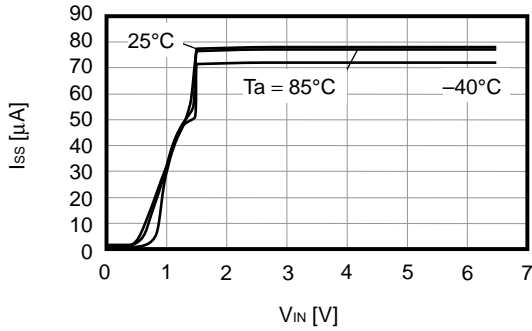

S-1701x30xx ($V_{OUT} = 3.0\text{ V}$)

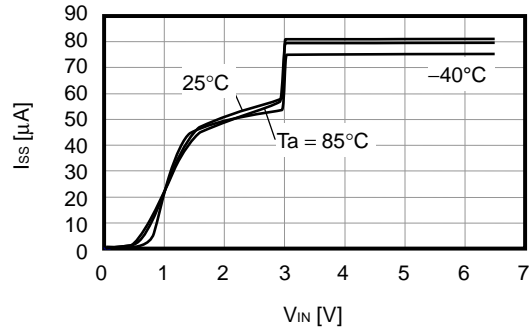

S-1701x50xx ($V_{OUT} = 5.0\text{ V}$)

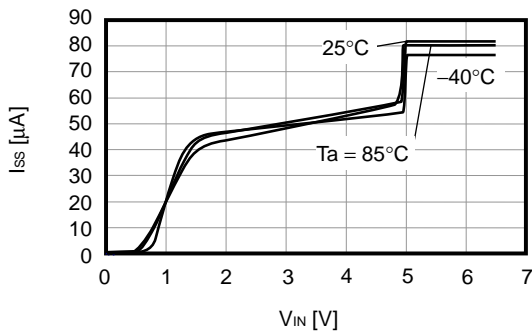

(6) Ripple rejection ratio

S-1701x15xx ($V_{OUT} = 1.5\text{ V}$, $T_a = 25^\circ\text{C}$)
 $V_{IN} = 2.5\text{ V}$, $C_L = 1.0\ \mu\text{F}$, $I_{OUT} = 30\text{ mA}$

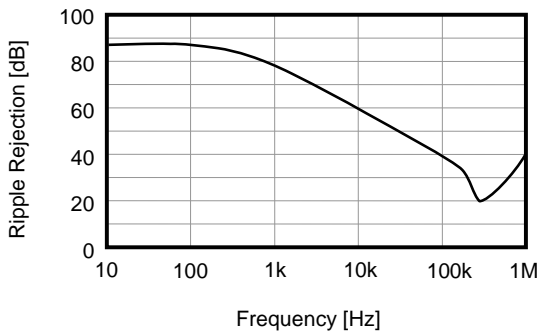

S-1701x30xx ($V_{OUT} = 3.0\text{ V}$, $T_a = 25^\circ\text{C}$)
 $V_{IN} = 4.0\text{ V}$, $C_L = 1.0\ \mu\text{F}$, $I_{OUT} = 30\text{ mA}$

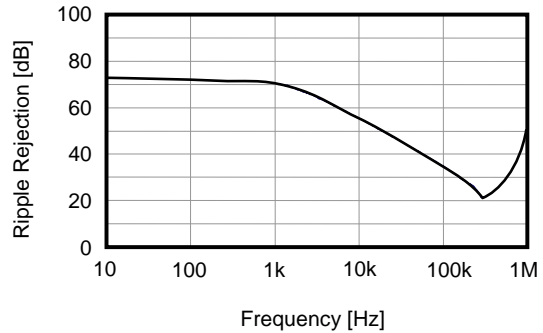

S-1701x50xx ($V_{OUT} = 5.0\text{ V}$, $T_a = 25^\circ\text{C}$)
 $V_{IN} = 6.0\text{ V}$, $C_L = 1.0\ \mu\text{F}$, $I_{OUT} = 30\text{ mA}$

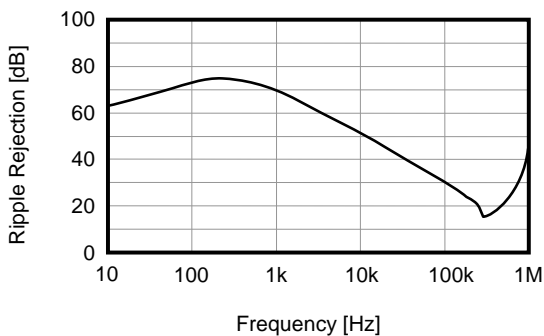

2. Detector block

(1) Detection voltage vs. Ambient temperature

S-1701xxx15 ($-V_{DET} = 1.5\text{ V}$)

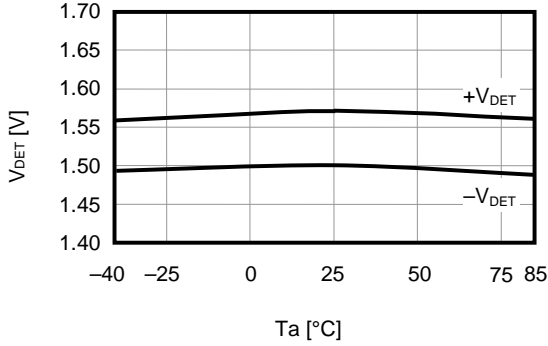

S-1701xxx55 ($-V_{DET} = 5.5\text{ V}$)

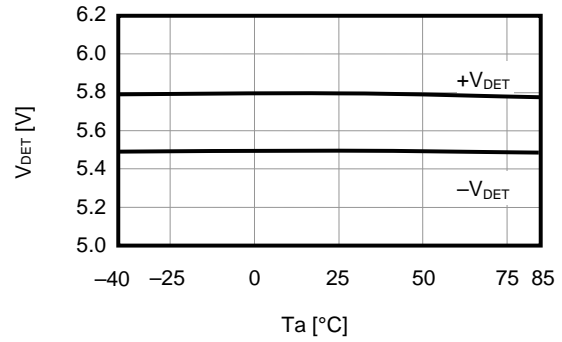

(2) Hysteresis width vs. Ambient temperature

S-1701xxx15 ($-V_{DET} = 1.5\text{ V}$)

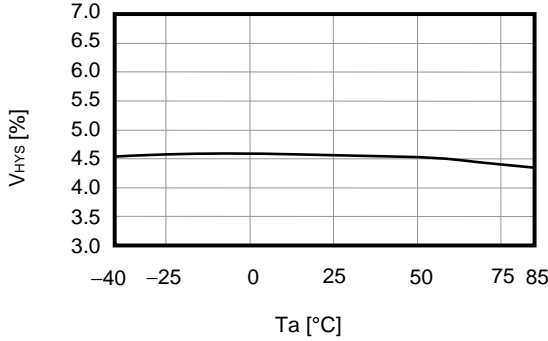

S-1701xxx55 ($-V_{DET} = 5.5\text{ V}$)

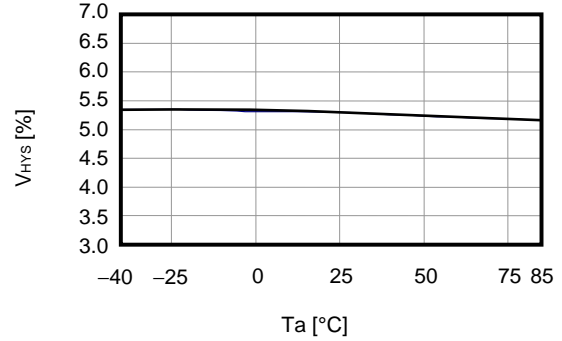

(3) Detector block current consumption vs. Input voltage

S-1701xxx15 ($-V_{DET} = 1.5\text{ V}$)

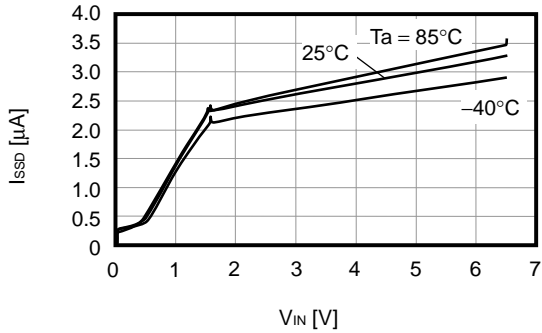

S-1701xxx55 ($-V_{DET} = 5.5\text{ V}$)

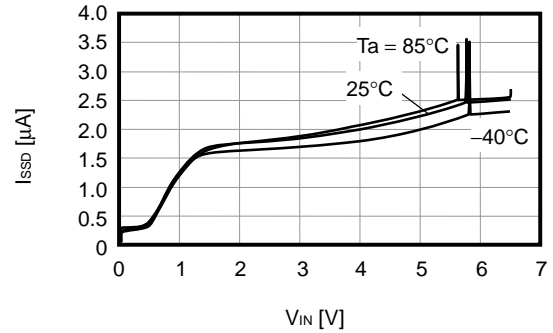

(4) Nch transistor output current vs. V_{DS} characteristics

S-1701xxx55 ($-V_{DET} = 5.5\text{ V}$, $T_a = 25^\circ\text{C}$)

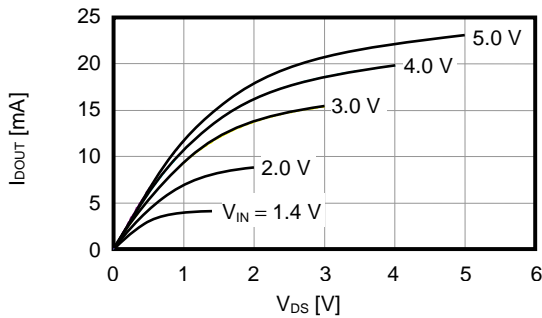

(5) Release delay time vs. Ambient temperature

S-1701xxx15 ($V_{IN} = 1.5\text{ V}$, $-V_{DET} = 1.5\text{ V}$, $t_D = 50\text{ ms}$)

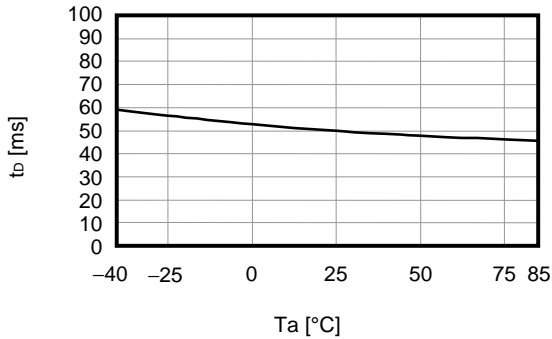

S-1701xxx55 ($V_{IN} = 5.5\text{ V}$, $-V_{DET} = 5.5\text{ V}$, $t_D = 100\text{ ms}$)

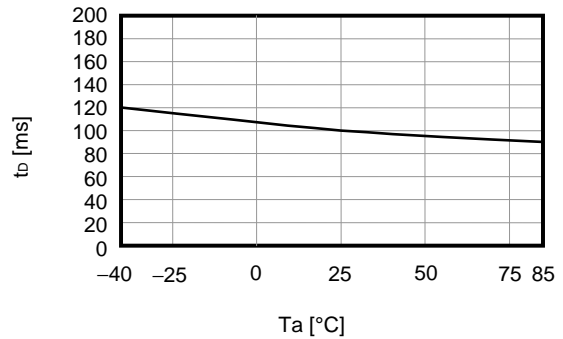

S-1701xxx45 ($V_{IN} = 4.5\text{ V}$, $-V_{DET} = 4.5\text{ V}$, $t_D = 60\text{ }\mu\text{s}$)

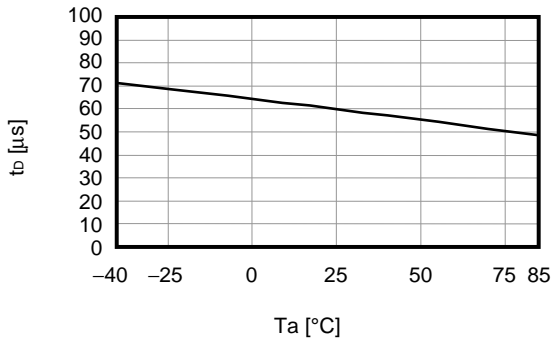

(6) Minimum operating voltage vs. Input voltage

S-1701xxx15 (5 V pull up: 100 kΩ, $-V_{DET} = 1.5\text{ V}$)

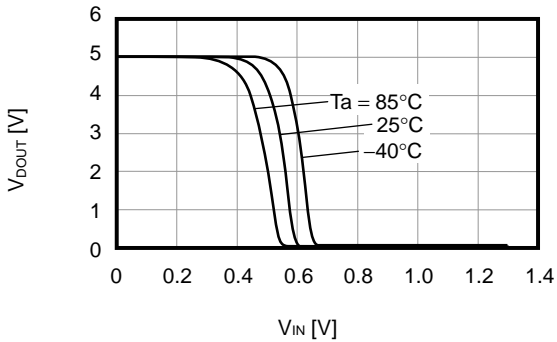

S-1701xxx15 (V_{IN} pull up: 100 kΩ, $-V_{DET} = 1.5\text{ V}$)

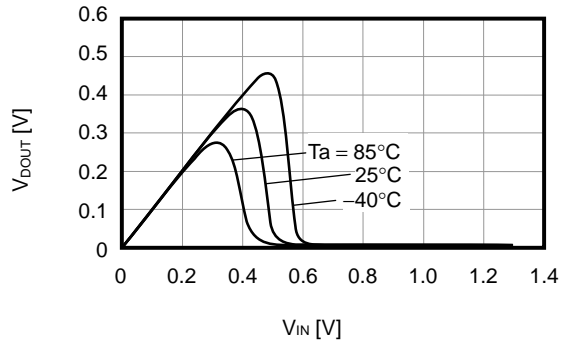

Reference Data

(1) Input transient response characteristics

S-1701x15xx ($V_{IN} = 2.5\text{ V} \leftrightarrow 3.5\text{ V}$, $V_{OUT} = 1.5\text{ V}$, $T_a = 25^\circ\text{C}$)
 $I_{OUT} = 100\text{ mA}$, $t_r = t_f = 5.0\ \mu\text{s}$, $C_L = 1.0\ \mu\text{F}$, $C_{IN} = 1.0\ \mu\text{F}$

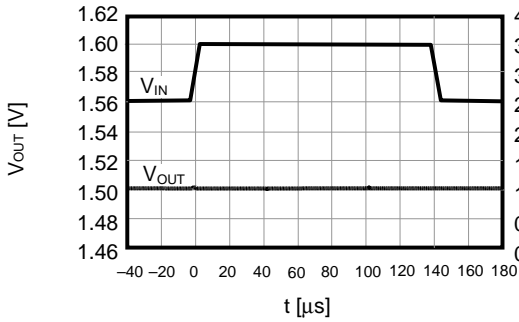

S-1701x30xx ($V_{IN} = 4.0\text{ V} \leftrightarrow 5.0\text{ V}$, $V_{OUT} = 3.0\text{ V}$, $T_a = 25^\circ\text{C}$)
 $I_{OUT} = 100\text{ mA}$, $t_r = t_f = 5.0\ \mu\text{s}$, $C_L = 1.0\ \mu\text{F}$, $C_{IN} = 1.0\ \mu\text{F}$

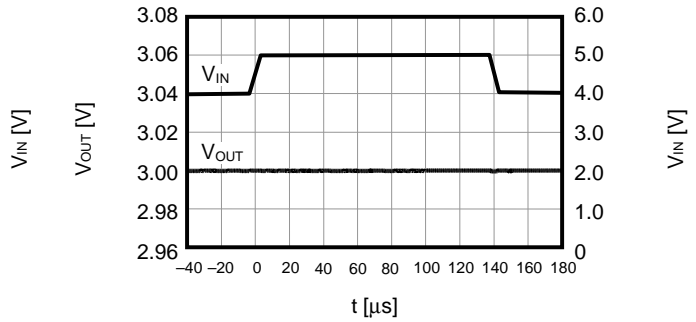

S-1701x50xx ($V_{IN} = 6.0\text{ V} \leftrightarrow 6.5\text{ V}$, $V_{OUT} = 5.0\text{ V}$, $T_a = 25^\circ\text{C}$)
 $I_{OUT} = 100\text{ mA}$, $t_r = t_f = 5.0\ \mu\text{s}$, $C_L = 1.0\ \mu\text{F}$, $C_{IN} = 1.0\ \mu\text{F}$

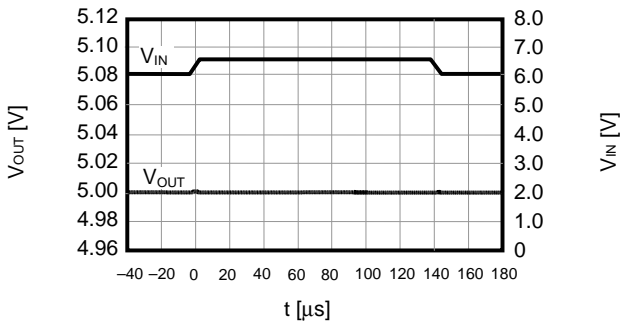

(2) Load transient response characteristics

S-1701x15xx ($V_{OUT} = 1.5\text{ V}$, $T_a = 25^\circ\text{C}$)
 $V_{IN} = 2.5\text{ V}$, $t_r = t_f = 5.0\ \mu\text{s}$, $C_L = 1.0\ \mu\text{F}$, $C_{IN} = 1.0\ \mu\text{F}$, $I_{OUT} = 50 \leftrightarrow 100\text{ mA}$

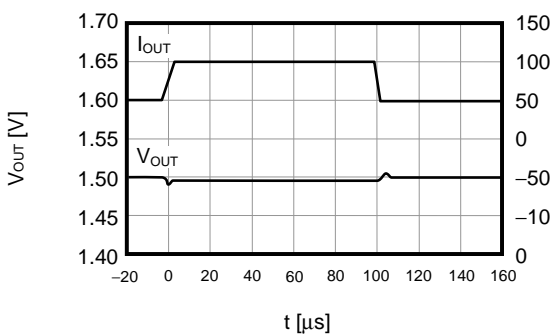

S-1701x30xx ($V_{OUT} = 3.0\text{ V}$, $T_a = 25^\circ\text{C}$)
 $V_{IN} = 4.0\text{ V}$, $t_r = t_f = 5.0\ \mu\text{s}$, $C_L = 1.0\ \mu\text{F}$, $C_{IN} = 1.0\ \mu\text{F}$, $I_{OUT} = 50 \leftrightarrow 100\text{ mA}$

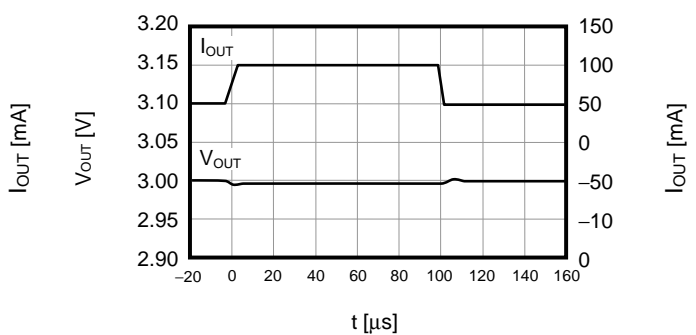

S-1701x50xx ($V_{OUT} = 5.0\text{ V}$, $T_a = 25^\circ\text{C}$)
 $V_{IN} = 6.0\text{ V}$, $t_r = t_f = 5.0\ \mu\text{s}$, $C_L = 1.0\ \mu\text{F}$, $C_{IN} = 1.0\ \mu\text{F}$, $I_{OUT} = 50 \leftrightarrow 100\text{ mA}$

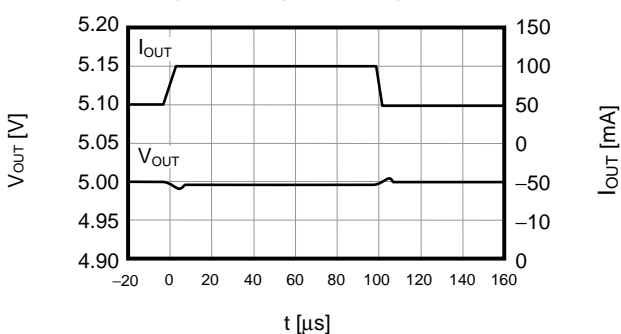

(3) ON/OFF pin transient response characteristics

S-1701x15xx ($V_{OUT} = 1.5\text{ V}$, $T_a = 25^\circ\text{C}$)

$V_{IN} = 2.5\text{ V}$, $t_r = t_f = 5.0\ \mu\text{s}$, $C_L = 1.0\ \mu\text{F}$, $C_{IN} = 1.0\ \mu\text{F}$, $I_{OUT} = 100\text{ mA}$

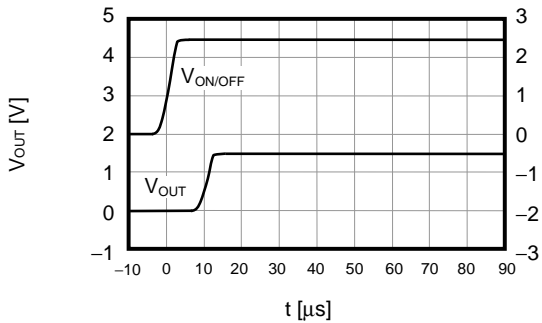

S-1701x30xx ($V_{OUT} = 3.0\text{ V}$, $T_a = 25^\circ\text{C}$)

$V_{IN} = 4.0\text{ V}$, $t_r = t_f = 5.0\ \mu\text{s}$, $C_L = 1.0\ \mu\text{F}$, $C_{IN} = 1.0\ \mu\text{F}$, $I_{OUT} = 100\text{ mA}$

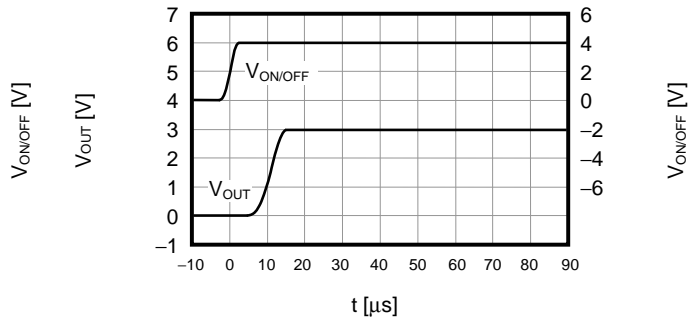

S-1701x50xx ($V_{OUT} = 5.0\text{ V}$, $T_a = 25^\circ\text{C}$)

$V_{IN} = 6.0\text{ V}$, $t_r = t_f = 5.0\ \mu\text{s}$, $C_L = 1.0\ \mu\text{F}$, $C_{IN} = 1.0\ \mu\text{F}$, $I_{OUT} = 100\text{ mA}$

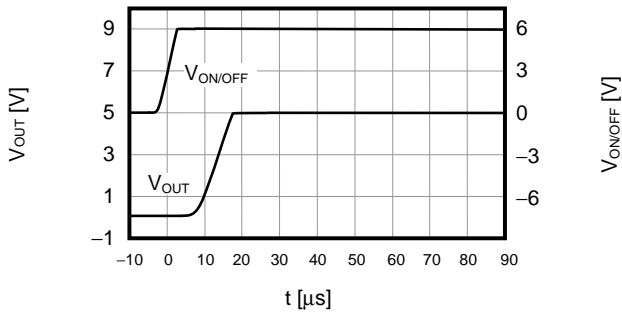

(4) Dynamic response characteristics vs. C_{DOUT}

S-1701xxx15 (V_{IN} pull up: $100\text{ k}\Omega$, $-V_{DET} = 1.5\text{ V}$, $T_a = 25^\circ\text{C}$)

S-1701xxx55 (V_{IN} pull up: $100\text{ k}\Omega$, $-V_{DET} = 5.5\text{ V}$, $T_a = 25^\circ\text{C}$)

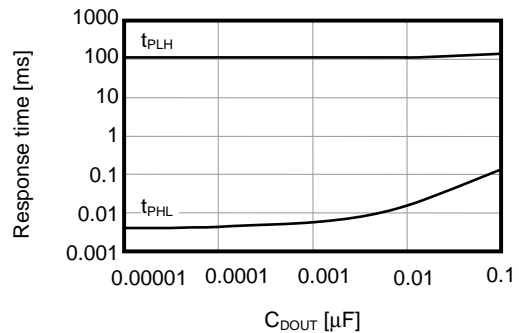
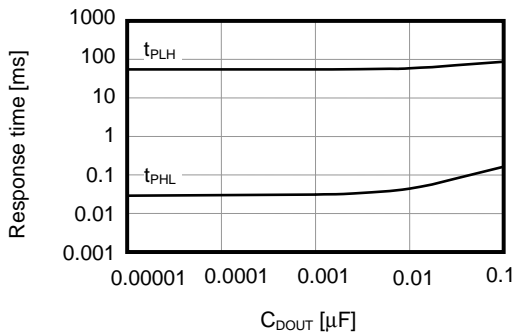

(a) Measurement conditions of dynamic response vs. C_{DOUT}

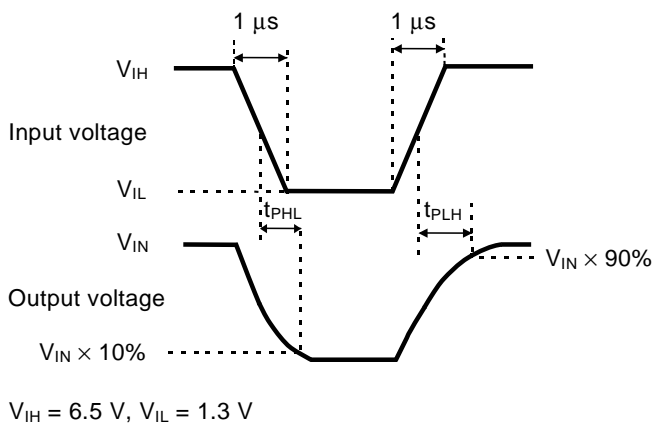

Figure 40

(b) Measurement circuit of the dynamic response for S-1701 Series A/B/C/G/H/JJ/X/Y/Z types

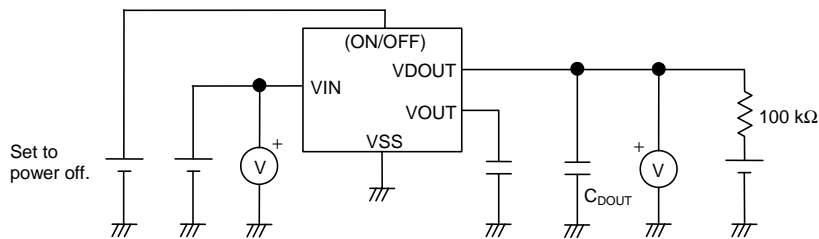

Figure 41

(c) Measurement circuit of the dynamic response for S-1701 Series D/E/F/K/L/M/U/V/W types

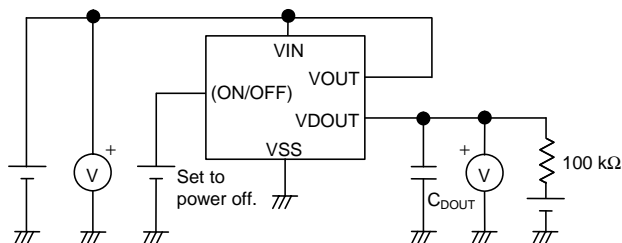

Figure 42

(d) Measurement circuit of the dynamic response for S-1701 Series N/P/Q/R/S/T types

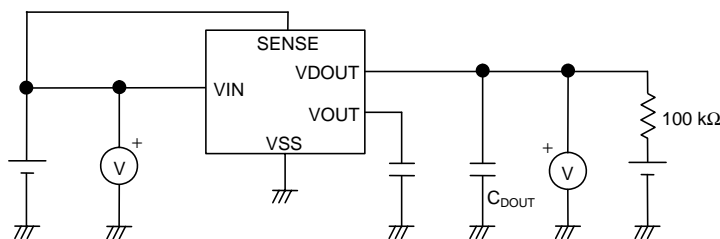
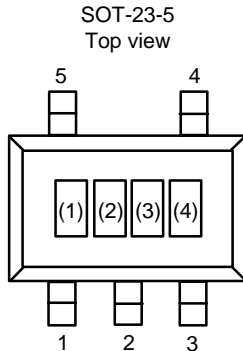

Figure 43

Caution The above connection diagrams will not guarantee successful operation. Perform thorough evaluation using the actual application to set the constants.

■ **Marking Specifications**

(1) SOT-23-5



(1) to (3):
(4):

Product code (Refer to **Product name vs. Product code**)
Lot number

Product name vs. Product code

(a) S-1701 Series A Type

Product Name	Product Code		
	(1)	(2)	(3)
S-1701A1541-M5T1x	T	B	E
S-1701A1815-M5T1x	P	6	A
S-1701A2520-M5T1x	P	6	B
S-1701A2521-M5T1x	P	6	C
S-1701A2522-M5T1x	P	6	D
S-1701A2728-M5T1x	P	6	Q
S-1701A2825-M5T1x	T	B	A
S-1701A2833-M5T1x	T	B	D
S-1701A3024-M5T1x	P	6	E
S-1701A3025-M5T1x	P	6	F
S-1701A3026-M5T1x	P	6	G
S-1701A3326-M5T1x	P	6	H
S-1701A3327-M5T1x	P	6	I
S-1701A3328-M5T1x	P	6	J
S-1701A3330-M5T1x	P	6	P
S-1701A3331-M5T1x	T	B	C
S-1701A3430-M5T1x	P	6	K
S-1701A5040-M5T1x	P	6	L
S-1701A5041-M5T1x	P	6	M
S-1701A5042-M5T1x	P	6	N
S-1701A5043-M5T1x	P	6	O

(b) S-1701 Series B Type

Product Name	Product Code		
	(1)	(2)	(3)
S-1701B1815-M5T1x	P	6	R
S-1701B1823-M5T1x	P	6	9
S-1701B1828-M5T1x	T	E	A
S-1701B2520-M5T1x	P	6	S
S-1701B2521-M5T1x	P	6	T
S-1701B2522-M5T1x	P	6	U
S-1701B3024-M5T1x	P	6	V
S-1701B3025-M5T1x	P	6	W
S-1701B3026-M5T1x	P	6	X
S-1701B3326-M5T1x	P	6	Y
S-1701B3327-M5T1x	P	6	Z
S-1701B3328-M5T1x	P	6	3
S-1701B3430-M5T1x	P	8	Y
S-1701B5040-M5T1x	P	6	4
S-1701B5041-M5T1x	P	6	5
S-1701B5042-M5T1x	P	6	6
S-1701B5043-M5T1x	P	6	7

- Remark 1.** Please contact our sales office for products with specifications other than the above.
2. x: G or U
3. Please select products of environmental code = U for Sn 100%, halogen-free products.

(c) S-1701 Series C Type

Product Name	Product Code		
	(1)	(2)	(3)
S-1701C1815-M5T1x	P	9	A
S-1701C2520-M5T1x	P	9	B
S-1701C2521-M5T1x	P	9	C
S-1701C2522-M5T1x	P	9	D
S-1701C3024-M5T1x	P	9	E
S-1701C3025-M5T1x	P	9	F
S-1701C3026-M5T1x	P	9	G
S-1701C3326-M5T1x	P	9	H
S-1701C3327-M5T1x	P	9	I
S-1701C3328-M5T1x	P	9	J
S-1701C3330-M5T1x	P	9	P
S-1701C3430-M5T1x	P	9	K
S-1701C5040-M5T1x	P	9	L
S-1701C5041-M5T1x	P	9	M
S-1701C5042-M5T1x	P	9	N
S-1701C5043-M5T1x	P	9	O

(d) S-1701 Series D Type

Product Name	Product Code		
	(1)	(2)	(3)
S-1701D1815-M5T1x	P	V	A
S-1701D1816-M5T1x	T	C	C
S-1701D1817-M5T1x	T	C	B
S-1701D2520-M5T1x	P	V	B
S-1701D2521-M5T1x	P	V	C
S-1701D2522-M5T1x	P	V	D
S-1701D2523-M5T1x	P	V	P
S-1701D2524-M5T1x	P	V	Q
S-1701D2526-M5T1x	P	V	R
S-1701D2722-M5T1x	P	V	S
S-1701D3024-M5T1x	P	V	E
S-1701D3025-M5T1x	P	V	F
S-1701D3026-M5T1x	P	V	G
S-1701D3326-M5T1x	P	V	H
S-1701D3327-M5T1x	P	V	I
S-1701D3328-M5T1x	P	V	J
S-1701D3330-M5T1x	T	C	A
S-1701D3430-M5T1x	P	V	O
S-1701D5040-M5T1x	P	V	K
S-1701D5041-M5T1x	P	V	L
S-1701D5042-M5T1x	P	V	M
S-1701D5043-M5T1x	P	V	N

(e) S-1701 Series E Type

Product Name	Product Code		
	(1)	(2)	(3)
S-1701E1815-M5T1x	P	V	T
S-1701E2520-M5T1x	P	V	U
S-1701E2521-M5T1x	P	V	V
S-1701E2522-M5T1x	P	V	W
S-1701E2722-M5T1x	P	W	C
S-1701E3024-M5T1x	P	V	X
S-1701E3025-M5T1x	P	V	Y
S-1701E3026-M5T1x	P	V	Z
S-1701E3326-M5T1x	P	V	3
S-1701E3327-M5T1x	P	V	4
S-1701E3328-M5T1x	P	V	5
S-1701E3330-M5T1x	P	W	B
S-1701E3430-M5T1x	P	W	A
S-1701E5040-M5T1x	P	V	6
S-1701E5041-M5T1x	P	V	7
S-1701E5042-M5T1x	P	V	8
S-1701E5043-M5T1x	P	V	9

(f) S-1701 Series F Type

Product Name	Product Code		
	(1)	(2)	(3)
S-1701F1815-M5T1x	P	W	F
S-1701F2520-M5T1x	P	W	G
S-1701F2521-M5T1x	P	W	H
S-1701F2522-M5T1x	P	W	I
S-1701F2722-M5T1x	P	W	U
S-1701F3024-M5T1x	P	W	J
S-1701F3025-M5T1x	P	W	K
S-1701F3026-M5T1x	P	W	L
S-1701F3326-M5T1x	P	W	M
S-1701F3327-M5T1x	P	W	N
S-1701F3328-M5T1x	P	W	O
S-1701F3430-M5T1x	P	W	T
S-1701F5040-M5T1x	P	W	P
S-1701F5041-M5T1x	P	W	Q
S-1701F5042-M5T1x	P	W	R
S-1701F5043-M5T1x	P	W	S

- Remark 1.** Please contact our sales office for products with specifications other than the above.
2. x: G or U
3. Please select products of environmental code = U for Sn 100%, halogen-free products.

(g) S-1701 Series G Type

Product Name	Product Code		
	(1)	(2)	(3)
S-1701G2524-M5T1x	T	A	N
S-1701G3331-M5T1x	T	A	O

(h) S-1701 Series M Type

Product Name	Product Code		
	(1)	(2)	(3)
S-1701M1815-M5T1x	T	D	A

(i) S-1701 Series N Type

Product Name	Product Code		
	(1)	(2)	(3)
S-1701N1515-M5T1x	P	W	Y
S-1701N1815-M5T1x	P	W	Z
S-1701N1827-M5T1x	P	W	9
S-1701N2515-M5T1x	P	W	3
S-1701N2715-M5T1x	P	W	4
S-1701N2724-M5T1x	P	X	D
S-1701N3015-M5T1x	P	W	5
S-1701N3315-M5T1x	P	W	6
S-1701N3330-M5T1x	P	X	F
S-1701N5015-M5T1x	P	W	7

(j) S-1701 Series P Type

Product Name	Product Code		
	(1)	(2)	(3)
S-1701P1515-M5T1x	P	X	I
S-1701P1527-M5T1x	P	X	P
S-1701P1815-M5T1x	P	X	J
S-1701P2515-M5T1x	P	X	K
S-1701P2715-M5T1x	P	X	L
S-1701P3015-M5T1x	P	X	M
S-1701P3315-M5T1x	P	X	N
S-1701P5015-M5T1x	P	X	O

(k) S-1701 Series Q Type

Product Name	Product Code		
	(1)	(2)	(3)
S-1701Q1515-M5T1x	P	X	Z
S-1701Q1815-M5T1x	P	X	3
S-1701Q2515-M5T1x	P	X	4
S-1701Q2715-M5T1x	P	X	5
S-1701Q3015-M5T1x	P	X	6
S-1701Q3315-M5T1x	P	X	7
S-1701Q5015-M5T1x	P	X	8

(l) S-1701 Series R Type

Product Name	Product Code		
	(1)	(2)	(3)
S-1701R1515-M5T1x	P	Y	E
S-1701R1815-M5T1x	P	Y	F
S-1701R2515-M5T1x	P	Y	G
S-1701R2715-M5T1x	P	Y	H
S-1701R3015-M5T1x	P	Y	I
S-1701R3315-M5T1x	P	Y	J
S-1701R5015-M5T1x	P	Y	K

(m) S-1701 Series S Type

Product Name	Product Code		
	(1)	(2)	(3)
S-1701S1515-M5T1x	P	Y	Q
S-1701S1815-M5T1x	P	Y	R
S-1701S2515-M5T1x	P	Y	S
S-1701S2715-M5T1x	P	Y	T
S-1701S3015-M5T1x	P	Y	U
S-1701S3315-M5T1x	P	Y	V
S-1701S5015-M5T1x	P	Y	W

(n) S-1701 Series T Type

Product Name	Product Code		
	(1)	(2)	(3)
S-1701T1515-M5T1x	P	Z	A
S-1701T1815-M5T1x	P	Z	B
S-1701T2515-M5T1x	P	Z	C
S-1701T2715-M5T1x	P	Z	D
S-1701T3015-M5T1x	P	Z	E
S-1701T3315-M5T1x	P	Z	F
S-1701T3325-M5T1x	P	Z	H
S-1701T5015-M5T1x	P	Z	G

- Remark 1.** Please contact our sales office for products with specifications other than the above.
2. x: G or U
 3. Please select products of environmental code = U for Sn 100%, halogen-free products.

(o) S-1701 Series U Type

Product Name	Product Code		
	(1)	(2)	(3)
S-1701U1815-M5T1x	P	Z	R
S-1701U2520-M5T1x	P	Z	S
S-1701U2521-M5T1x	P	Z	T
S-1701U2522-M5T1x	P	Z	U
S-1701U3024-M5T1x	P	Z	V
S-1701U3025-M5T1x	P	Z	W
S-1701U3026-M5T1x	P	Z	X
S-1701U3326-M5T1x	P	Z	Y
S-1701U3327-M5T1x	P	Z	Z
S-1701U3328-M5T1x	P	Z	3
S-1701U3430-M5T1x	P	Z	8
S-1701U5040-M5T1x	P	Z	4
S-1701U5041-M5T1x	P	Z	5
S-1701U5042-M5T1x	P	Z	6
S-1701U5043-M5T1x	P	Z	7

(p) S-1701 Series V Type

Product Name	Product Code		
	(1)	(2)	(3)
S-1701V1815-M5T1x	P	7	E
S-1701V2520-M5T1x	P	7	F
S-1701V2521-M5T1x	P	7	G
S-1701V2522-M5T1x	P	7	H
S-1701V3024-M5T1x	P	7	I
S-1701V3025-M5T1x	P	7	J
S-1701V3026-M5T1x	P	7	K
S-1701V3227-M5T1x	P	7	U
S-1701V3325-M5T1x	P	7	T
S-1701V3326-M5T1x	P	7	L
S-1701V3327-M5T1x	P	7	M
S-1701V3328-M5T1x	P	7	N
S-1701V3430-M5T1x	P	7	S
S-1701V5040-M5T1x	P	7	O
S-1701V5041-M5T1x	P	7	P
S-1701V5042-M5T1x	P	7	Q
S-1701V5043-M5T1x	P	7	R

(q) S-1701 Series W Type

Product Name	Product Code		
	(1)	(2)	(3)
S-1701W1626-M5T1x	P	8	H
S-1701W1815-M5T1x	P	7	X
S-1701W2520-M5T1x	P	7	Y
S-1701W2521-M5T1x	P	7	Z
S-1701W2522-M5T1x	P	7	3
S-1701W3024-M5T1x	P	7	4
S-1701W3025-M5T1x	P	7	5
S-1701W3026-M5T1x	P	7	6
S-1701W3227-M5T1x	P	8	G
S-1701W3326-M5T1x	P	7	7
S-1701W3327-M5T1x	P	7	8
S-1701W3328-M5T1x	P	7	9
S-1701W3430-M5T1x	P	8	E
S-1701W5040-M5T1x	P	8	A
S-1701W5041-M5T1x	P	8	B
S-1701W5042-M5T1x	P	8	C
S-1701W5043-M5T1x	P	8	D

(r) S-1701 Series X Type

Product Name	Product Code		
	(1)	(2)	(3)
S-1701X1525-M5T1x	P	8	M
S-1701X1825-M5T1x	P	8	3
S-1701X2219-M5T1x	P	8	K
S-1701X3025-M5T1x	P	8	4
S-1701X3228-M5T1x	P	8	J
S-1701X3315-M5T1x	P	8	N

(s) S-1701 Series Y Type

Product Name	Product Code		
	(1)	(2)	(3)
S-1701Y3228-M5T1x	P	8	O
S-1701Y3342-M5T1x	P	8	Q

(t) S-1701 Series Z Type

Product Name	Product Code		
	(1)	(2)	(3)
S-1701Z1626-M5T1x	P	8	U
S-1701Z1826-M5T1x	P	8	V
S-1701Z3228-M5T1x	P	8	T
S-1701Z3330-M5T1x	P	8	W

- Remark 1.** Please contact our sales office for products with specifications other than the above.
2. x: G or U
3. Please select products of environmental code = U for Sn 100%, halogen-free products.

HIGH RIPPLE-REJECTION LOW DROPOUT CMOS VOLTAGE REGULATOR WITH RESET FUNCTION

Rev.3.0_00

S-1701 Series

(2) SOT-89-5

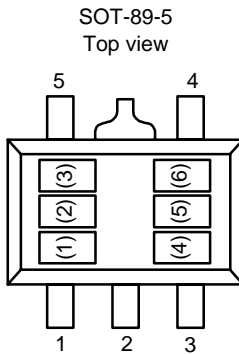

(1) to (3):
(4) to (6):

Product code (Refer to **Product name vs. Product code**)
Lot number

Product name vs. Product code

(a) S-1701 Series A Type

Product Name	Product Code		
	(1)	(2)	(3)
S-1701A1815-U5T1x	P	6	A
S-1701A2520-U5T1x	P	6	B
S-1701A2521-U5T1x	P	6	C
S-1701A2522-U5T1x	P	6	D
S-1701A3024-U5T1x	P	6	E
S-1701A3025-U5T1x	P	6	F
S-1701A3026-U5T1x	P	6	G
S-1701A3326-U5T1x	P	6	H
S-1701A3327-U5T1x	P	6	I
S-1701A3328-U5T1x	P	6	J
S-1701A3430-U5T1x	P	6	K
S-1701A5040-U5T1x	P	6	L
S-1701A5041-U5T1x	P	6	M
S-1701A5042-U5T1x	P	6	N
S-1701A5043-U5T1x	P	6	O

(b) S-1701 Series B Type

Product Name	Product Code		
	(1)	(2)	(3)
S-1701B1815-U5T1x	P	6	R
S-1701B2520-U5T1x	P	6	S
S-1701B2521-U5T1x	P	6	T
S-1701B2522-U5T1x	P	6	U
S-1701B3024-U5T1x	P	6	V
S-1701B3025-U5T1x	P	6	W
S-1701B3026-U5T1x	P	6	X
S-1701B3326-U5T1x	P	6	Y
S-1701B3327-U5T1x	P	6	Z
S-1701B3328-U5T1x	P	6	3
S-1701B3342-U5T1x	P	6	8
S-1701B3430-U5T1x	P	8	Y
S-1701B5040-U5T1x	P	6	4
S-1701B5041-U5T1x	P	6	5
S-1701B5042-U5T1x	P	6	6
S-1701B5043-U5T1x	P	6	7

(c) S-1701 Series C Type

Product Name	Product Code		
	(1)	(2)	(3)
S-1701C1815-U5T1x	P	9	A
S-1701C1830-U5T1x	P	9	Q
S-1701C2520-U5T1x	P	9	B
S-1701C2521-U5T1x	P	9	C
S-1701C2522-U5T1x	P	9	D
S-1701C3024-U5T1x	P	9	E
S-1701C3025-U5T1x	P	9	F
S-1701C3026-U5T1x	P	9	G
S-1701C3326-U5T1x	P	9	H
S-1701C3327-U5T1x	P	9	I
S-1701C3328-U5T1x	P	9	J
S-1701C3430-U5T1x	P	9	K
S-1701C5040-U5T1x	P	9	L
S-1701C5041-U5T1x	P	9	M
S-1701C5042-U5T1x	P	9	N
S-1701C5043-U5T1x	P	9	O

(d) S-1701 Series D Type

Product Name	Product Code		
	(1)	(2)	(3)
S-1701D1815-U5T1x	P	V	A
S-1701D2520-U5T1x	P	V	B
S-1701D2521-U5T1x	P	V	C
S-1701D2522-U5T1x	P	V	D
S-1701D3024-U5T1x	P	V	E
S-1701D3025-U5T1x	P	V	F
S-1701D3026-U5T1x	P	V	G
S-1701D3326-U5T1x	P	V	H
S-1701D3327-U5T1x	P	V	I
S-1701D3328-U5T1x	P	V	J
S-1701D3430-U5T1x	P	V	O
S-1701D5040-U5T1x	P	V	K
S-1701D5041-U5T1x	P	V	L
S-1701D5042-U5T1x	P	V	M
S-1701D5043-U5T1x	P	V	N

Remark 1. Please contact our sales office for products with specifications other than the above.

2. x: G or U

3. Please select products of environmental code = U for Sn 100%, halogen-free products.

(e) S-1701 Series E Type

Product Name	Product Code		
	(1)	(2)	(3)
S-1701E1815-U5T1x	P	V	T
S-1701E2520-U5T1x	P	V	U
S-1701E2521-U5T1x	P	V	V
S-1701E2522-U5T1x	P	V	W
S-1701E3024-U5T1x	P	V	X
S-1701E3025-U5T1x	P	V	Y
S-1701E3026-U5T1x	P	V	Z
S-1701E3326-U5T1x	P	V	3
S-1701E3327-U5T1x	P	V	4
S-1701E3328-U5T1x	P	V	5
S-1701E3430-U5T1x	P	W	A
S-1701E5040-U5T1x	P	V	6
S-1701E5041-U5T1x	P	V	7
S-1701E5042-U5T1x	P	V	8
S-1701E5043-U5T1x	P	V	9

(f) S-1701 Series F Type

Product Name	Product Code		
	(1)	(2)	(3)
S-1701F1815-U5T1x	P	W	F
S-1701F2520-U5T1x	P	W	G
S-1701F2521-U5T1x	P	W	H
S-1701F2522-U5T1x	P	W	I
S-1701F3024-U5T1x	P	W	J
S-1701F3025-U5T1x	P	W	K
S-1701F3026-U5T1x	P	W	L
S-1701F3326-U5T1x	P	W	M
S-1701F3327-U5T1x	P	W	N
S-1701F3328-U5T1x	P	W	O
S-1701F3430-U5T1x	P	W	T
S-1701F5040-U5T1x	P	W	P
S-1701F5041-U5T1x	P	W	Q
S-1701F5042-U5T1x	P	W	R
S-1701F5043-U5T1x	P	W	S

(g) S-1701 Series H Type

Product Name	Product Code		
	(1)	(2)	(3)
S-1701H5045-U5T1x	T	A	A

(h) S-1701 Series N Type

Product Name	Product Code		
	(1)	(2)	(3)
S-1701N1515-U5T1x	P	W	Y
S-1701N1815-U5T1x	P	W	Z
S-1701N1824-U5T1x	P	X	C
S-1701N2515-U5T1x	P	W	3
S-1701N2715-U5T1x	P	W	4
S-1701N2724-U5T1x	P	X	D
S-1701N3015-U5T1x	P	W	5
S-1701N3315-U5T1x	P	W	6
S-1701N3330-U5T1x	P	X	F
S-1701N5015-U5T1x	P	W	7

(i) S-1701 Series P Type

Product Name	Product Code		
	(1)	(2)	(3)
S-1701P1515-U5T1x	P	X	I
S-1701P1815-U5T1x	P	X	J
S-1701P2515-U5T1x	P	X	K
S-1701P2715-U5T1x	P	X	L
S-1701P2843-U5T1x	P	X	Q
S-1701P2844-U5T1x	P	X	R
S-1701P3015-U5T1x	P	X	M
S-1701P3315-U5T1x	P	X	N
S-1701P5015-U5T1x	P	X	O

(j) S-1701 Series Q Type

Product Name	Product Code		
	(1)	(2)	(3)
S-1701Q1515-U5T1x	P	X	Z
S-1701Q1815-U5T1x	P	X	3
S-1701Q2515-U5T1x	P	X	4
S-1701Q2715-U5T1x	P	X	5
S-1701Q3015-U5T1x	P	X	6
S-1701Q3227-U5T1x	P	X	9
S-1701Q3242-U5T1x	P	Y	A
S-1701Q3315-U5T1x	P	X	7
S-1701Q5015-U5T1x	P	X	8

- Remark 1.** Please contact our sales office for products with specifications other than the above.
2. x: G or U
3. Please select products of environmental code = U for Sn 100%, halogen-free products.

HIGH RIPPLE-REJECTION LOW DROPOUT CMOS VOLTAGE REGULATOR WITH RESET FUNCTION

Rev.3.0_00

S-1701 Series

(k) S-1701 Series R Type

Product Name	Product Code		
	(1)	(2)	(3)
S-1701R1515-U5T1x	P	Y	E
S-1701R1815-U5T1x	P	Y	F
S-1701R2515-U5T1x	P	Y	G
S-1701R2715-U5T1x	P	Y	H
S-1701R3015-U5T1x	P	Y	I
S-1701R3315-U5T1x	P	Y	J
S-1701R5015-U5T1x	P	Y	K

(l) S-1701 Series S Type

Product Name	Product Code		
	(1)	(2)	(3)
S-1701S1515-U5T1x	P	Y	Q
S-1701S1815-U5T1x	P	Y	R
S-1701S2515-U5T1x	P	Y	S
S-1701S2715-U5T1x	P	Y	T
S-1701S3015-U5T1x	P	Y	U
S-1701S3315-U5T1x	P	Y	V
S-1701S5015-U5T1x	P	Y	W

(m) S-1701 Series T Type

Product Name	Product Code		
	(1)	(2)	(3)
S-1701T1515-U5T1x	P	Z	A
S-1701T1815-U5T1x	P	Z	B
S-1701T2515-U5T1x	P	Z	C
S-1701T2715-U5T1x	P	Z	D
S-1701T3015-U5T1x	P	Z	E
S-1701T3315-U5T1x	P	Z	F
S-1701T5015-U5T1x	P	Z	G

(n) S-1701 Series U Type

Product Name	Product Code		
	(1)	(2)	(3)
S-1701U1815-U5T1x	P	Z	R
S-1701U2520-U5T1x	P	Z	S
S-1701U2521-U5T1x	P	Z	T
S-1701U2522-U5T1x	P	Z	U
S-1701U3024-U5T1x	P	Z	V
S-1701U3025-U5T1x	P	Z	W
S-1701U3026-U5T1x	P	Z	X
S-1701U3326-U5T1x	P	Z	Y
S-1701U3327-U5T1x	P	Z	Z
S-1701U3328-U5T1x	P	Z	3
S-1701U3430-U5T1x	P	Z	8
S-1701U5040-U5T1x	P	Z	4
S-1701U5041-U5T1x	P	Z	5
S-1701U5042-U5T1x	P	Z	6
S-1701U5043-U5T1x	P	Z	7

(o) S-1701 Series V Type

Product Name	Product Code		
	(1)	(2)	(3)
S-1701V1815-U5T1x	P	7	E
S-1701V2520-U5T1x	P	7	F
S-1701V2521-U5T1x	P	7	G
S-1701V2522-U5T1x	P	7	H
S-1701V3024-U5T1x	P	7	I
S-1701V3025-U5T1x	P	7	J
S-1701V3026-U5T1x	P	7	K
S-1701V3326-U5T1x	P	7	L
S-1701V3327-U5T1x	P	7	M
S-1701V3328-U5T1x	P	7	N
S-1701V3430-U5T1x	P	7	S
S-1701V5040-U5T1x	P	7	O
S-1701V5041-U5T1x	P	7	P
S-1701V5042-U5T1x	P	7	Q
S-1701V5043-U5T1x	P	7	R

(p) S-1701 Series W Type

Product Name	Product Code		
	(1)	(2)	(3)
S-1701W1815-U5T1x	P	7	X
S-1701W2520-U5T1x	P	7	Y
S-1701W2521-U5T1x	P	7	Z
S-1701W2522-U5T1x	P	7	3
S-1701W3024-U5T1x	P	7	4
S-1701W3025-U5T1x	P	7	5
S-1701W3026-U5T1x	P	7	6
S-1701W3324-U5T1x	P	8	F
S-1701W3326-U5T1x	P	7	7
S-1701W3327-U5T1x	P	7	8
S-1701W3328-U5T1x	P	7	9
S-1701W3430-U5T1x	P	8	E
S-1701W5040-U5T1x	P	8	A
S-1701W5041-U5T1x	P	8	B
S-1701W5042-U5T1x	P	8	C
S-1701W5043-U5T1x	P	8	D

- Remark 1.** Please contact our sales office for products with specifications other than the above.
2. x: G or U
 3. Please select products of environmental code = U for Sn 100%, halogen-free products.

(g) S-1701 Series X Type

Product Name	Product Code		
	(1)	(2)	(3)
S-1701X3228-U5T1x	P	8	J
S-1701X3330-U5T1x	P	8	L
S-1701X3342-U5T1x	P	8	5

(r) S-1701 Series Y Type

Product Name	Product Code		
	(1)	(2)	(3)
S-1701Y3228-U5T1x	P	8	O
S-1701Y3330-U5T1x	P	8	S
S-1701Y3340-U5T1x	P	8	P
S-1701Y3342-U5T1x	P	8	Q

(s) S-1701 Series Z Type

Product Name	Product Code		
	(1)	(2)	(3)
S-1701Z3228-U5T1x	P	8	T

- Remark 1.** Please contact our sales office for products with specifications other than the above.
2. x: G or U
 3. Please select products of environmental code = U for Sn 100%, halogen-free products.



No. MP005-A-P-SD-1.2

TITLE	SOT235-A-PKG Dimensions
No.	MP005-A-P-SD-1.2
SCALE	
UNIT	mm
Seiko Instruments Inc.	



No. MP005-A-C-SD-2.1

TITLE	SOT235-A-Carrier Tape
No.	MP005-A-C-SD-2.1
SCALE	
UNIT	mm
Seiko Instruments Inc.	



Enlarged drawing in the central part



No. MP005-A-R-SD-1.1

TITLE	SOT235-A-Reel		
No.	MP005-A-R-SD-1.1		
SCALE		QTY.	3,000
UNIT	mm		
Seiko Instruments Inc.			

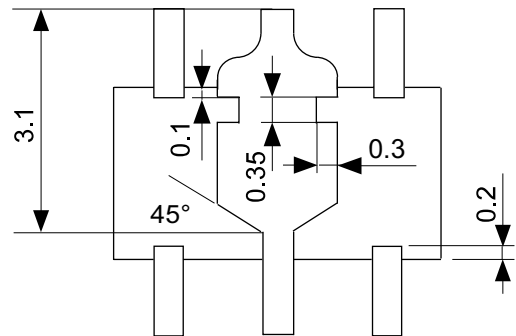
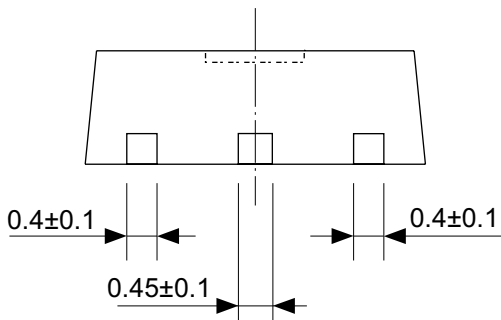
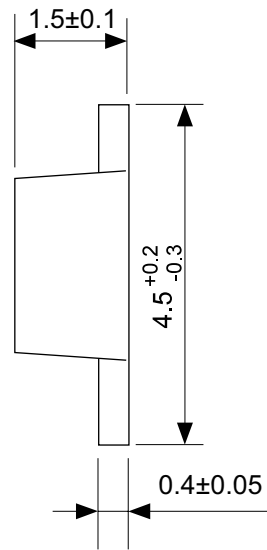
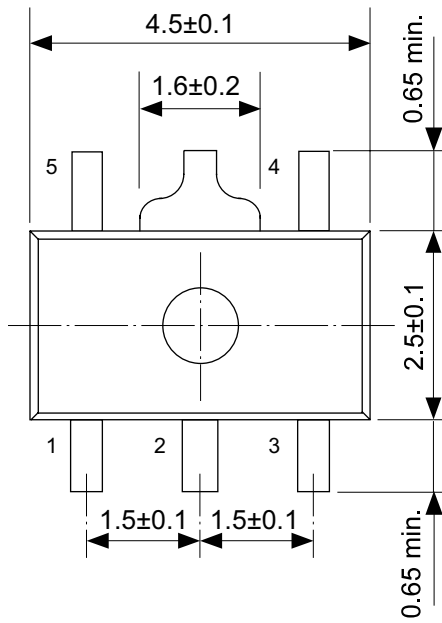

No. UP005-A-P-SD-1.1

TITLE	SOT895-A-PKG Dimensions
No.	UP005-A-P-SD-1.1
SCALE	
UNIT	mm
Seiko Instruments Inc.	

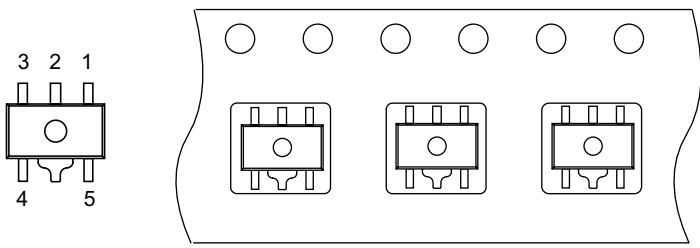
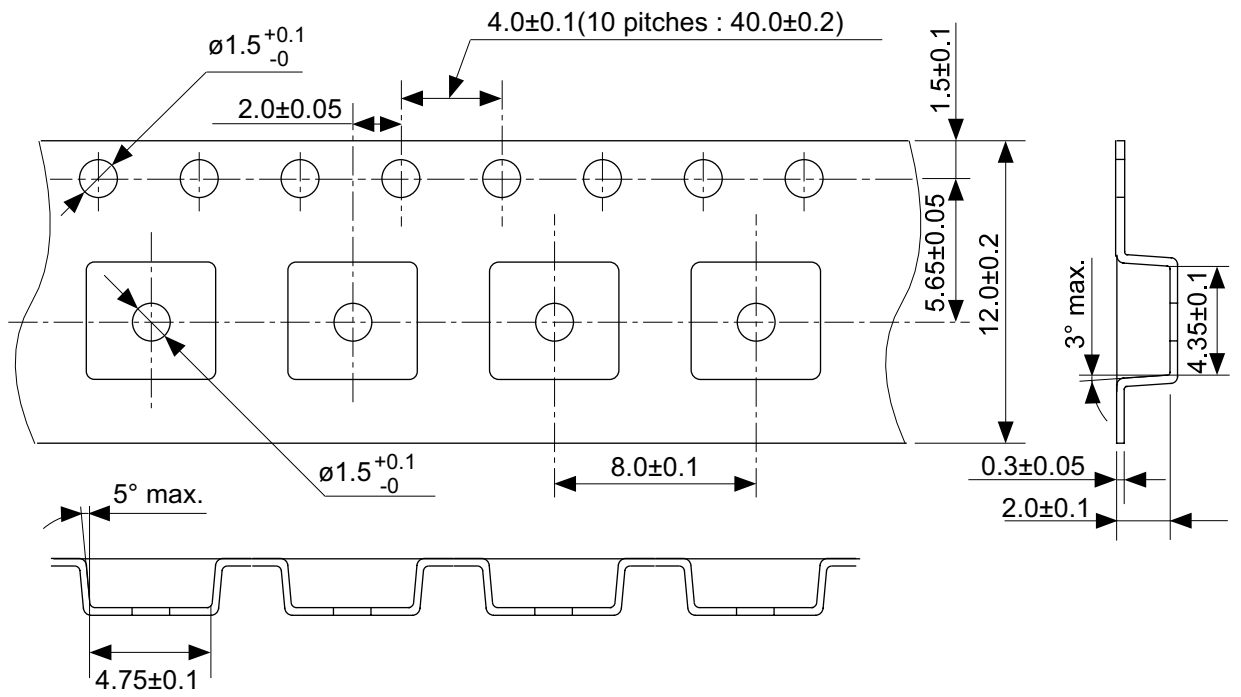

No. UP005-A-C-SD-1.1

TITLE	SOT895-A-Carrier Tape
No.	UP005-A-C-SD-1.1
SCALE	
UNIT	mm

Seiko Instruments Inc.

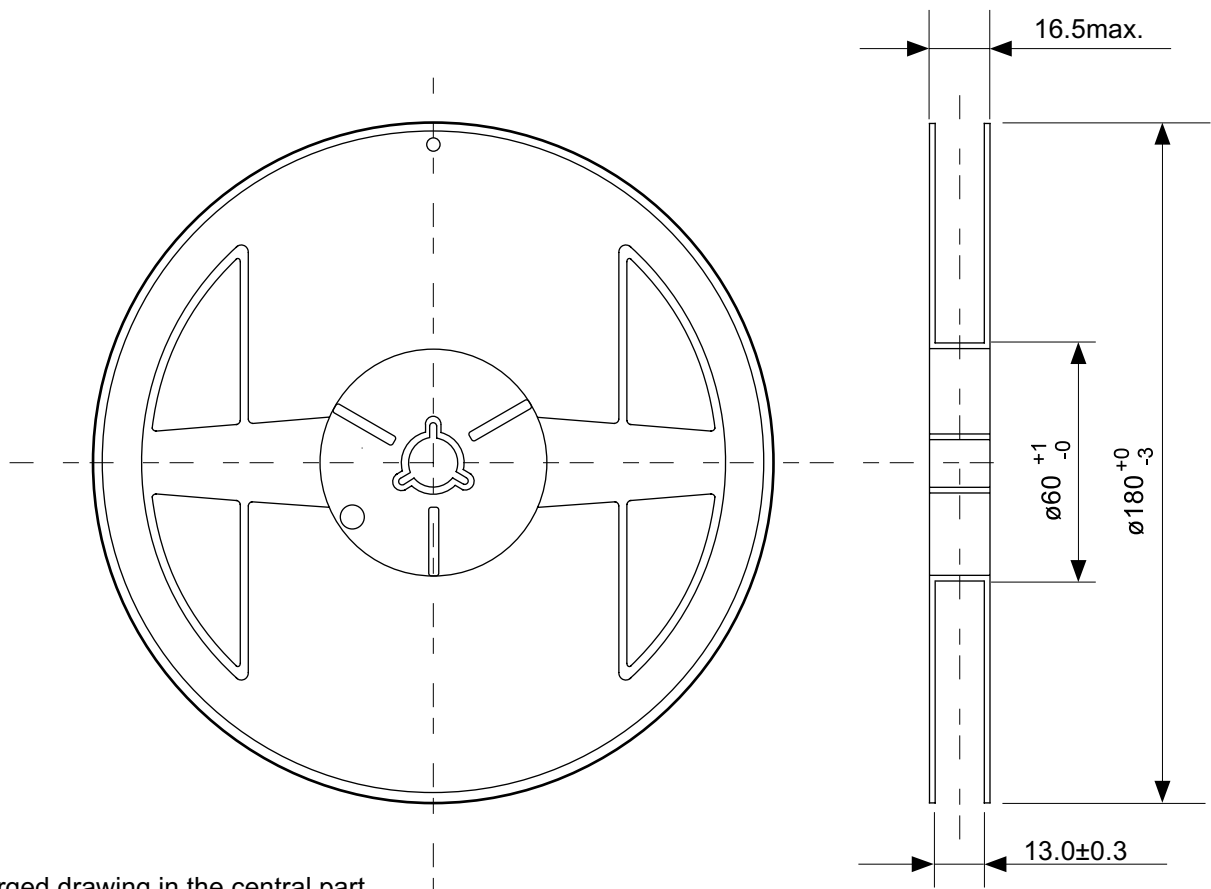

Enlarged drawing in the central part

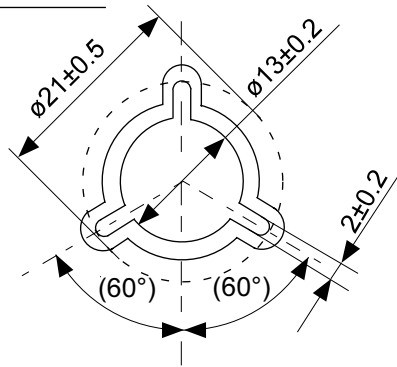

No. UP005-A-R-SD-1.1

TITLE	SOT895-A-Reel		
No.	UP005-A-R-SD-1.1		
SCALE		QTY.	1,000
UNIT	mm		
Seiko Instruments Inc.			



Seiko Instruments Inc.
www.sii-ic.com

- The information described herein is subject to change without notice.
- Seiko Instruments Inc. is not responsible for any problems caused by circuits or diagrams described herein whose related industrial properties, patents, or other rights belong to third parties. The application circuit examples explain typical applications of the products, and do not guarantee the success of any specific mass-production design.
- When the products described herein are regulated products subject to the Wassenaar Arrangement or other agreements, they may not be exported without authorization from the appropriate governmental authority.
- Use of the information described herein for other purposes and/or reproduction or copying without the express permission of Seiko Instruments Inc. is strictly prohibited.
- The products described herein cannot be used as part of any device or equipment affecting the human body, such as exercise equipment, medical equipment, security systems, gas equipment, or any apparatus installed in airplanes and other vehicles, without prior written permission of Seiko Instruments Inc.
- Although Seiko Instruments Inc. exerts the greatest possible effort to ensure high quality and reliability, the failure or malfunction of semiconductor products may occur. The user of these products should therefore give thorough consideration to safety design, including redundancy, fire-prevention measures, and malfunction prevention, to prevent any accidents, fires, or community damage that may ensue.