



MICROMINIATURE – COTS MICRO-D CONNECTORS

HDM10 THRU 15 – RIGHT ANGLE PC BOARD TERMINATION

HIRELCO PART NUMBER CODE

HDM 1* - * * * * *

HIRELCO CONNECTOR SERIES

HDM - MICRO D-SUBMINIATURE
(DESIGNS BASED ON M83513)

CONNECTOR TYPE, GENDER, & TERMINATION

- 10 - METAL SHELL PLUG, NARROW PROFILE, R/A PCB MOUNT (SIZES 9-37)
- 11 - METAL SHELL PLUG, NARROW PROFILE, R/A PCB MOUNT (SIZE 51)
- 12 - METAL SHELL PLUG, NARROW PROFILE, R/A PCB MOUNT (SIZE 100)
- 13 - METAL SHELL RECEPTACLE, NARROW PROFILE, R/A PCB MOUNT (SIZES 9-37)
- 14 - METAL SHELL RECEPTACLE, NARROW PROFILE, R/A PCB MOUNT (SIZE 51)
- 15 - METAL SHELL RECEPTACLE, NARROW PROFILE, R/A PCB MOUNT (SIZE 100)

CONNECTOR SIZE

(NUMBER OF CONTACTS) <4>

A=9, B=15, C=21, D=25, E=31, F=37, G=51, & H=100

LEAD LENGTH

(24 AWG HOT SOLDER DIPPED)

- 1 - .109 ±.015
- 2 - .140 ±.015
- 3 - .172 ±.015
- 4 - .190 ±.015
- 5 - .250 ±.015

FLANGE HARDWARE

SIZES 9-51 USES #2-56, 100 USES #4-40

- N - NO FLANGE HARDWARE (EPOXY FILLED HOLE)
- T - THREADED INSERT
- P - ATTACHED JACKPOST
(PER M83513/05-07 OR -17)

POTTING CUP STYLE

(INCLUDES OR EXCLUDES PCB MOUNTING HARDWARE)

- 1 - W/THROUGH HOLES FOR APPLICABLE SIZE HARDWARE <1>
- 2 - W/APPLICABLE SIZE THREADED INSERTS INSTALLED <1>

SHELL FINISH (& MATERIAL)

- A - ANODIZE (ALUMINUM)
- C - CADMIUM (ALUMINUM)
- G - GOLD (ALUMINUM)
- N - ELECTROLESS NICKEL (ALUMINUM)
- S - PASSIVATION (STAINLESS STEEL)
- T - TIN (ALUMINUM)

- <1> - SIZES 9-51 USES #2-56, 100 USES #4-40 EXCEPT AS NOTED
- <2> - CURRENTLY ONLY AVAILABLE IN SIZES 9-51 (USES #2-56)
- <3> - HI-REL RECOMMENDS USE OF ANTI-SEIZE COMPOUND TO MAXIMIZE LIFE CYCLE
- <4> - ADDITIONAL SIZES MAY BE AVAILABLE. CONTACT FACTORY FOR CURRENT AVAILABILITY

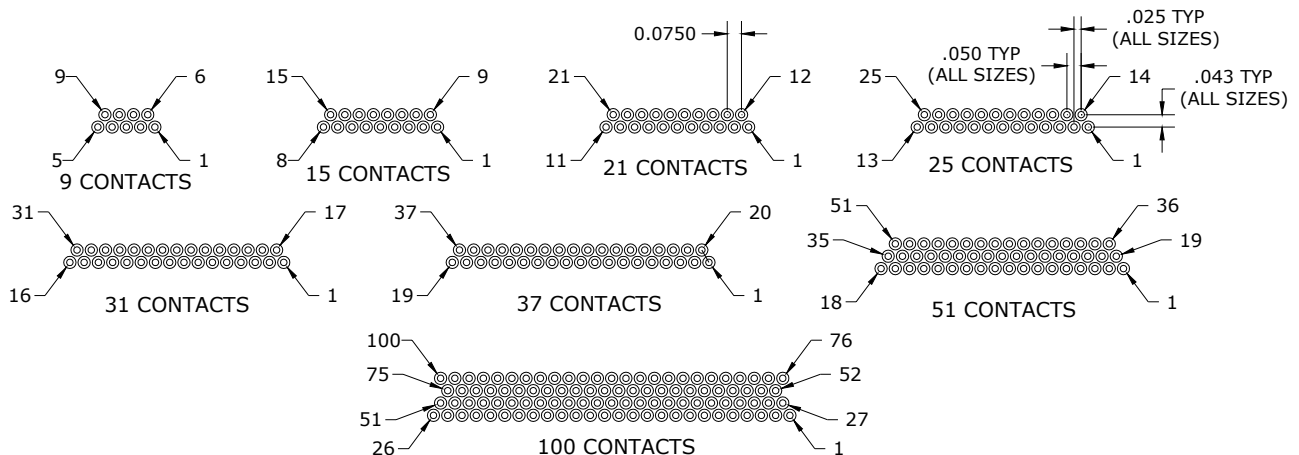

CONTACT ARRANGEMENTS

(FACE VIEW OF PIN INSERT SHOWN, REVERSE ORDER FOR SOCKET SIDE)

SEE THE FIRST PAGE OF THIS SECTION FOR PERFORMANCE, MATERIAL, AND PLATING INFORMATION

MICROMINIATURE – COTS MICRO-D CONNECTORS HDM10 THRU 15 – RIGHT ANGLE PC BOARD TERMINATION

SIZE	A MAX.	B NOM.	C ±.010 [±.25]	D ±.010 [±.25]	E MAX.
9	.785 [19.94]	.565 [14.35]	.230 [5.81]	.250 [6.35]	.420 [10.57]
15	.935 [23.75]	.715 [18.16]	.130 [3.30]	.250 [6.35]	.420 [10.57]
21	1.085 [27.56]	.865 [21.97]	.130 [3.30]	.250 [6.35]	.420 [10.57]
25	1.185 [30.10]	.965 [24.51]	.130 [3.30]	.250 [6.35]	.420 [10.57]
31	1.335 [33.91]	1.115 [28.32]	.130 [3.30]	.250 [6.35]	.520 [13.21]
37	1.485 [37.72]	1.265 [32.13]	.130 [3.30]	.250 [6.35]	.520 [13.21]
51	1.435 [36.45]	1.215 [30.86]	.150 [3.81]	.300 [7.62]	.650 [16.15]
100	2.170 [55.12]	1.800 [45.72]	.200 [5.08]	.400 [10.16]	1.010 [25.65]

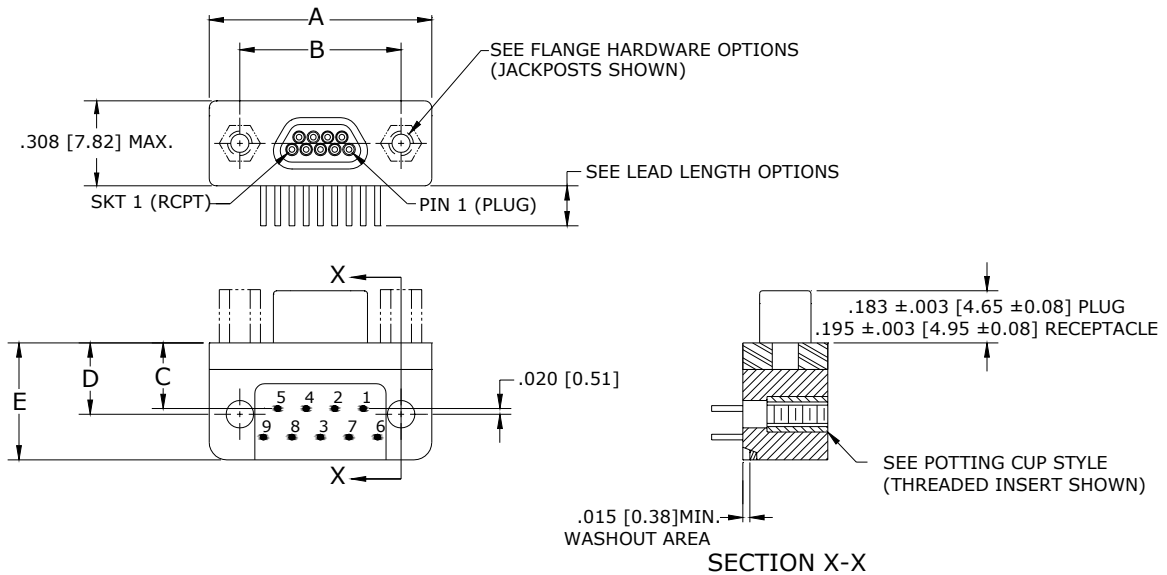

SIZES 9 - 37
(SIZE 9 PLUG (PIN CONTACTS) SHOWN)

DIMENSIONS ARE IN INCHES [MILLIMETERS], TOLERANCE UNLESS OTHERWISE NOTED IS ±.005 [0.13]



MICROMINIATURE – COTS MICRO-D CONNECTORS

HDM10 THRU 15 – RIGHT ANGLE PC BOARD TERMINATION

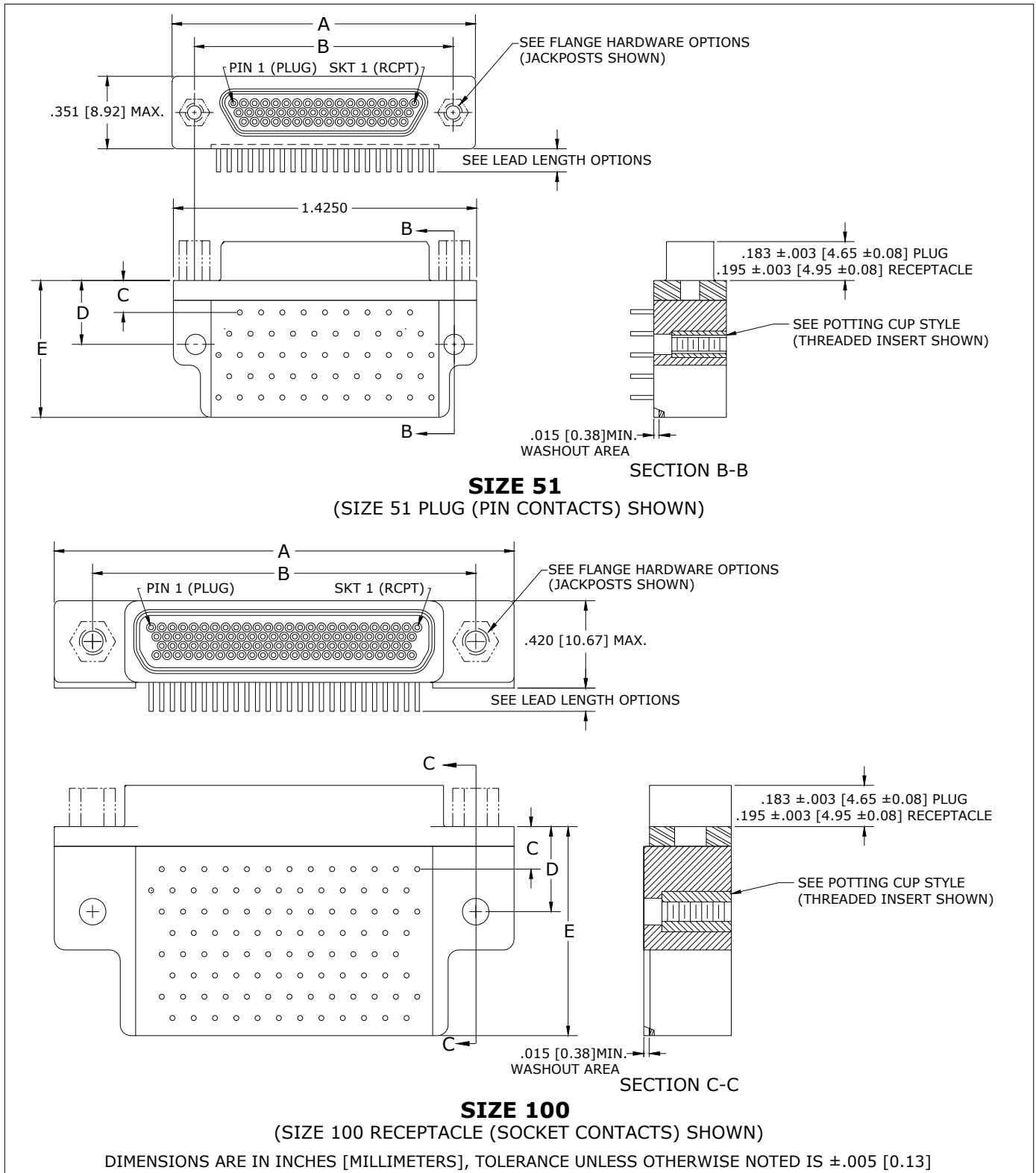



MICROMINIATURE – COTS MICRO-D CONNECTORS HDM10 THRU 15 – RIGHT ANGLE PC BOARD TERMINATION

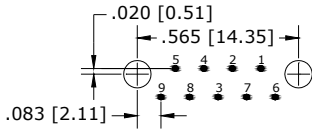

SIZE 9

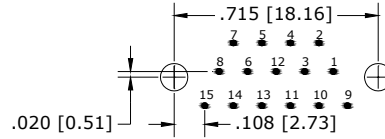

SIZE 15

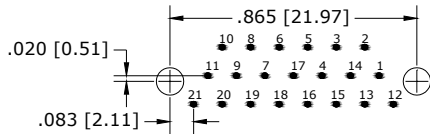

SIZE 21

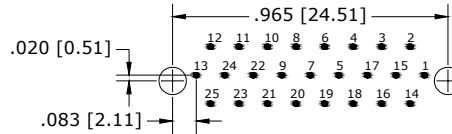

SIZE 25

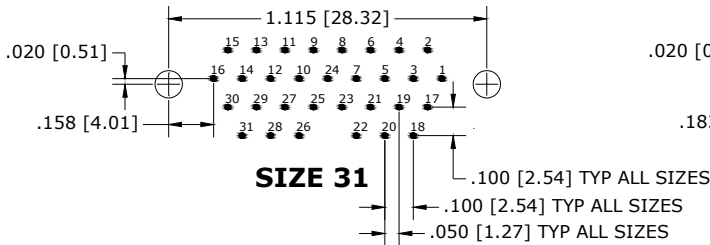

SIZE 31

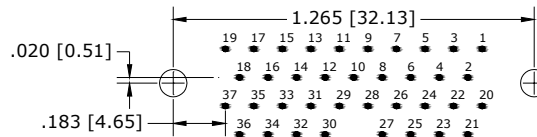

SIZE 37

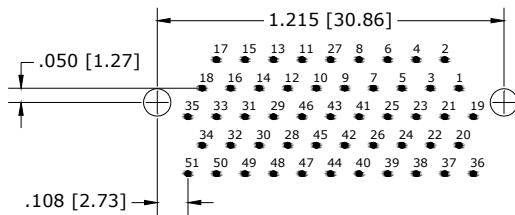

SIZE 51

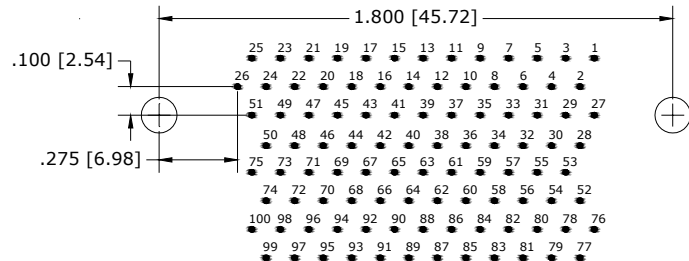

SIZE 100

**PLUG (PIN CONTACTS)
PCB TERMINATION ARRANGEMENTS**
(SHOWN FROM BOTTOM OF CONNECTOR, SOLDER SIDE OF PCB.)

DIMENSIONS ARE IN INCHES [MILLIMETERS], TOLERANCE UNLESS OTHERWISE NOTED IS $\pm .005$ [0.13]



MICROMINIATURE – COTS MICRO-D CONNECTORS HDM10 THRU 15 – RIGHT ANGLE PC BOARD TERMINATION

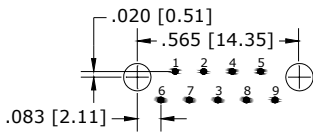

SIZE 9

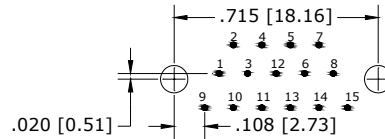

SIZE 15

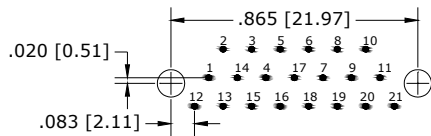

SIZE 21

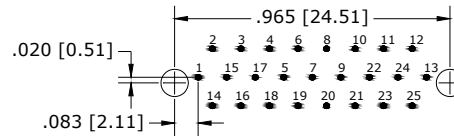

SIZE 25

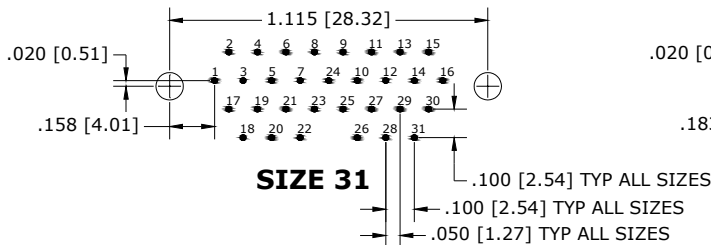

SIZE 31

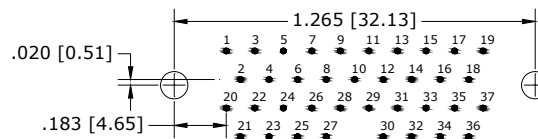

SIZE 37

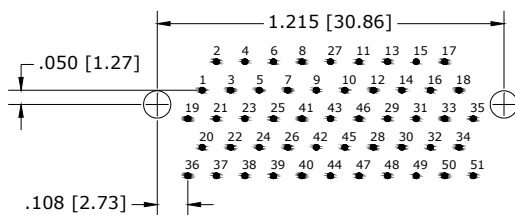

SIZE 51

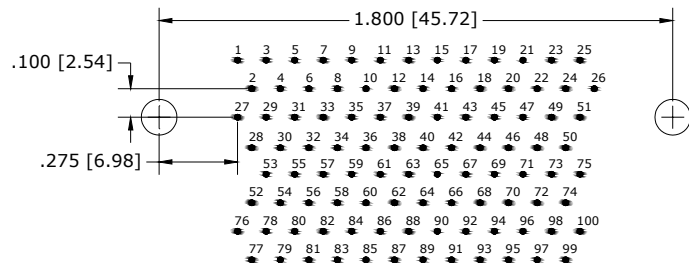

SIZE 100

**RECEPTACLE (SOCKET CONTACTS)
PCB TERMINATION ARRANGEMENTS**
(SHOWN FROM BOTTOM OF CONNECTOR, SOLDER SIDE OF PCB.)

DIMENSIONS ARE IN INCHES [MILLIMETERS], TOLERANCE UNLESS OTHERWISE NOTED IS $\pm .005$ [0.13]