

REMOTE CONTROL TRANSMITTER

FEATURES SUMMARY

- FLASHED OR MODULATED TRANSMISSION
- 7 SUB-SYSTEM ADDRESSES
- UP TO 64 COMMANDS PER SUB-SYSTEM ADDRESS
- HIGH-CURRENT REMOTE OUTPUT AT $V_{DD} = 6V$ ($-I_{OH} = 80mA$)
- LOW NUMBER OF ADDITIONAL COMPONENTS
- KEY RELEASE DETECTION BY TOGGLE BITS
- VERY LOW STAND-BY CURRENT ($< 2\mu A$)
- OPERATIONAL CURRENT $< 1mA$ AT 6V SUPPLY
- SUPPLY VOLTAGE RANGE 2 TO 6.5V
- CERAMIC RESONATOR CONTROLLED FREQUENCY (typ. 450kHz)

DESCRIPTION

The M3004LD transmitter IC is designed for infrared remote control systems. It has a total of 448 commands which are divided into 7 sub-system groups with 64 commands each. The sub-system code may be selected by a press button, a slider switch or hard wired.

The M3004LD generates the pattern for driving the output stage. These patterns are pulse distance coded. The pulses are infrared flashes or modulated. The transmission mode is defined in conjunction with the sub-system address. Modulated pulses allow receivers with narrow-band preamplifiers for improved noise rejection to be used. Flashed pulses require a wide-band preamplifier within the receiver.

Figure 1. Package

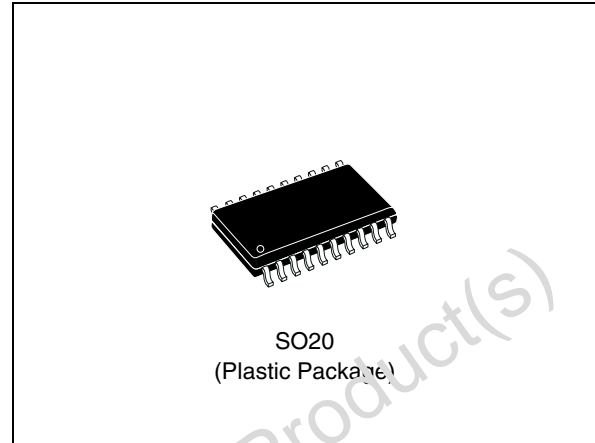

Figure 2. Pin Connection

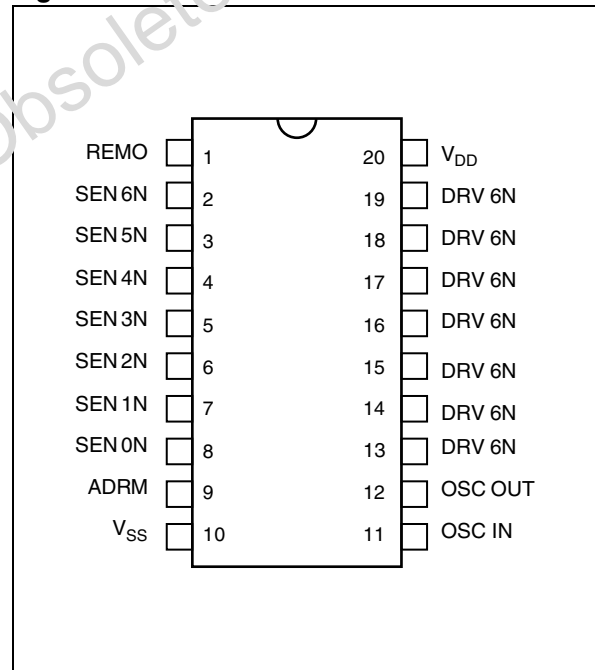
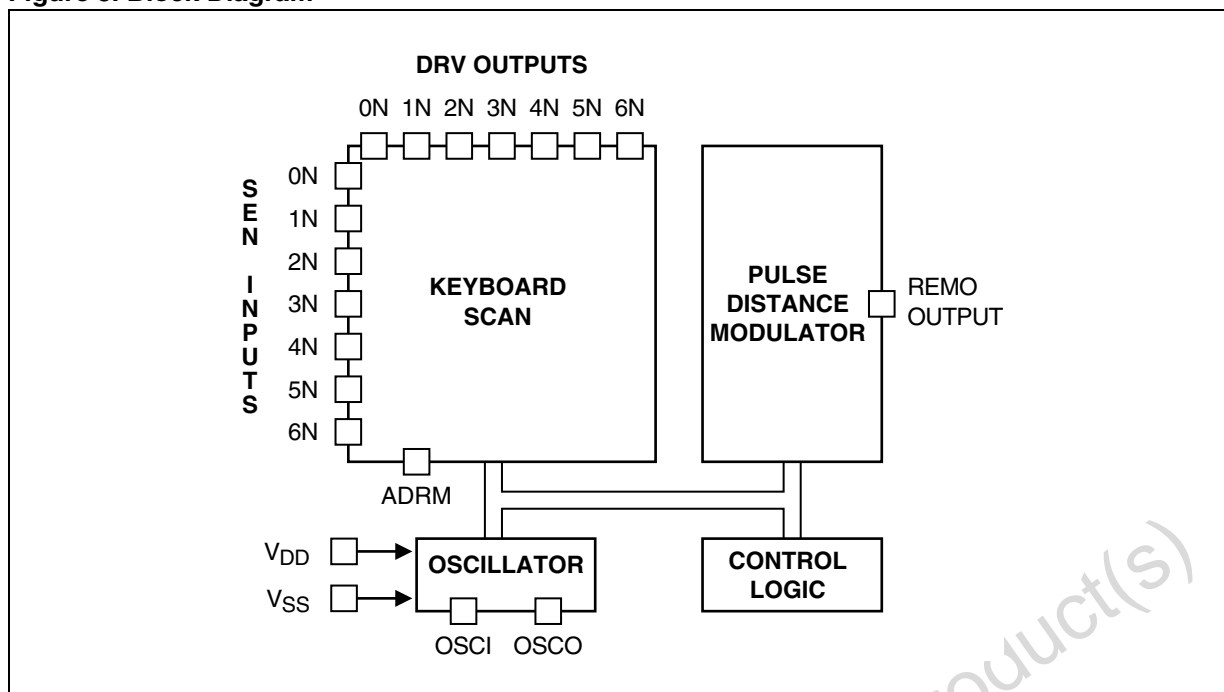

Figure 3. Block Diagram



INPUTS AND OUTPUTS

Key matrix inputs and outputs (DRV0N to DRV6N and SEN0N to SEN6N)

The transmitter keyboard is arranged as a scanned matrix. The matrix consists of 7 driver outputs and 7 sense inputs as shown in Figure 4. The driver outputs DRV0N to DRV6N are open drain N-channel transistors and they are conductive in the stand-by mode. The 7 sense inputs (SEN0N to SEN6N) enable the generation of 56 command codes. With 2 external diodes all 64 commands are addressable. The sense inputs have P-channel pull-up transistors so that they are HIGH until they are pulled LOW by connecting them to an output via a key depression to initiate a code transmission.

ADDRESS MODE INPUT (ADRM)

The sub-system address and the transmission mode are defined by connecting the ADRM input to one or more driver outputs (DRV0N to DRV6N) of the key matrix. If more than one driver is connected to ADRM, they must be decoupled by diodes. This allows the definition of seven sub-system addresses as shown in Table 3. If driver DRV6N is connected to ADRM, the data output

format of REMO is modulated or if not connected, flashed.

The ADRM input has switched pull-up and pull-down loads. In the stand-by mode only the pull-down device is active. Whether ADRM is open (sub-system address 0, flashed mode) or connected to the driver outputs, this input is LOW and will not cause unwanted dissipation. When the transmitter becomes active by pressing a key, the pull-down device is switched off and the pull-up device is switched on, so that the applied driver signals are sensed for the decoding of the sub-system address and the mode of transmission.

The arrangement of the sub-system address coding is such that only the driver DRVnM with the highest number (n) defines the sub-system address, e.g. if drivers DRV2N and DRV4N are connected to ADRM, only DRV4N will define the sub-system address. This option can be used in systems requiring more than one sub-system address. The transmitter may be hard-wired for subsystem address 2 by connecting DRV1N to ADRM. If now DRV3N is added to ADRM by a key or a switch, the transmitted sub-system address changes to 4. A change of the sub-system address will not start a transmission.

REMOTE CONTROL SIGNAL OUTPUT (REMO)

The REMO signal output stage is a push-pull type. In the HIGH state, a bipolar emitter-follower allows a high output current. The timing of the data output format is listed in Table 1 and 2. The information is defined by the distance t_b between the leading edges of the flashed pulses or the first edge of the modulated pulses (see Figure 6). The format of the output data is given in Figure 5 and 6. The data word starts with two toggle bits T1 and T0, followed by three bits for defining the sub-system address S2, S1 and S0, and six bits F, E, D, C, Band A which are defined by the selected key.

In the modulated transmission mode the first toggle bit is replaced by a constant reference time bit (REF). This can be used as a reference time for the decoding sequence. The toggle bits function is an indication for the decoder that the next instruction has to be considered as a new command. The codes for the sub-system address and the selected key are given in Table 3 and 4.

The REMO output is protected against "Lock-up", i.e. the length of an output pulse is limited to <1ms, even if the oscillator stops during an output pulse.

This avoids the rapid discharge of the battery that would otherwise be caused by the continuous activation of the LED.

OSCILLATOR INPUT / OUTPUT

(OSCI and OSCO)

The external components must be connected to these pins when using an oscillator with a ceramic resonator. The oscillator frequency may vary between 350kHz and 600kHz as defined by the resonator.

FUNCTIONAL DESCRIPTION

Keyboard operation

In the stand-by mode all drivers (DRV0N to DRV6N) are on (low impedance to V_{SS}). When ever a key is pressed, one or more of the sense inputs (SENnN) are tied to ground. This will start the power-up sequence. First the oscillator is activated and after the debounce time t_{DB} (see Figure 7) the output drivers (DRV0N to DRV6N) become active successively.

Within the first scan cycle the transmission mode, the applied sub-system address and the selected command code are sensed and loaded into an internal data latch.

In contrast to the command code, the sub-system is sensed only within the first scan cycle. If the applied sub-system address is changed while the command key is pressed, the transmitted sub-system address is not altered.

In a multiple key stroke sequence (see Figure 8) the command code is always altered in accordance with the sensed key.

MULTIPLE KEY-STROKE PROTECTION

The keyboard is protected against multiple key-strokes. If more than one key is pressed at the same time, the circuit will not generate a new output at REMO (see Figure 8). In case of a multiple key-stroke, the scan repetition rate is increased to detect the release of a key as soon as possible.

There are two restrictions caused by the special structure of the keyboard matrix:

- The keys switching to ground (code numbers 7, 15, 23, 31, 39, 47, 55 and 63) and the keys connected to SEN5N and SEN6N are not covered completely by the multiple key protection. If one sense input is switched to ground, further keys on the same sense line are ignored, i.e. the command code corresponding to "key to ground" is transmitted.
- SEN5N and SEN6N are not protected against multiple keystroke on the same driver line, because this condition has been used for the definition of additional codes (code number 56 to 63).

OUTPUT SEQUENCE (data format)

The output operation will start when the selected code is found. A burst of pulses, including the latched address and command codes, is generated at the output REMO as long as a key is pressed.

The format of the output pulse train is given in Figure 5 and 6. The operation is terminated by releasing the key or if more than one key is pressed at the same time. Once a sequence is started, the transmitted data words will always be completed after the key is released.

The toggle bits T0 and T1 are incremented if the key is released for a minimum time t_{REL} (see Figure 7). The toggle bits remain unchanged within a multiple key-stroke sequence.

Table 1. Pulse Train Timing

| Mode | T _O (ms) | t _P (μs) | t _M (μs) | t _{ML} (μs) | t _{MH} (μs) | t _W (ms) |
|------------------|--------------------------|------------------------------|---------------------|----------------------|----------------------|---------------------|
| Flashed | 2.53 | 8.8 | - | - | - | 121 |
| Modulated | 2.53 | - | 26.4 | 17.6 | 8.8 | 121 |
| f _{OSC} | 455kHz | t _{OSC} = 2.2ms | | | | |
| t _P | 4 x t _{OSC} | Flashed Pulse Width | | | | |
| t _M | 12 x t _{OSC} | Modulation Period | | | | |
| t _{ML} | 8 x t _{OSC} | Modulation Period Low | | | | |
| t _{MH} | 4 x t _{OSC} | Modulation Period High | | | | |
| t _W | 55296 x t _{OSC} | Word Distance | | | | |
| T _O | 1152 x t _{OSCb} | Basic Unit of Pulse Distance | | | | |

Note: The following number of pulses may be selected by Metal option: N= 8, 12, 16.

The different dividing ratio for T_O and t_W between flash mode and carrier mode is obtained by changing the modulo of a particular divider from divide by 3 during flash mode to divide by 4 during carrier mode. This allows the use of a 600kHz ceramic resonator during carrier mode to obtain a better noise immunity for the receiver without a significant change in T_O and t_W. For first samples, the correct divider ration is obtained by a metal mask option. For final parts, this is automatically done together with the selection of flash-/carrier mode.

Table 2. Pulse Train Separation (t_b)

| Code | t _b |
|-----------------|--|
| Logic "0" | 2 x T _O |
| Logic "1" | 3 x T _O |
| Toggle Bit Time | 2 x T _O or 3 x T _O |
| Reference Time | 3 x T _O |

Table 3. Transmission Mode and Sub-system Address Selection

| Mode | Sub-system Address | | | | Driver DRVnN for n = | | | | | | |
|---|---------------------------------|----------------------------|----------------------------|----------------------------|--------------------------------|-------------------------------|------------------------------|-----------------------------|----------------------------|---------------------------|------------------------------------|
| | # | S2 | S1 | S0 | 0 | 1 | 2 | 3 | 4 | 5 | 6 |
| F L A S H E D | 0 1 2 3 4 5 6 | 1 0 0 0 1 1 | 1 0 0 1 0 0 | 1 0 1 1 0 1 | O X X X X X | O X X X X | O X X X | O X X | O X | O | |
| M O D U L A T E D | 0 1 2 3 4 5 6 | 1 0 0 0 1 1 | 1 0 0 1 1 0 | 1 0 1 1 0 1 | O X X X X X | O X X X X | O X X X | O X X | O X | O | O O O O O O |

Note: O = connected to ADRM
blank = not connected to ADRM
X = don't care

Table 4. Key codes

| Matrix Drive | Matrix Sense | Code | | | | | | Matrix Position |
|--------------|-----------------|------|---|---|--------|---|---|-----------------|
| | | F | E | D | C | B | A | |
| DRV0N | SEN0N | 0 | 0 | 0 | 0 | 0 | 0 | 0 |
| DRV1N | SEN0N | 0 | 0 | 0 | 0 | 0 | 1 | 1 |
| DRV2N | SEN0N | 0 | 0 | 0 | 0 | 1 | 0 | 2 |
| DRV3N | SEN0N | 0 | 0 | 0 | 0 | 1 | 1 | 3 |
| DRV4N | SEN0N | 0 | 0 | 0 | 1 | 0 | 0 | 4 |
| DRV5N | SEN0N | 0 | 0 | 0 | 1 | 0 | 1 | 5 |
| DRV6N | SEN0N | 0 | 0 | 0 | 1 | 1 | 0 | 6 |
| VSS | SEN0N | 0 | 0 | 0 | 1 | 1 | 1 | 7 |
| Note 1 | SEN1N | 0 | 0 | 1 | Note 2 | | | 8 to 15 |
| Note 1 | SEN2N | 0 | 1 | 0 | Note 2 | | | 16 to 23 |
| Note 1 | SEN3N | 0 | 1 | 1 | Note 2 | | | 24 to 31 |
| Note 1 | SEN4N | 1 | 0 | 0 | Note 2 | | | 32 to 39 |
| Note 1 | SEN5N | 1 | 0 | 1 | Note 2 | | | 40 to 47 |
| Note 1 | SEN6N | 1 | 1 | 0 | Note 1 | | | 48 to 55 |
| Note 1 | SEN5N and SEN6N | 1 | 1 | 1 | Note 2 | | | 56 to 63 |

Note: 1. The complete matrix drive as shown above for SEN0N is also applicable for the matrix sense inputs SEN1N to SEN6N and the combined SEN5/SEN6N.
2. The C, B and A codes are identical to SEN0N as given above.

Table 5. Absolute Maximum Ratings ($T_{\text{case}} = 25^{\circ}\text{C}$)

| Symbol | Parameter | Value | Unit |
|------------------------------|---|-----------------------------------|--------------------|
| V_{DD} | Supply Voltage Range | -0.3 to +7 | V |
| V_{I} | Input Voltage Range | -0.3 to ($V_{\text{DD}} + 0.3$) | V |
| V_{O} | Output Voltage Range | -0.3 to ($V_{\text{DD}} + 0.3$) | V |
| $\pm I$ | D.C. Current into Any Input or Output | Max 10 | mA |
| $-I(\text{REMO})_{\text{M}}$ | Peak REMO Output Current during 10 μs , Duty Factor = 1% | Max 300 | mA |
| P_{TOT} | Power Dissipation per Package for $T_{\text{A}} = -20$ to $+70^{\circ}\text{C}$ | Max 200 | mW |
| T_{STG} | Storage Temperature Range | -55 to +125 | $^{\circ}\text{C}$ |
| T_{A} | Operating Ambient Temperature Range | -20 to +70 | $^{\circ}\text{C}$ |

Note: Stresses in excess of those listed under "Absolute Maximum Ratings" may cause permanent damage to the device. This is a stress rating only and functional operation of the device at these or any other conditions in excess of those indicated in the operational sections of this specification is not implied. Exposure to absolute maximum rating conditions for extended periods may affect device reliability.

Obsolete Product(s) - Obsolete Product(s)

ELECTRICAL CHARACTERISTICS $V_{SS} = 0V$, $T_A = 25^\circ C$ (unless otherwise specified)**Table 6.**

| Symbol | Parameter | Test Conditions | Min | Typ | Max | Unit |
|--|--|--|---|-------------|---------------------|--------------------|
| V_{DD} | Supply Voltage | $T_A = 0$ to $+70^\circ C$ | 2 | | 6.5 | V |
| I_{DD} | Supply Current | • Active $f_{OSC} = 455kHz$ REMO, Output unload | | 0.25 1.0 | 0.5 2 | mA mA |
| | | • Inactive (stand-by mode) | $V_{DD} = 3V$ $V_{DD} = 6V$ $V_{DD} = 6V$ | | 2 | μA |
| f_{OSC} | Oscill. Frequency | $V_{DD} = 2$ to $6.5V$ (cer resonator) | 350 | | 600 | kHz |
| KEYBOARD MATRIX - Inputs SE0N to SEN6N | | | | | | |
| V_{IL} | Input Voltage Low | $V_{DD} = 2$ to $6.5V$ | | | $0.3 \times V_{DD}$ | V |
| V_{IH} | Input Voltage High | $V_{DD} = 2$ to $6.5V$ | $0.7 \times V_{DD}$ | | | V |
| $-I_I$ | Input Current | $V_{DD} = 2V$, $V_I = 0V$ $V_{DD} = 6.5V$, $V_I = 0V$ | 10 100 | | 100 600 | μA μA |
| I_I | Input Leakage Current | $V_{DD} = 6.5V$, $V_I = V_{DD}$ | | | 1 | μA |
| KEYBOARD MATRIX - Outputs DRV0N to DRV6N | | | | | | |
| V_{OL} | Output Voltage "ON" | $V_{DD} = 2V$, $I_O = 0.1mA$ $V_{DD} = 6.5V$, $I_O = 2.5mA$ | | | 0.3 0.6 | V V |
| I_O | Output Current "OFF" | $V_{DD} = 6.5V$, $V_O = 11V$ | | | 10 | μA |
| CONTROL INPUT ADRM | | | | | | |
| V_{IL} | Input Voltage Low | | | | $0.3 \times V_{DD}$ | V |
| V_{IH} | Input Voltage High | | $0.7 \times V_{DD}$ | | | V |
| I_{IL} | Input Current Low (switched P and N channel pull-up/pull down) | Pull-up Act. Oper. Condition, $V_{IN} = V_{SS}$ $V_{DD} = 2V$ $V_{DD} = 6.5V$ | 10 100 | | 100 600 | μA μA |
| I_{IH} | Input Current High (switched P and N channel pull-up/pull down) | Pull-down Act. Stand-by Cond., $V_{IN} = V_{DD}$ $V_{DD} = 2V$ $V_{DD} = 6.5V$ | 10 100 | | 100 600 | μA μA |
| DATA OUTPUT REMO | | | | | | |
| $-I_{OH}$ | Output Current High | $V_{DD} = 2V$, $V_{OH} = 0.8V$ $V_{DD} = 6.5V$, $V_{OH} = 5V$ | 60 80 | | | mA mA |
| I_{OL} | Output Current Low | $V_{DD} = 2V$, $V_{OL} = 0.4V$ $V_{DD} = 6.5V$, $V_{OL} = 0.4V$ | | | 0.6 0.6 | mA mA |
| t_{OH} | Pulse Length | $V_{DD} = 6.5V$, Oscill. Stopped | | | 1 | ms |
| OSCILLATOR | | | | | | |
| I_I | Input Current | $V_{DD} = 2V$ $V_{DD} = 6.5V$, OSC1 at V_{DD} | 5 | | 5 7 | μA μA |
| V_{OH} | Output Voltage high | $V_{DD} = 6.5V$, $-I_{OL} = 0.1mA$ | $V_{DD} - 0.8$ | | | V |
| V_{OL} | Output Voltage Low | $V_{DD} = 6.5V$, $I_{OH} = 0.1mA$ | | | 0.7 | V |

Figure 4. Typical Application

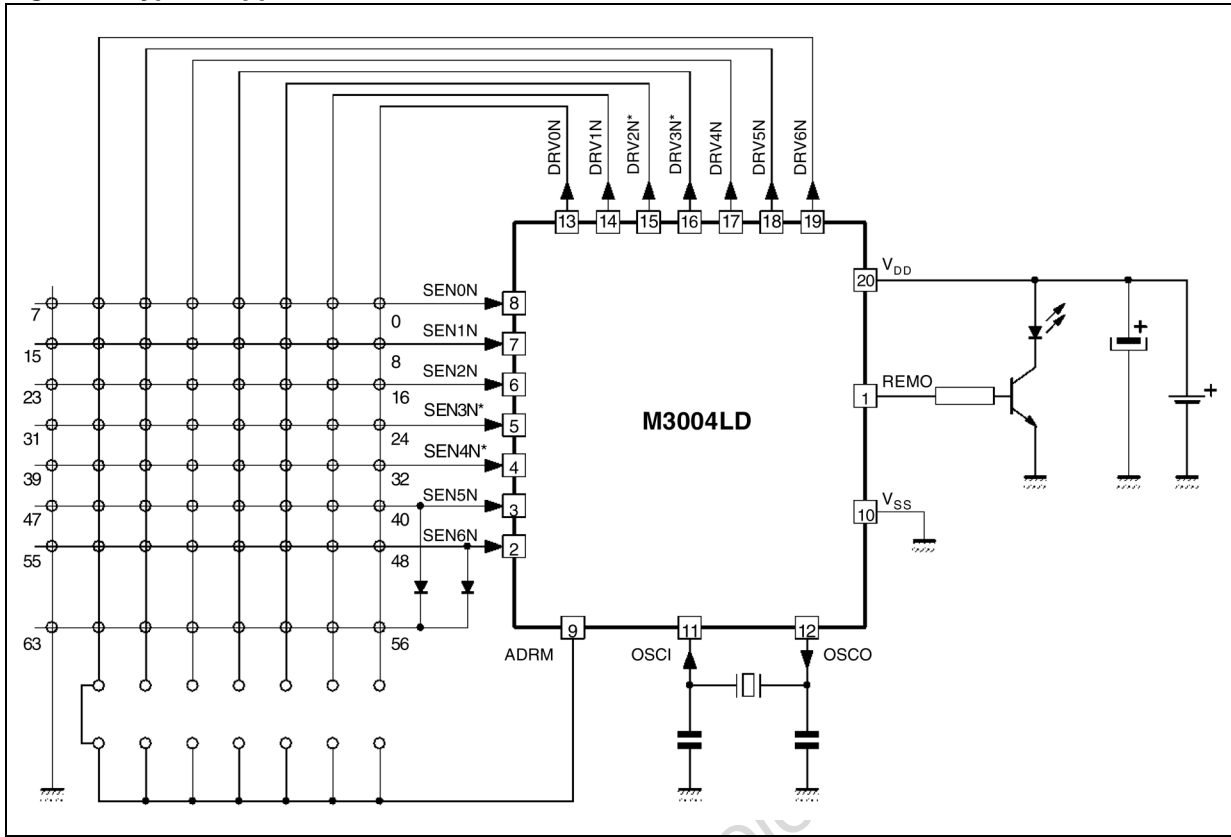
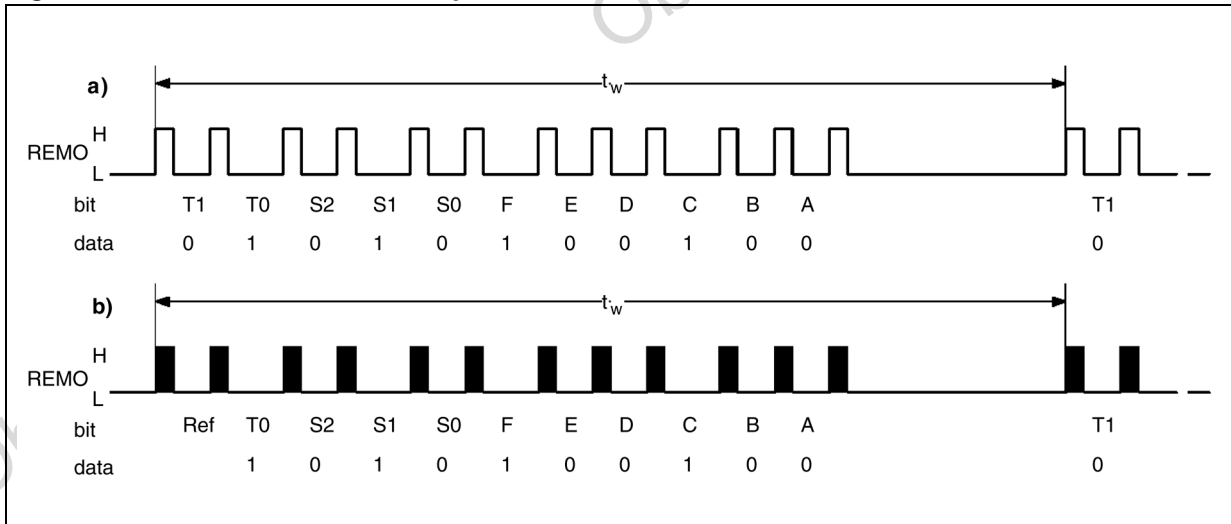
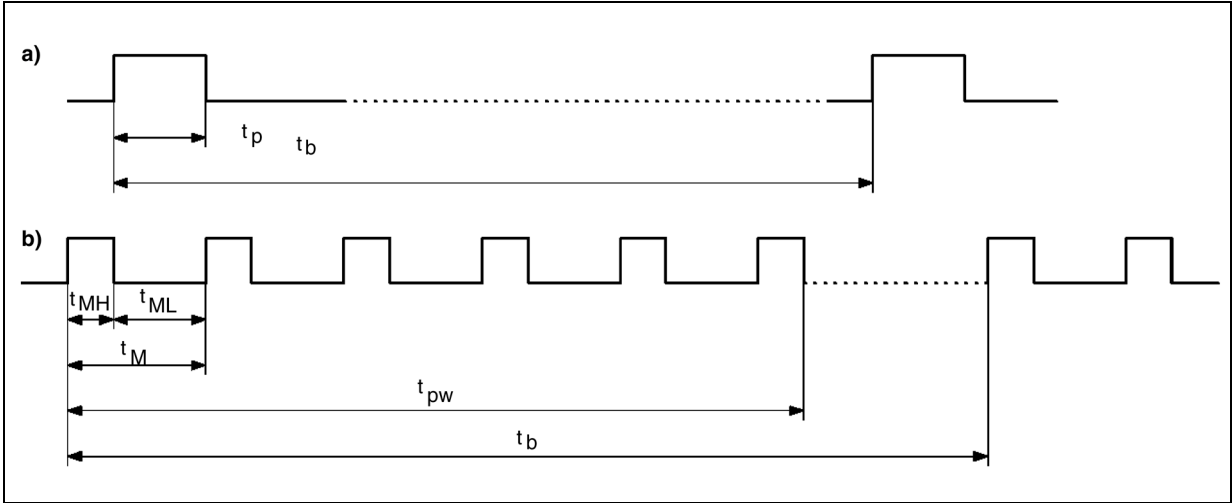

Figure 5. Data Format of REMO Output



Note: REF = Reference Time; T0 and T1 = Toggle bits; S0, S1 and S2 = System address; A, B, C, D, E and F = Command bits.
 (a) flashed mode: transmission with 2 toggle bits and 3 address bits, followed by 6 command bits (pulses are flashed)
 (b) modulated mode: transmission with reference time, 1 toggle bit and 3 address bits, followed by 6 command bits (pulses are modulated)

Figure 6. REMO Output Waveform



Note: (a) flashed pulse
 (b) modulated pulse [$t_{pw} = (5 \times t_M) + t_{MH}$]

Figure 7. Single Key - Stroke Sequence

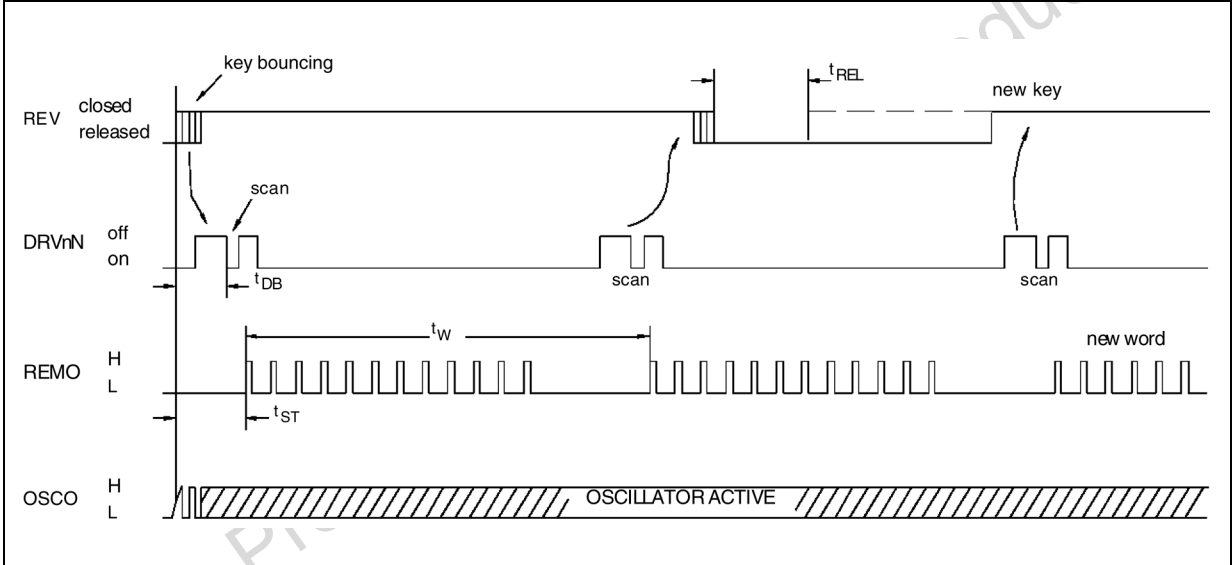

Note: Debounce time: $t_{DB} = 4$ to $9 \times T_O$
 Start time: $t_{ST} = 5$ to $10 \times T_O$
 Minimum release time: $t_{REL} = T_O$

Figure 8. Multiple Key-Stroke Sequence

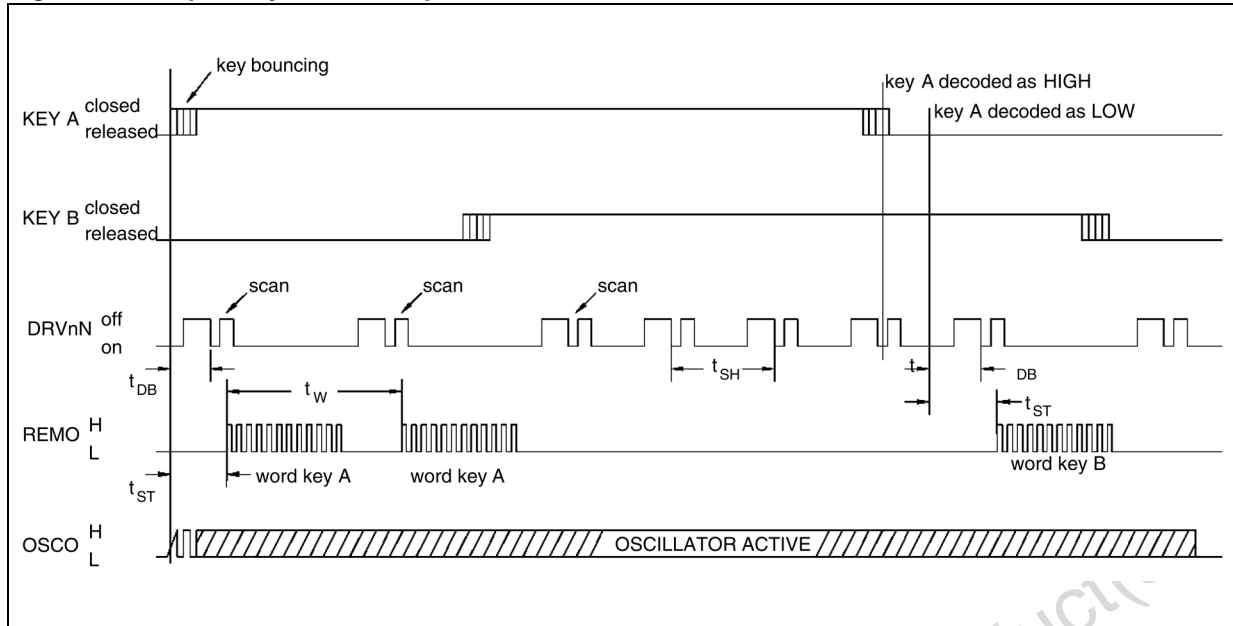

Note: Scan rate multiple key-stroke : $t_{SM} = 8 \text{ to } 10 \times T_O$

Obsolete Product(s) - Obsolete Product(s)

PART NUMBERING**Table 7. Order Codes**

| Order Codes | Package | Operative Temperature Range |
|-------------|---------|-----------------------------|
| M3004LD | SO20 | -20 to +70°C |
| M3004LDT | SO20 | -20 to +70°C |

Obsolete Product(s) - Obsolete Product(s)

PACKAGE MECHANICAL

Table 8. 20 PINS - PLASTIC MICROPACKAGE Mechanical Data

| Symbol | millimeters | | | inches | | |
|--------|-------------|-------|-------|--------|-------|-------|
| | Min | Typ | Max | Min | Typ | Max |
| A | | | 2.65 | | | 0.104 |
| a1 | 0.1 | | 0.2 | 0.004 | | 0.008 |
| a2 | | | 2.45 | | | 0.096 |
| b | 0.35 | | 0.49 | 0.014 | | 0.019 |
| b1 | 0.23 | | 0.32 | 0.009 | | 0.013 |
| C | | 0.5 | | | 0.020 | |
| c1 | 45° (Typ) | | | | | |
| D | 12.6 | | 13.0 | 0.496 | | 0.510 |
| E | 10 | | 10.65 | 0.394 | | 0.419 |
| e | | 1.27 | | | 0.050 | |
| e3 | | 11.43 | | | 0.450 | |
| F | 7.4 | | 7.6 | 0.291 | | 0.300 |
| L | 0.5 | | 1.27 | 0.020 | | 0.050 |
| M | | | 0.75 | | | 0.030 |
| S | 8° (Max) | | | | | |

Figure 9. Package Dimensions

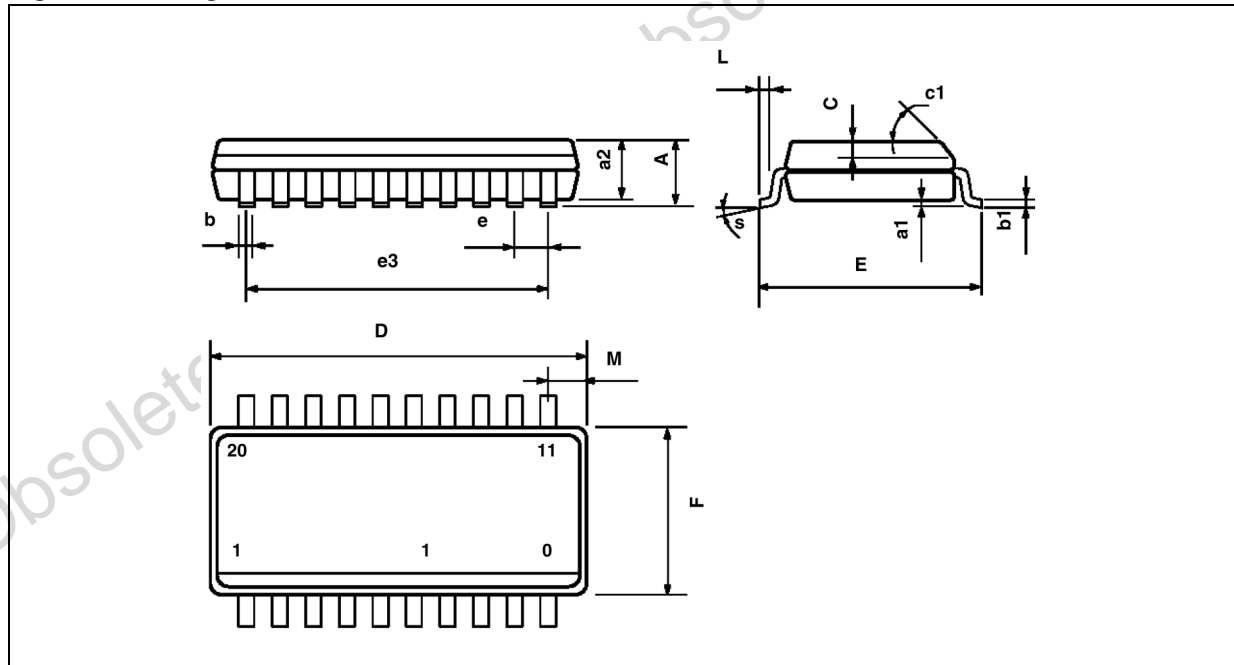

Note: Drawing is not to scale.

REVISION HISTORY**Table 9. Revision History**

| Date | Revision | Description of Changes |
|---------------|----------|---------------------------------------|
| November-1992 | 1 | First Issue |
| 28-June-2004 | 2 | Stylesheet update. No content change. |

Obsolete Product(s) - Obsolete Product(s)

Information furnished is believed to be accurate and reliable. However, STMicroelectronics assumes no responsibility for the consequences of use of such information nor for any infringement of patents or other rights of third parties which may result from its use. No license is granted by implication or otherwise under any patent or patent rights of STMicroelectronics. Specifications mentioned in this publication are subject to change without notice. This publication supersedes and replaces all information previously supplied. STMicroelectronics products are not authorized for use as critical components in life support devices or systems without express written approval of STMicroelectronics.

The ST logo is a registered trademark of STMicroelectronics.
All other names are the property of their respective owners

© 2004 STMicroelectronics - All rights reserved

STMicroelectronics GROUP OF COMPANIES

Australia - Belgium - Brazil - Canada - China - Czech Republic - Finland - France - Germany - Hong Kong - India - Israel - Italy - Japan -
Malaysia - Malta - Morocco - Singapore - Spain - Sweden - Switzerland - United Kingdom - United States

www.st.com