

LOW DROPOUT, NEGATIVE OUTPUT VOLTAGE REGULATOR

FEATURES

- Low Dropout Voltage (Typically 120mV at 50mA; 380mV at 100mA) for -5.0V Output Part
- Tight Output Voltage Tolerance ($\pm 2\%$, Max)
- Low Supply Current (3.5 μ A, Typ)
- Factory-Programmed Output Voltages of -2.1V to -6.0V in 100mV Increments
- Space-Saving 3-Pin SOT-23A Package

TYPICAL APPLICATIONS

- Cellular Phones
- Battery Operated Systems
- Palmtops
- Portable Cameras

TYPICAL APPLICATION

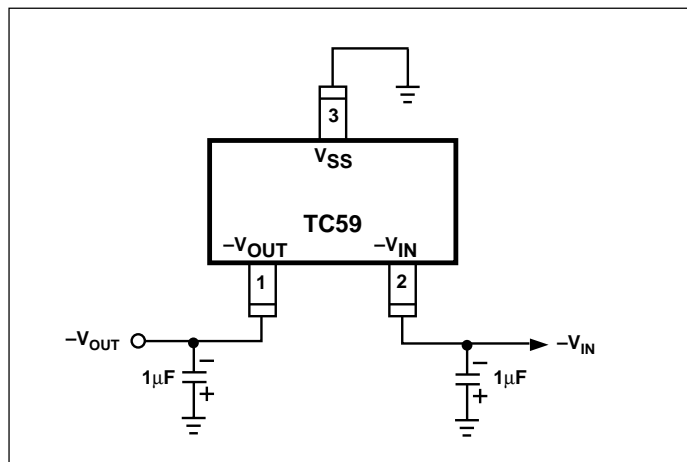

PIN CONFIGURATION

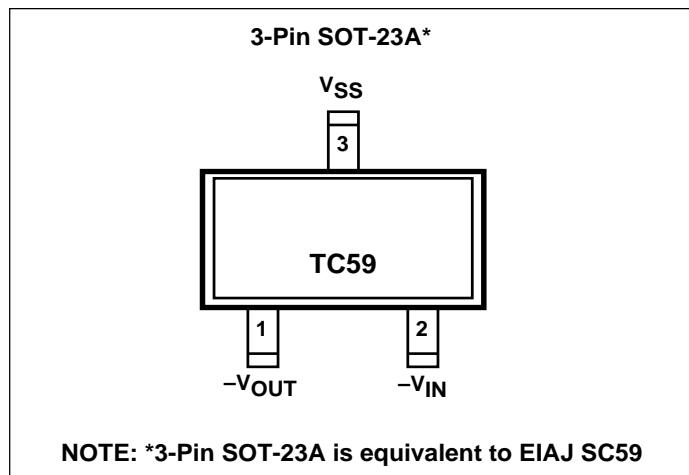

GENERAL DESCRIPTION

The TC59 is a low dropout, negative output voltage regulator designed specifically for battery-operated systems. Its full CMOS construction eliminates the wasted ground current typical of bipolar LDOs. This reduced supply current significantly extends battery life, particularly when the TC59 is operated in dropout.

Other TC59 key features include low supply current (typically 3.0 μ A) and low dropout operation (typically 120mV at 50mA). Factory-programmed output voltages of -2.1V to -6.0V in 100mV steps are available. The TC59 is packaged in a tiny 3-Pin SOT-23A package.

ORDERING INFORMATION

PART CODE	TC59	30	02	ECB	XX
	TC59	50	02	ECB	XX

Output Voltage: _____
Ex: 50 = -5.0V; 30 = -3.0V

Max Output Tolerance: _____
Ex: 02 = 2%; 01 = 1%

Package/Temperature _____
-40°C to $\pm 85^\circ$ C
3-Pin SOT-23A Package

Taping Direction: _____
TR = Standard
RT = Reverse

*Other voltages are available. Please contact Microchip Technology Inc. for details.

LOW DROPOUT, NEGATIVE OUTPUT VOLTAGE REGULATOR

TC59

ABSOLUTE MAXIMUM RATINGS*

Input Voltage (V_{IN})-12V
Output Current (I_{OUT})200mA
Output Voltage (V_{OUT}) $-V_{DD} - 0.3V$ to $V_{IN} + 0.3V$
Power Dissipation (P_d)150mW
Operating Ambient Temperature (T_{OPR})	.. $-40^{\circ}C$ to $+85^{\circ}C$
Storage Temperature (T_{STG}) $-40^{\circ}C$ to $+125^{\circ}C$

*Static-sensitive device. Unused devices must be stored in conductive material. Protect devices from static discharge and static fields. Stresses above those listed under Absolute Maximum Ratings may cause permanent damage to the device. These are stress ratings only and functional operation of the device at these or any other conditions above those indicated in the operational sections of the specifications is not implied. Exposure to Absolute Maximum Rating Conditions for extended periods may affect device reliability.

ELECTRICAL CHARACTERISTICS: $V_{IN} = V_R - 1.0V$; Note 1; $C_L = 10 \mu F$; $T_A = +25^{\circ}C$, unless otherwise specified.

Symbol	Parameter	Test Conditions	Min	Typ	Max	Unit
V_{IN}	Supply Voltage	$I_{OUT} = 20mA$	—	—	-10	V
I_{DD}	Supply Current		—	3	7	μA
$I_{OUT(MAX)}$	Maximum Output Current	$V_{IN} = -6.0V$; $V_R = -5.0V$, $V_{OUT} \leq -4.5V$ $V_{IN} = -5.0V$; $V_R = -4.0V$, $V_{OUT} \leq -3.6V$ $V_{IN} = -4.0V$; $V_R = -3.0V$, $V_{OUT} \leq -2.7V$	100 80 60	— — —	— — —	mA mA mA
V_{OUT}	Output Voltage	$I_{OUT} = 20mA$	$1.02 \times V_R$	—	$0.98 \times V_R$	V
TC V_{OUT}	Output Voltage Temperature Coefficient	$I_{OUT} = 20mA$	—	± 100	—	ppm/ $^{\circ}C$
$\Delta V_{OUT}/(\Delta V_{IN} \times V_{OUT})$	Line Regulation	$I_{OUT} = 20mA$; $V_R = -5.0V$; $-6.0 < V_{IN} < -10.0V$ $V_R = -4.0V$; $-5.0 < V_{IN} < -10.0V$ $V_R = -3.0V$; $-4.0 < V_{IN} < -10.0V$		0.1	0.3	%/V
ΔV_{OUT}	Load Regulation	$V_R = -5.0V$; $1mA < I_{OUT} < 50 mA$ $V_R = -4.0V$; $1mA < I_{OUT} < 45 mA$ $V_R = -3.0V$; $1mA < I_{OUT} < 40 mA$		40	80	mV
$V_{IN} - V_{OUT}$	Dropout Voltage	$V_R = -5.0V$; $I_{OUT} = 50mA$ $I_{OUT} = 100mA$ $V_R = -4.0V$; $I_{OUT} = 45mA$ $I_{OUT} = 90mA$ $V_R = -3.0V$; $I_{OUT} = 40mA$ $I_{OUT} = 80mA$	— — — — — —	120 380 120 380 120 380	300 600 300 600 300 600	mV mV mV mV mV mV

Notes: 1. V_R is the regulator output voltage setting. For example: $V_R = -2.5V, -3.6V, -4.0V, -2.7V, -3.0V, -3.3V, -5.0V$.

PIN DESCRIPTION

Pin Number	Name	Description
1	V_{OUT}	Regulated Voltage Output
2	V_{IN}	Supply Voltage Input
3	V_{SS}	Ground

LOW DROPOUT, NEGATIVE OUTPUT VOLTAGE REGULATOR

TC59

TYPICAL CHARACTERISTICS CURVES

1. OUTPUT VOLTAGE vs. OUTPUT CURRENT

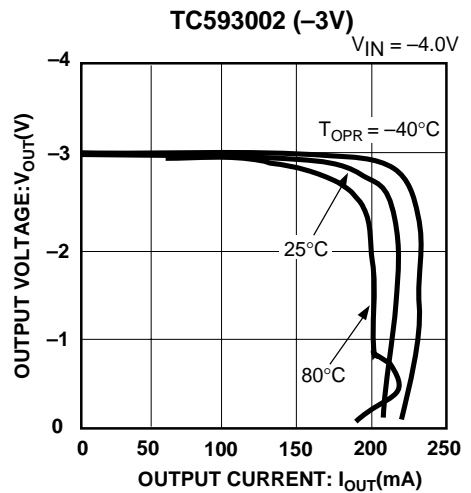
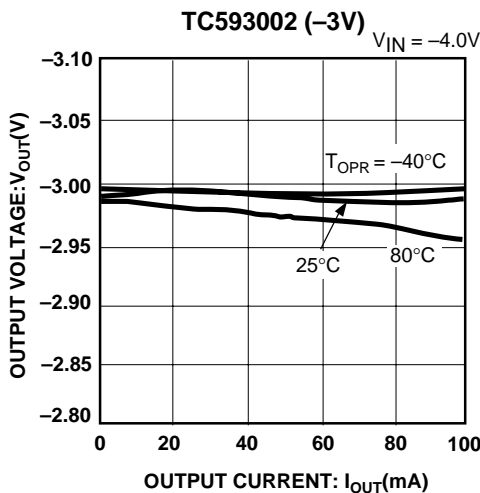
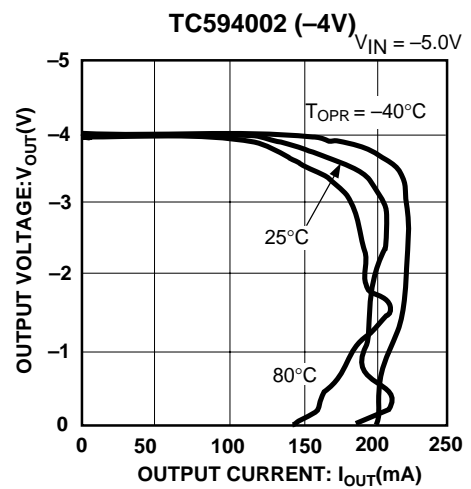
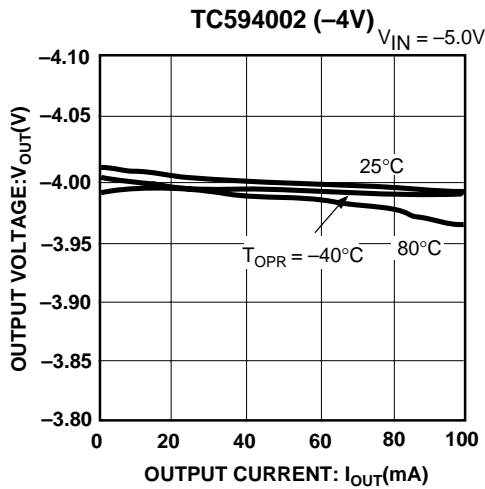
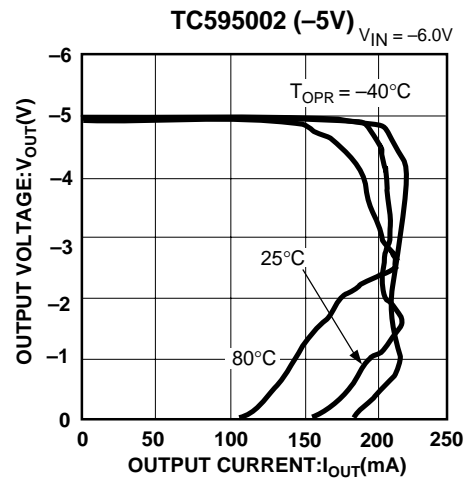
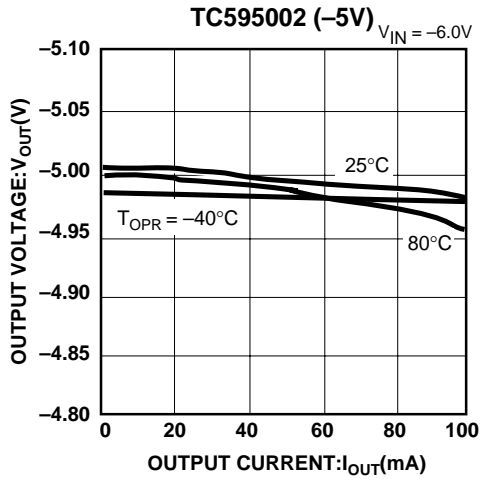

LOW DROPOUT, NEGATIVE OUTPUT VOLTAGE REGULATOR

TC59

TYPICAL CHARACTERISTICS CURVES (CONT.)

2. OUTPUT VOLTAGE vs. INPUT VOLTAGE

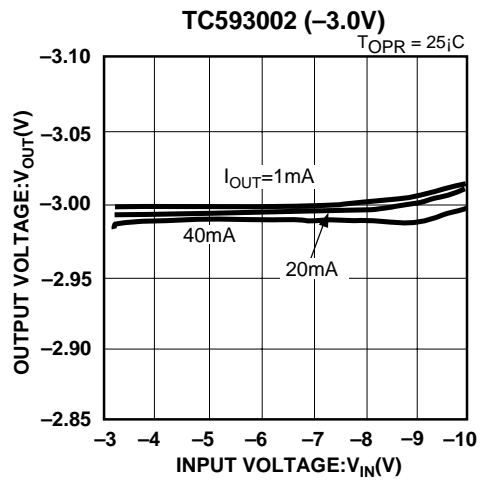
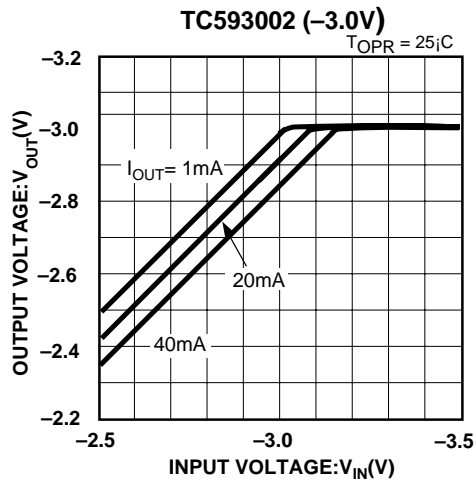
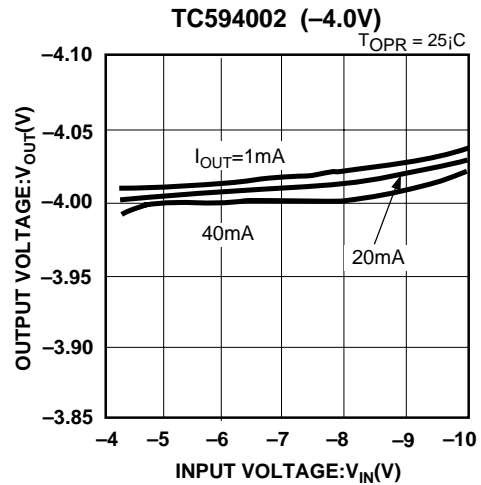
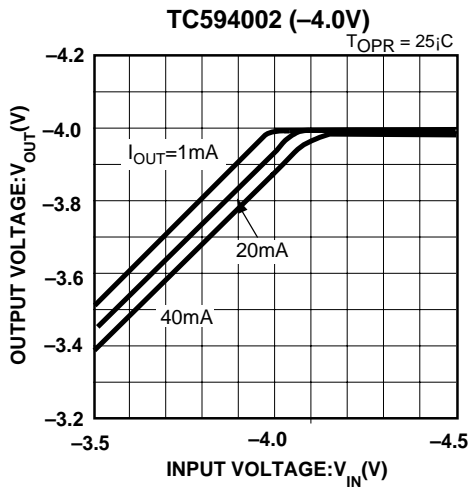
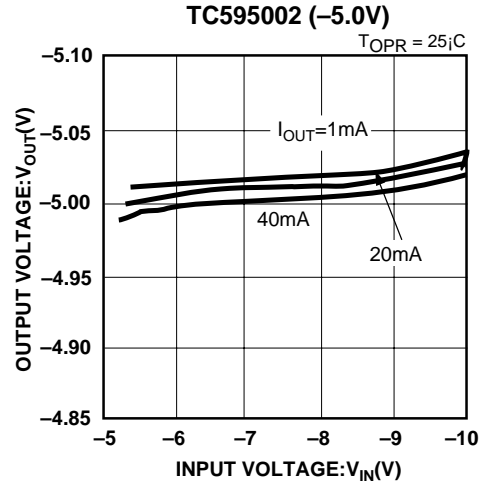
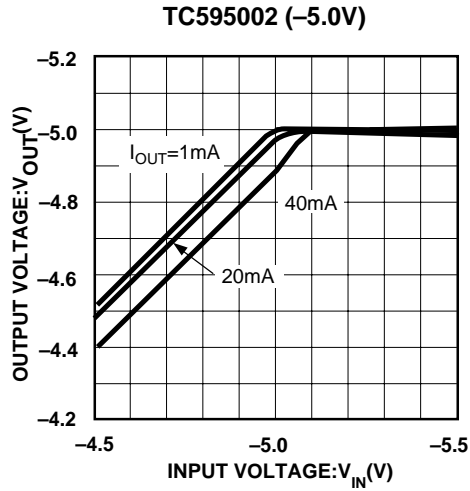

LOW DROPOUT, NEGATIVE OUTPUT VOLTAGE REGULATOR

TC59

TYPICAL CHARACTERISTICS CURVES (CONT.)

3. INPUT/OUTPUT VOLTAGE DIFFERENTIAL vs. OUTPUT CURRENT

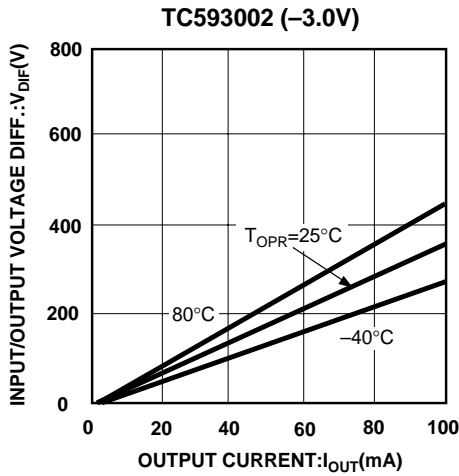
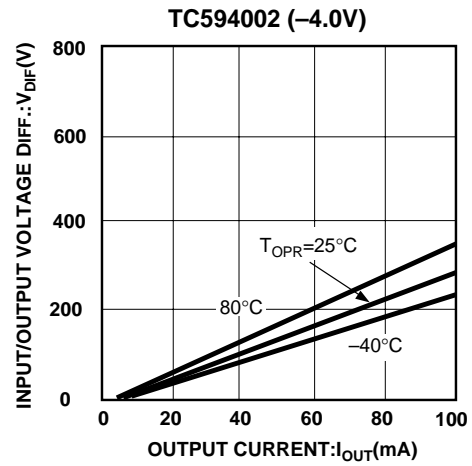
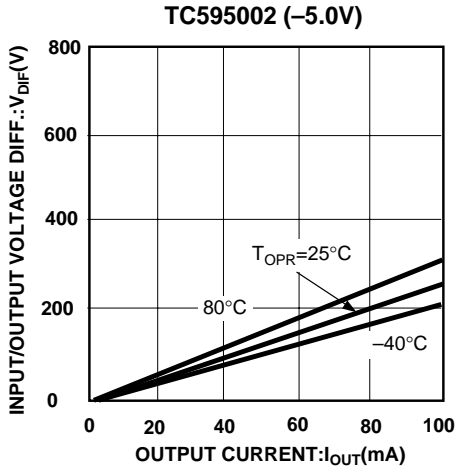

4. SUPPLY CURRENT vs. INPUT VOLTAGE

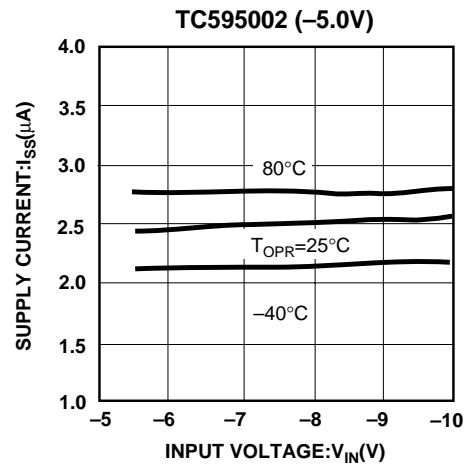
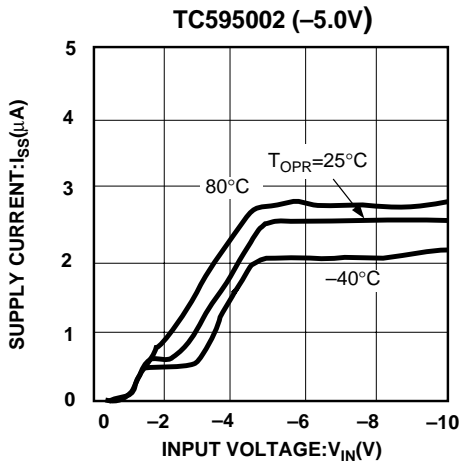

LOW DROPOUT, NEGATIVE OUTPUT VOLTAGE REGULATOR

TC59

TYPICAL CHARACTERISTICS CURVES (CONT.)

4. SUPPLY CURRENT vs. INPUT VOLTAGE (CONTINUED)

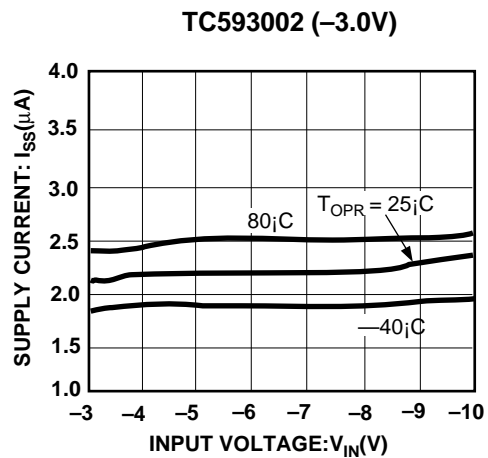
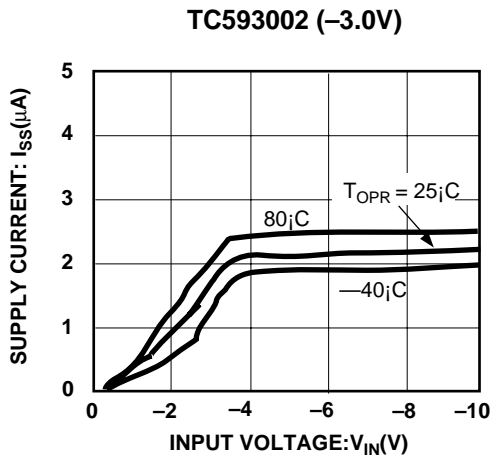
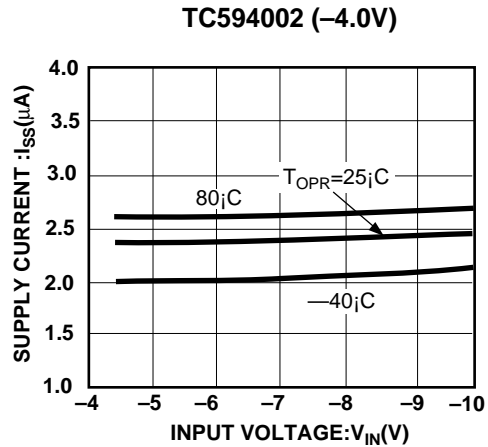
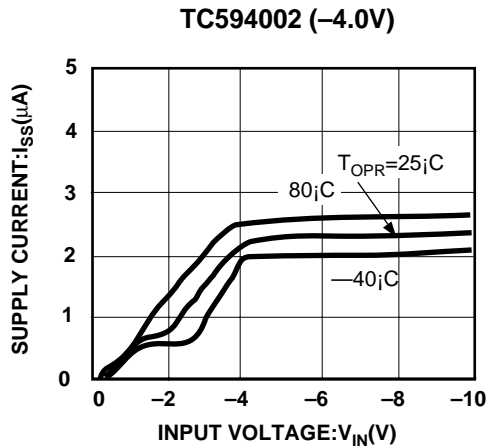

5. OUTPUT VOLTAGE vs. AMBIENT TEMPERATURE

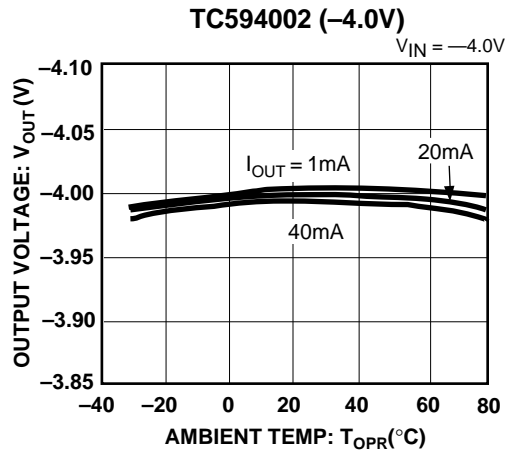
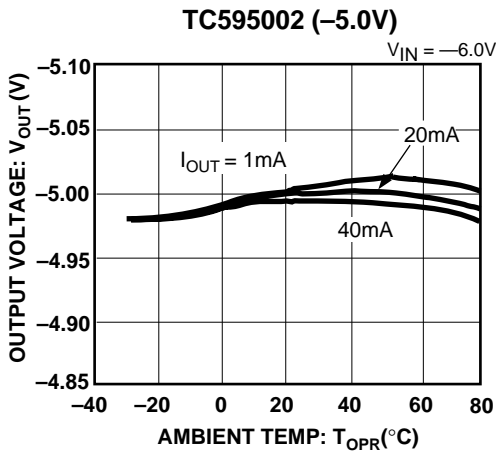

LOW DROPOUT, NEGATIVE OUTPUT VOLTAGE REGULATOR

TC59

TYPICAL CHARACTERISTICS CURVES (CONT.)

5. OUTPUT VOLTAGE vs. AMBIENT TEMPERATURE (CONTINUED)

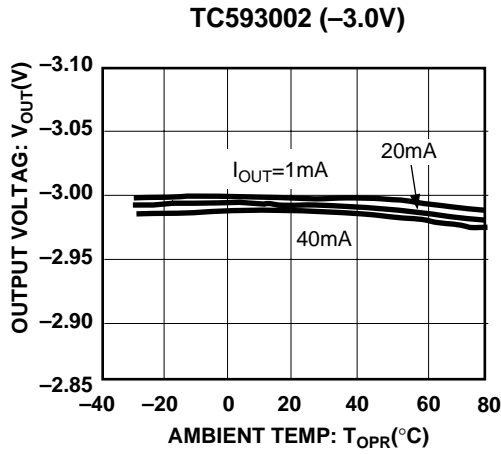

6. SUPPLY CURRENT vs. AMBIENT TEMPERATURE

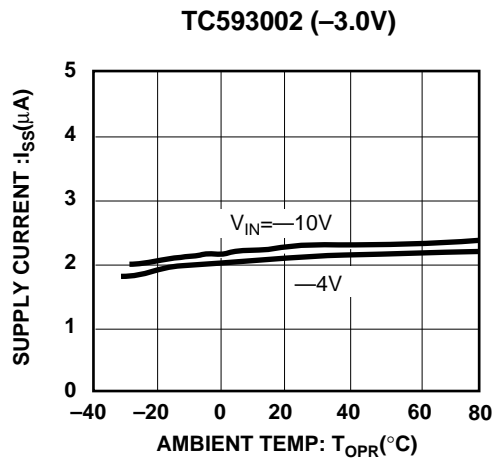
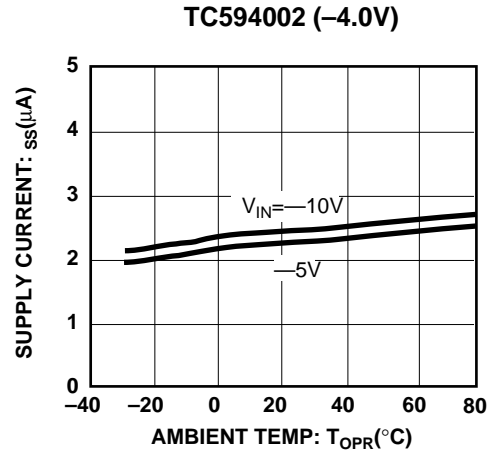
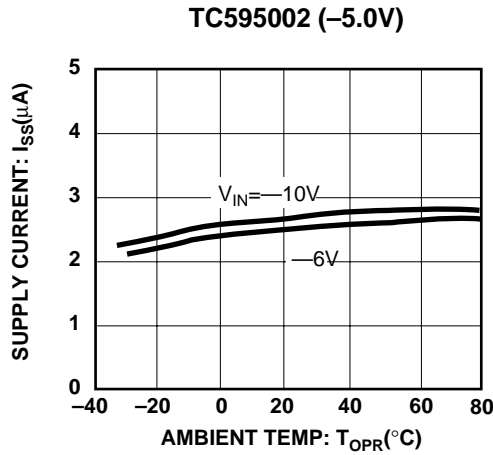

TC59

TYPICAL CHARACTERISTICS CURVES (CONT.)

7. INPUT TRANSIENT RESPONSE

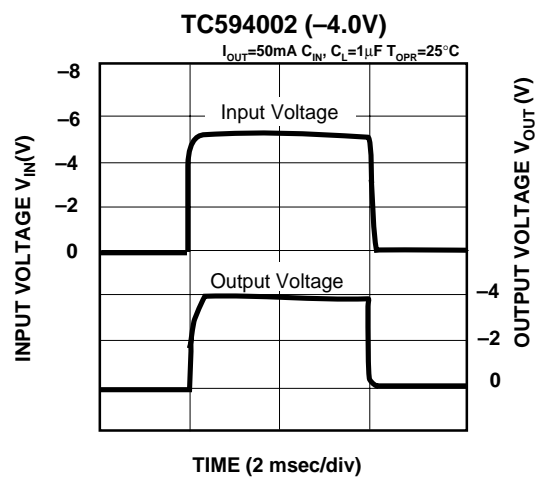
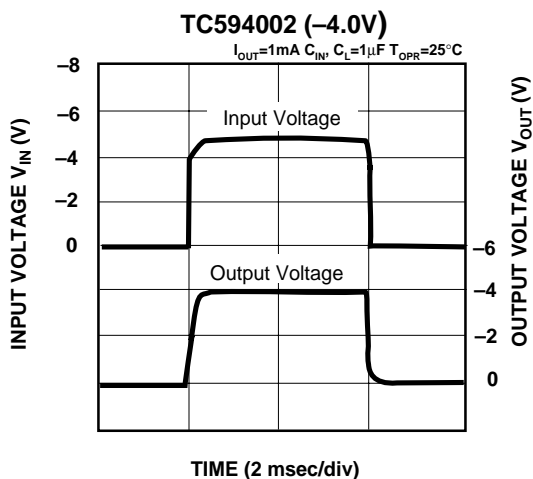
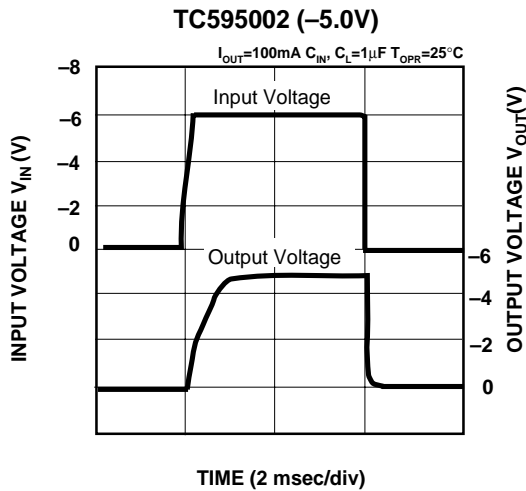
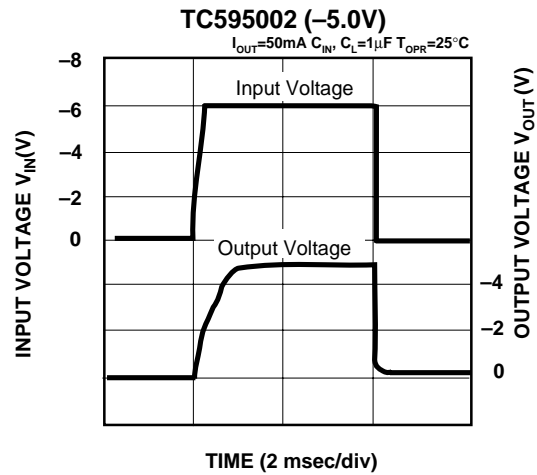
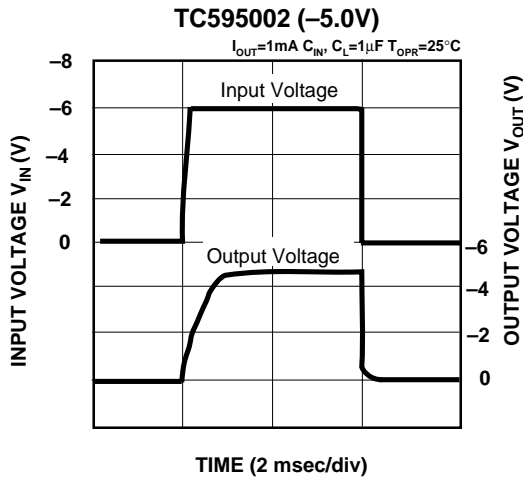

LOW DROPOUT, NEGATIVE OUTPUT VOLTAGE REGULATOR

TC59

TYPICAL CHARACTERISTICS CURVES (CONT.)

7. INPUT TRANSIENT RESPONSE (Cont.)

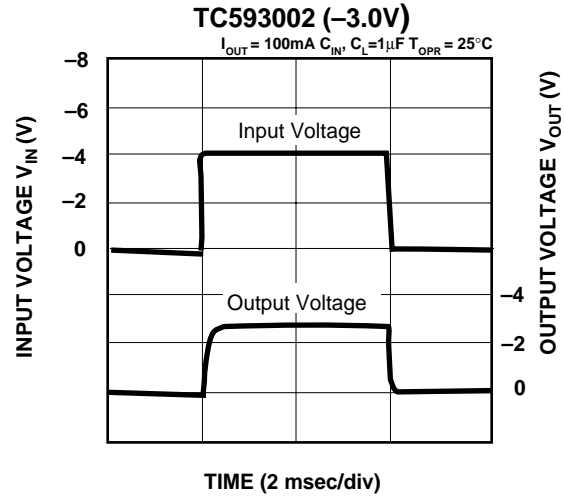
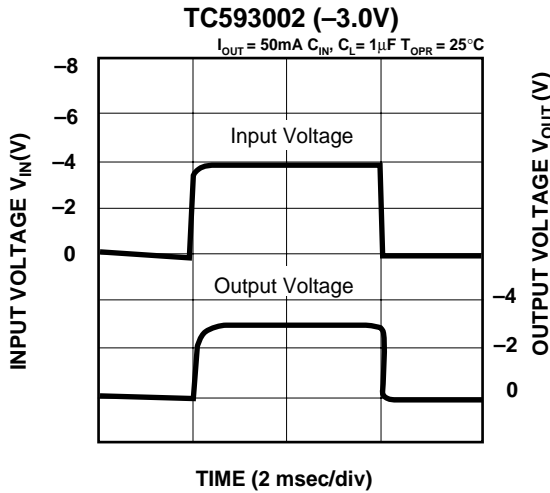
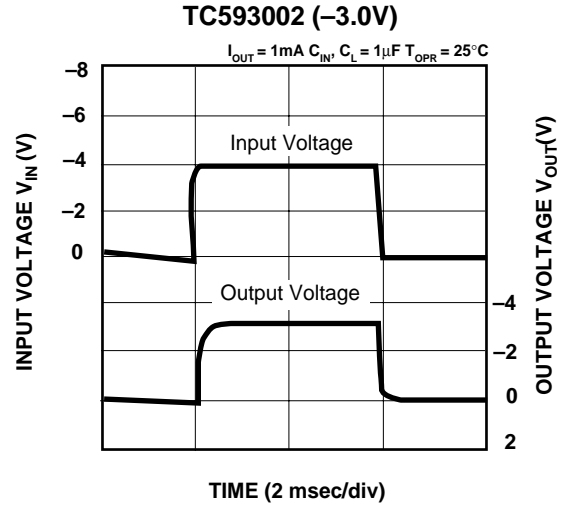
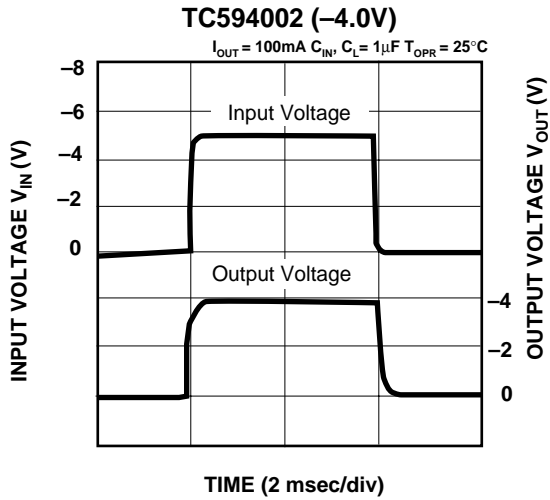

LOW DROPOUT, NEGATIVE OUTPUT VOLTAGE REGULATOR

TC59

TYPICAL CHARACTERISTICS CURVES (CONT.)

8. LOAD TRANSIENT RESPONSE

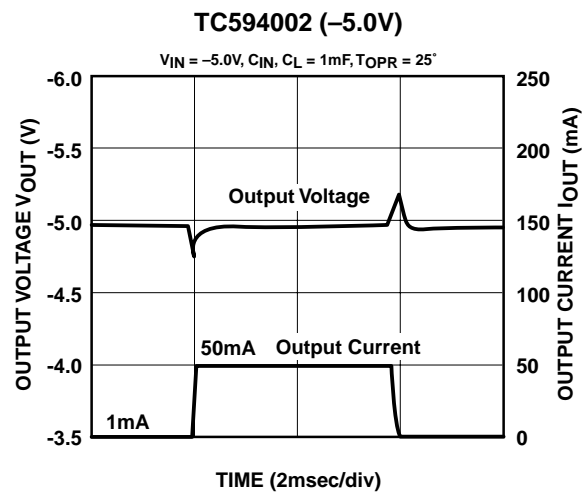
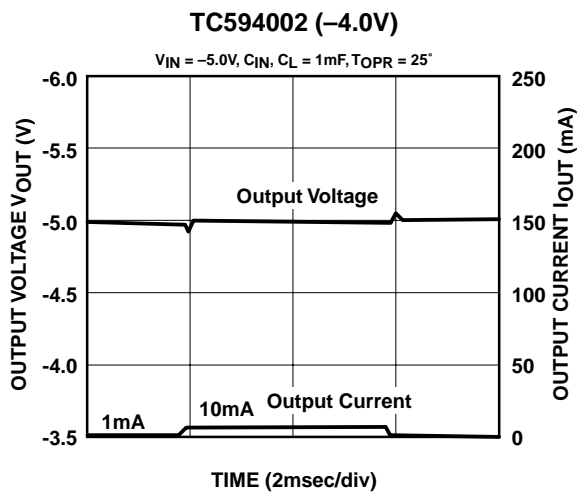
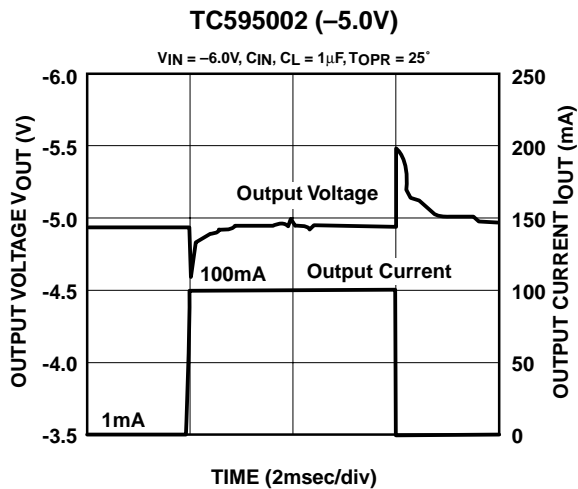
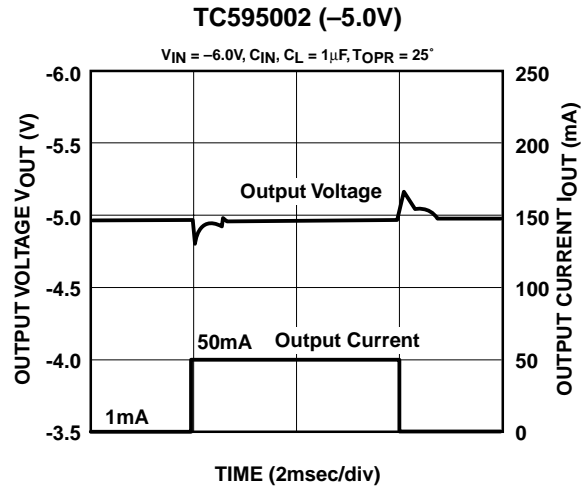
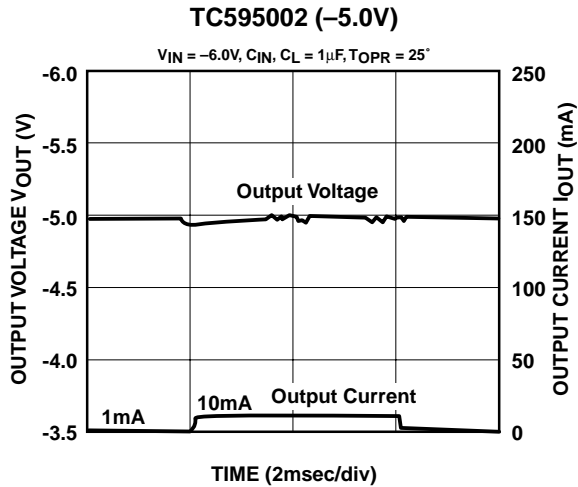

LOW DROPOUT, NEGATIVE OUTPUT VOLTAGE REGULATOR

TC59

TYPICAL CHARACTERISTICS CURVES (CONT.)

8. LOAD TRANSIENT RESPONSE (CONT.)

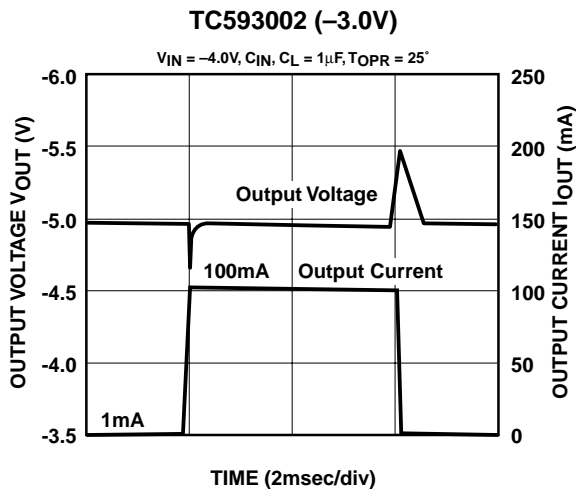
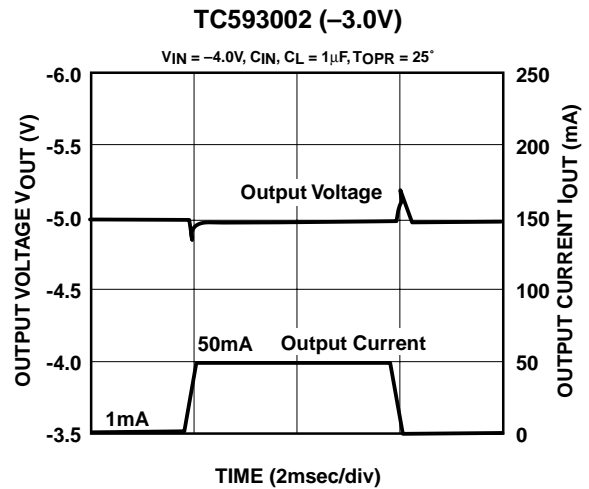
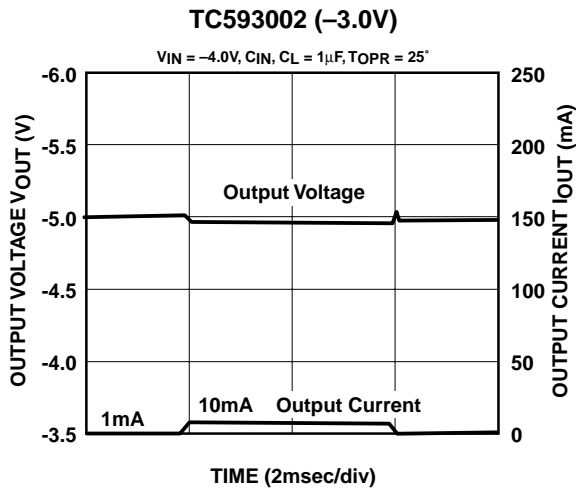
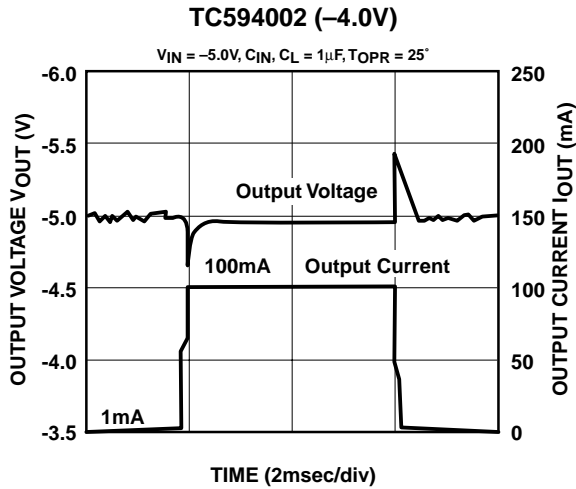

TC59

TYPICAL CHARACTERISTICS CURVES (CONT.)

9. RIPPLE REJECTION RATE

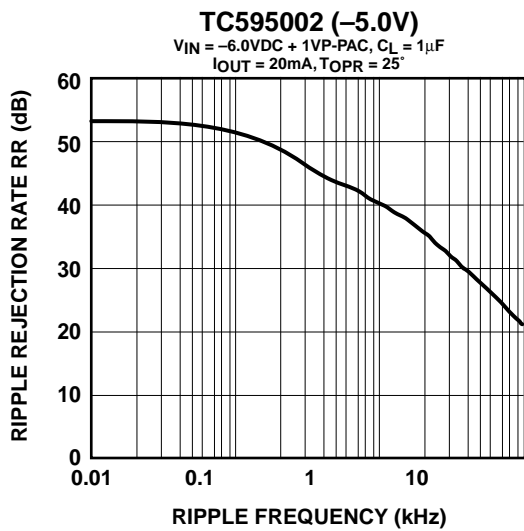
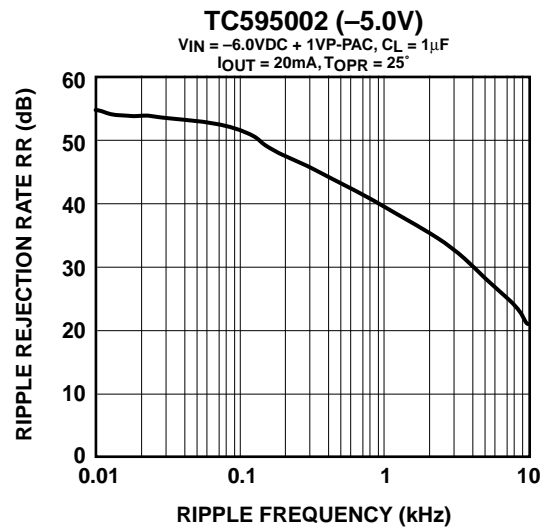
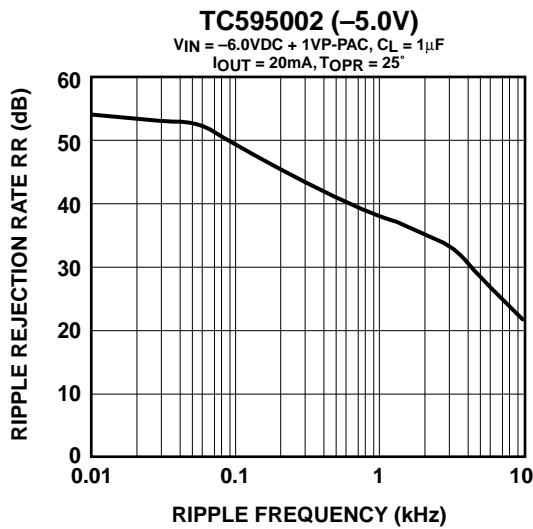

LOW DROPOUT, NEGATIVE OUTPUT VOLTAGE REGULATOR

TC59

MARKINGS

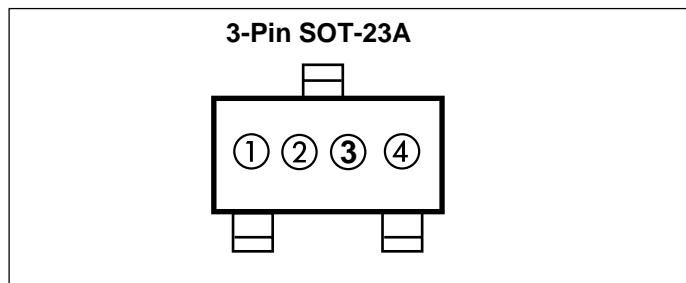

① represents 1st integer of voltage

Symbol	Voltage
0	0.
1	1.
2	2.
3	3.
4	4.
5	5.
6	6.
7	7.
8	8.
9	9.

② represents 1st decimal of voltage

Symbol	Voltage	Symbol	Voltage
A	.0	F	.5
B	.1	H	.6
C	.2	K	.7
D	.3	L	.8
E	.4	M	.9

③ represents voltage polarity

Symbol	Polarity
5	-

④ represents assembly lot code

LOW DROPOUT, NEGATIVE OUTPUT VOLTAGE REGULATOR

TC59

TAPING FORMS

Component Taping Orientation for 3-Pin SOT-23A (EIAJ SC-59) Devices

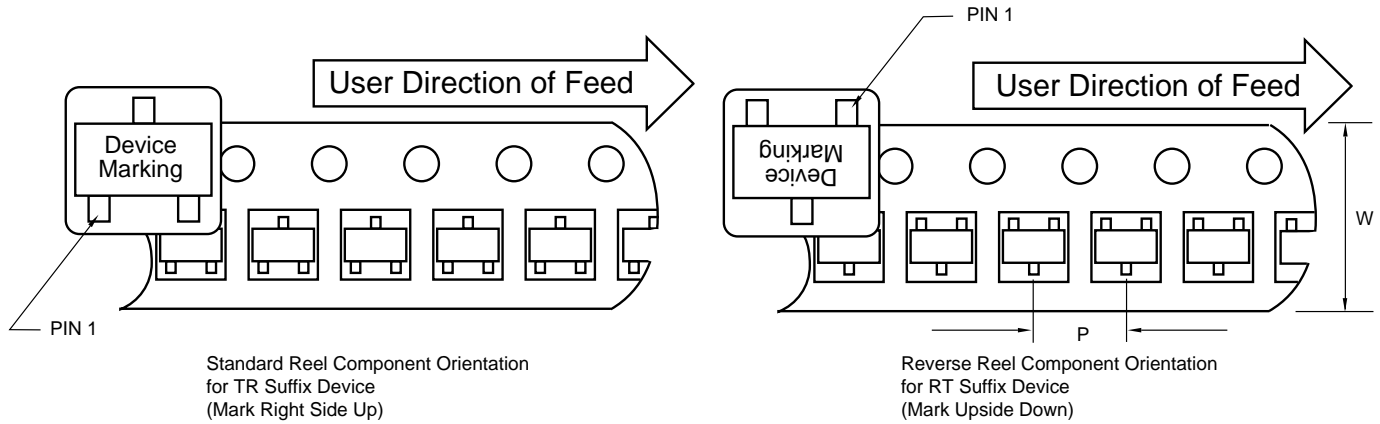

Carrier Tape, Number of Components Per Reel and Reel Size

Package	Carrier Width (W)	Pitch (P)	Part Per Full Reel	Reel Size
3-Pin SOT-23A	8 mm	4 mm	3000	7 in

PACKAGE DIMENSIONS

3-Pin SOT-23A (EIAJ SC-59)

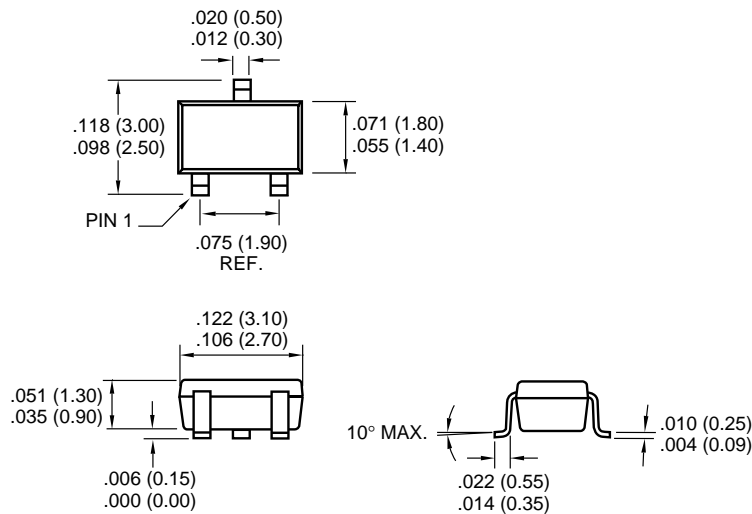

Dimensions: inches (mm)



WORLDWIDE SALES AND SERVICE

AMERICAS

Corporate Office

2355 West Chandler Blvd.
Chandler, AZ 85224-6199
Tel: 480-792-7200 Fax: 480-792-7277
Technical Support: 480-792-7627
Web Address: <http://www.microchip.com>

Rocky Mountain

2355 West Chandler Blvd.
Chandler, AZ 85224-6199
Tel: 480-792-7966 Fax: 480-792-7456

Atlanta

500 Sugar Mill Road, Suite 200B
Atlanta, GA 30350
Tel: 770-640-0034 Fax: 770-640-0307

Austin

Analog Product Sales
8303 MoPac Expressway North
Suite A-201
Austin, TX 78759
Tel: 512-345-2030 Fax: 512-345-6085

Boston

2 Lan Drive, Suite 120
Westford, MA 01886
Tel: 978-692-3848 Fax: 978-692-3821

Boston

Analog Product Sales
Unit A-8-1 Millbrook Tarry Condominium
97 Lowell Road
Concord, MA 01742
Tel: 978-371-6400 Fax: 978-371-0050

Chicago

333 Pierce Road, Suite 180
Itasca, IL 60143
Tel: 630-285-0071 Fax: 630-285-0075

Dallas

4570 Westgrove Drive, Suite 160
Addison, TX 75001
Tel: 972-818-7423 Fax: 972-818-2924

Dayton

Two Prestige Place, Suite 130
Miamisburg, OH 45342
Tel: 937-291-1654 Fax: 937-291-9175

Detroit

Tri-Atria Office Building
32255 Northwestern Highway, Suite 190
Farmington Hills, MI 48334
Tel: 248-538-2250 Fax: 248-538-2260

Los Angeles

18201 Von Karman, Suite 1090
Irvine, CA 92612
Tel: 949-263-1888 Fax: 949-263-1338

Mountain View

Analog Product Sales
1300 Terra Bella Avenue
Mountain View, CA 94043-1836
Tel: 650-968-9241 Fax: 650-967-1590

New York

150 Motor Parkway, Suite 202
Hauppauge, NY 11788
Tel: 631-273-5305 Fax: 631-273-5335

San Jose

Microchip Technology Inc.
2107 North First Street, Suite 590
San Jose, CA 95131
Tel: 408-436-7950 Fax: 408-436-7955

Toronto

6285 Northam Drive, Suite 108
Mississauga, Ontario L4V 1X5, Canada
Tel: 905-673-0699 Fax: 905-673-6509

ASIA/PACIFIC

China - Beijing

Microchip Technology Beijing Office
Unit 915
New China Hong Kong Manhattan Bldg.
No. 6 Chaoyangmen Beidajie
Beijing, 100027, No. China
Tel: 86-10-85282100 Fax: 86-10-85282104

China - Shanghai

Microchip Technology Shanghai Office
Room 701, Bldg. B
Far East International Plaza
No. 317 Xian Xia Road
Shanghai, 200051
Tel: 86-21-6275-5700 Fax: 86-21-6275-5060

Hong Kong

Microchip Asia Pacific
RM 2101, Tower 2, Metroplaza
223 Hing Fong Road
Kwai Fong, N.T., Hong Kong
Tel: 852-2401-1200 Fax: 852-2401-3431

India

Microchip Technology Inc.
India Liaison Office
Divyasree Chambers
1 Floor, Wing A (A3/A4)
No. 11, OISHaugnessey Road
Bangalore, 560 025, India
Tel: 91-80-2290061 Fax: 91-80-2290062

Japan
Microchip Technology Intl. Inc.
Benex S-1 6F
3-18-20, Shinyokohama
Kohoku-Ku, Yokohama-shi
Kanagawa, 222-0033, Japan
Tel: 81-45-471-6166 Fax: 81-45-471-6122

Korea

Microchip Technology Korea
168-1, Youngbo Bldg. 3 Floor
Samsung-Dong, Kangnam-Ku
Seoul, Korea
Tel: 82-2-554-7200 Fax: 82-2-558-5934

ASIA/PACIFIC (continued)

Singapore

Microchip Technology Singapore Pte Ltd.
200 Middle Road
#07-02 Prime Centre
Singapore, 188980
Tel: 65-334-8870 Fax: 65-334-8850

Taiwan

Microchip Technology Taiwan
11F-3, No. 207
Tung Hua North Road
Taipei, 105, Taiwan
Tel: 886-2-2717-7175 Fax: 886-2-2545-0139

EUROPE

Australia

Microchip Technology Australia Pty Ltd
Suite 22, 41 Rawson Street
Epping 2121, NSW
Australia
Tel: 61-2-9868-6733 Fax: 61-2-9868-6755

Denmark

Microchip Technology Denmark ApS
Regus Business Centre
Lautrup hoy 1-3
Ballerup DK-2750 Denmark
Tel: 45 4420 9895 Fax: 45 4420 9910

France

Arizona Microchip Technology SARL
Parc d'Activite du Moulin de Massy
43 Rue du Saule Trapu
Batiment A - ler Etage
91300 Massy, France
Tel: 33-1-69-53-63-20 Fax: 33-1-69-30-90-79

Germany

Arizona Microchip Technology GmbH
Gustav-Heinemann Ring 125
D-81739 Munich, Germany
Tel: 49-89-627-144 0 Fax: 49-89-627-144-44

Germany

Analog Product Sales
Lochamer Strasse 13
D-82152 Martinsried, Germany
Tel: 49-89-895650-0 Fax: 49-89-895650-22

Italy

Arizona Microchip Technology SRL
Centro Direzionale Colleoni
Palazzo Taurus 1 V. Le Colleoni 1
20041 Agrate Brianza
Milan, Italy
Tel: 39-039-65791-1 Fax: 39-039-6899883

United Kingdom

Arizona Microchip Technology Ltd.
505 Eskdale Road
Winnersh Triangle
Wokingham
Berkshire, England RG41 5TU
Tel: 44 118 921 5869 Fax: 44-118 921-5820

All rights reserved. © 2001 Microchip Technology Incorporated. Printed in the USA. 1/01  Printed on recycled paper.

01/09/01

Information contained in this publication regarding device applications and the like is intended through suggestion only and may be superseded by updates. It is your responsibility to ensure that your application meets with your specifications. No representation or warranty is given and no liability is assumed by Microchip Technology Incorporated with respect to the accuracy or use of such information, or infringement of patents or other intellectual property rights arising from such use or otherwise. Use of Microchip's products as critical components in life support systems is not authorized except with express written approval by Microchip. No licenses are conveyed, implicitly or otherwise, except as maybe explicitly expressed herein, under any intellectual property rights. The Microchip logo and name are registered trademarks of Microchip Technology Inc. in the U.S.A. and other countries. All rights reserved. All other trademarks mentioned herein are the property of their respective companies.