

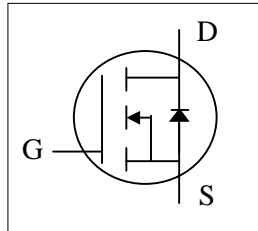

- ▼ Dynamic dv/dt Rating
- ▼ Repetitive Avalanche Rated
- ▼ Fast Switching
- ▼ Simple Drive Requirement



BV_{DSS}	600/675V
$R_{DS(ON)}$	0.75 Ω
I_D	9A

Description

AP09N70 series are specially designed as main switching devices for univers 90~265VAC off-line AC/DC converter applications.Both TO-220 and TO-262 type provide high blocking voltage to overcome voltage surge and sag in the toughest power system with the best combination of fast switching,ruggedized design and cost-effectiveness.

The TO-220 and TO-262 package is universally preferred for all commercial-industrial applications. The device is suited for switch mode power supplies ,DC-AC converters and high current high speed switching circuits.

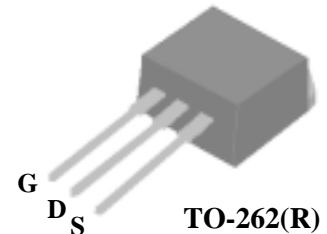
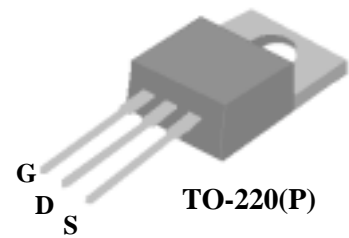

Absolute Maximum Ratings

Symbol	Parameter	Rating	Units
V_{DS}	Drain-Source Voltage - /A	600/675	V
V_{GS}	Gate-Source Voltage	± 30	V
$I_D @ T_C=25^\circ C$	Continuous Drain Current, $V_{GS} @ 10V$	9	A
$I_D @ T_C=100^\circ C$	Continuous Drain Current, $V_{GS} @ 10V$	5	A
I_{DM}	Pulsed Drain Current ¹	40	A
$P_D @ T_C=25^\circ C$	Total Power Dissipation	156	W
	Linear Derating Factor	1.25	W/ $^\circ C$
E_{AS}	Single Pulse Avalanche Energy ²	305	mJ
I_{AR}	Avalanche Current	9	A
E_{AR}	Repetitive Avalanche Energy	9	mJ
T_{STG}	Storage Temperature Range	-55 to 150	$^\circ C$
T_J	Operating Junction Temperature Range	-55 to 150	$^\circ C$

Thermal Data

Symbol	Parameter	Value	Unit
Rthj-c	Thermal Resistance Junction-case	Max. 0.8	$^\circ C/W$
Rthj-a	Thermal Resistance Junction-ambient	Max. 62	$^\circ C/W$



Electrical Characteristics @T_j=25°C(unless otherwise specified)

Symbol	Parameter	Test Conditions	Min.	Typ.	Max.	Units
BV _{DSS}	Drain-Source Breakdown Voltage	V _{GS} =0V, I _D =1mA / -	600	-	-	V
		V _{GS} =0V, I _D =1mA / A	675	-	-	V
ΔBV _{DSS} /ΔT _j	Breakdown Voltage Temperature Coefficient	Reference to 25°C, I _D =1mA	-	0.6	-	V/°C
R _{DS(ON)}	Static Drain-Source On-Resistance	V _{GS} =10V, I _D =4.5A	-	-	0.75	Ω
V _{GS(th)}	Gate Threshold Voltage	V _{DS} =V _{GS} , I _D =250uA	2	-	4	V
g _{fs}	Forward Transconductance	V _{DS} =10V, I _D =4.5A	-	4.5	-	S
I _{DSS}	Drain-Source Leakage Current (T _j =25°C)	V _{DS} =600V, V _{GS} =0V	-	-	10	uA
		V _{DS} =480V, V _{GS} =0V	-	-	100	uA
I _{GSS}	Gate-Source Leakage	V _{GS} = ± 30V	-	-	±100	nA
Q _g	Total Gate Charge ³	I _D =9A	-	44	-	nC
Q _{gs}	Gate-Source Charge	V _{DS} =480V	-	11	-	nC
Q _{gd}	Gate-Drain ("Miller") Charge	V _{GS} =10V	-	12	-	nC
t _{d(on)}	Turn-on Delay Time ³	V _{DD} =300V	-	19	-	ns
t _r	Rise Time	I _D =9A	-	21	-	ns
t _{d(off)}	Turn-off Delay Time	R _G =10Ω, V _{GS} =10V	-	56	-	ns
t _f	Fall Time	R _D =34Ω	-	24	-	ns
C _{iss}	Input Capacitance	V _{GS} =0V	-	2660	-	pF
C _{oss}	Output Capacitance	V _{DS} =25V	-	170	-	pF
C _{rss}	Reverse Transfer Capacitance	f=1.0MHz	-	10	-	pF

Source-Drain Diode

Symbol	Parameter	Test Conditions	Min.	Typ.	Max.	Units
I _S	Continuous Source Current (Body Diode)	V _D =V _G =0V , V _S =1.5V	-	-	9	A
I _{SM}	Pulsed Source Current (Body Diode) ¹		-	-	40	A
V _{SD}	Forward On Voltage ³	T _j =25°C, I _S =9A, V _{GS} =0V	-	-	1.5	V

Notes:

- 1.Pulse width limited by safe operating area.
- 2.Starting T_j=25°C , V_{DD}=50V , L=6.8mH , R_G=25Ω , I_{AS}=9A.
- 3.Pulse width ≤300us , duty cycle ≤2%.

Ordering Code

AP09N70P(/R)-X : X Denote BV_{DSS} Grade
 Blank = BV_{DSS} 600V
 A = BV_{DSS} 675V

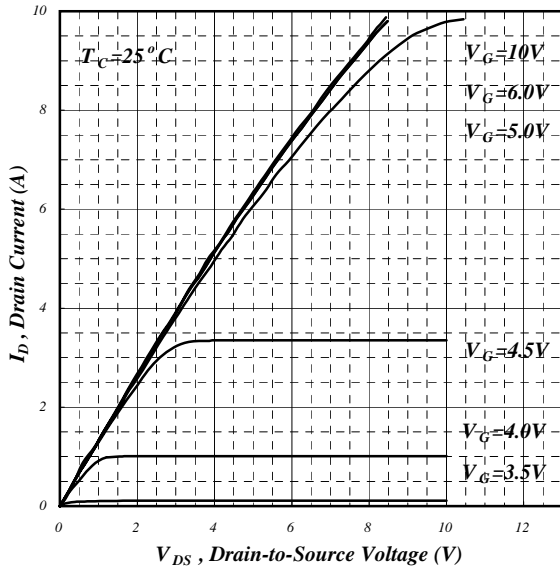

Fig 1. Typical Output Characteristics

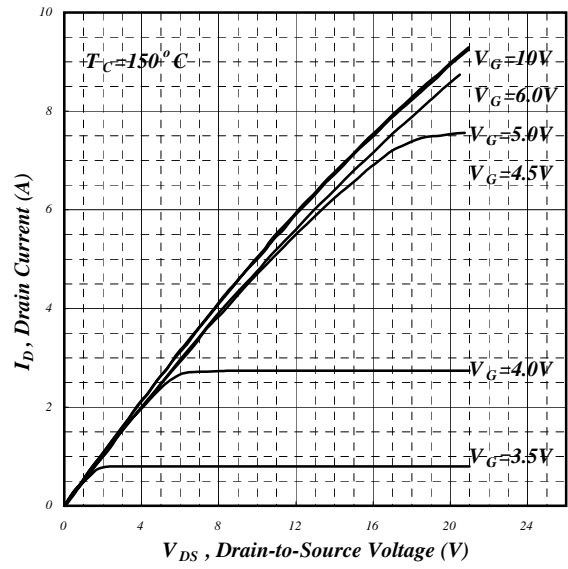

Fig 2. Typical Output Characteristics

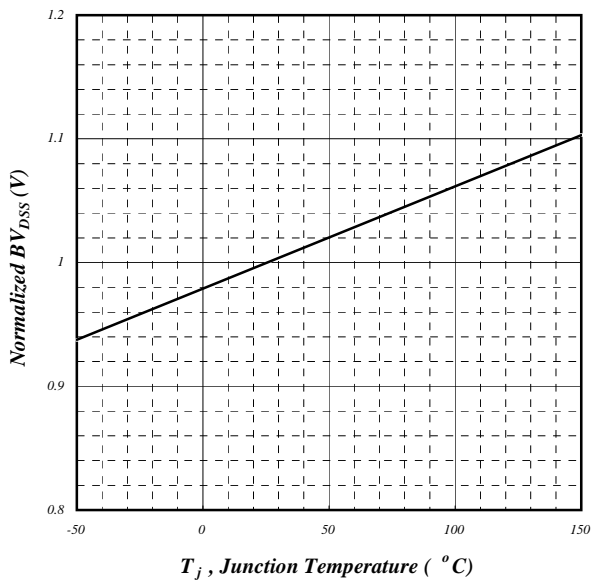

Fig 3. Normalized BV_{DSS} v.s. Junction Temperature

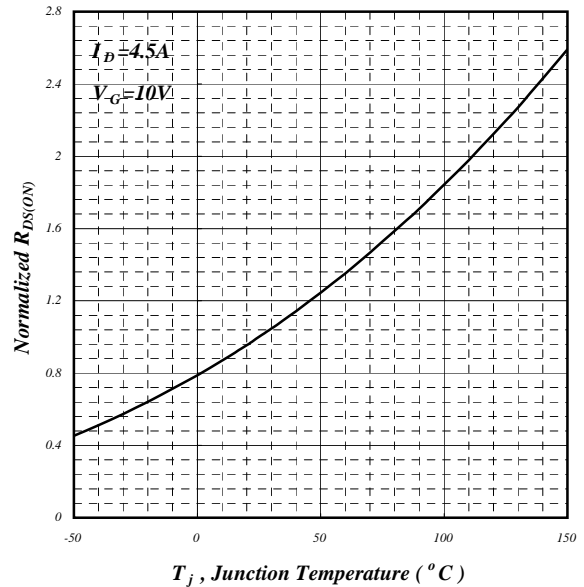

Fig 4. Normalized On-Resistance v.s. Junction Temperature

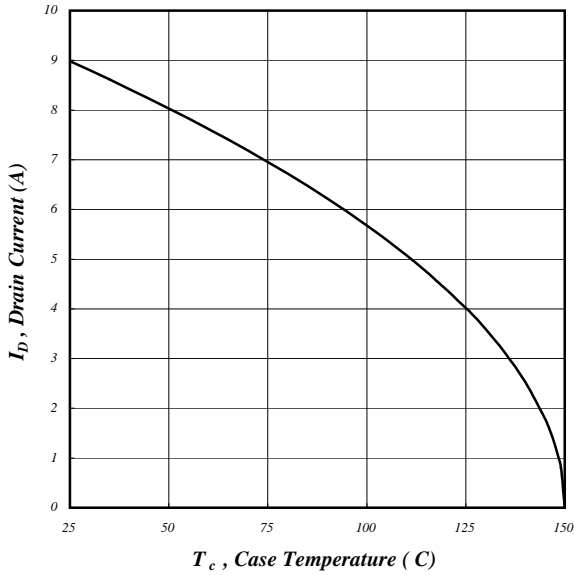

Fig 5. Maximum Drain Current v.s. Case Temperature

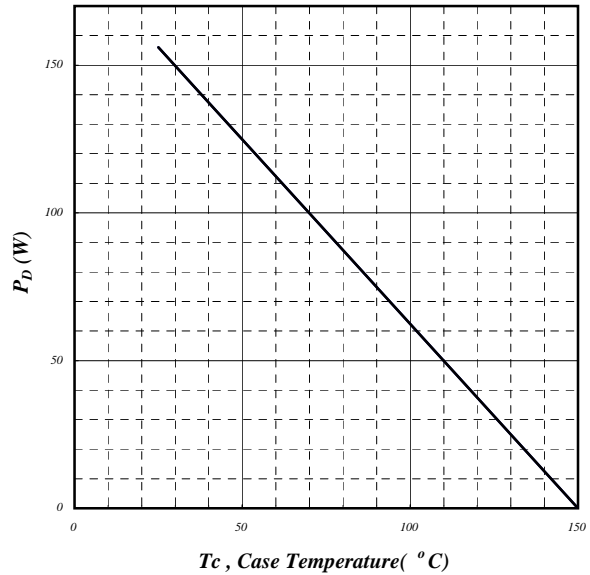

Fig 6. Typical Power Dissipation

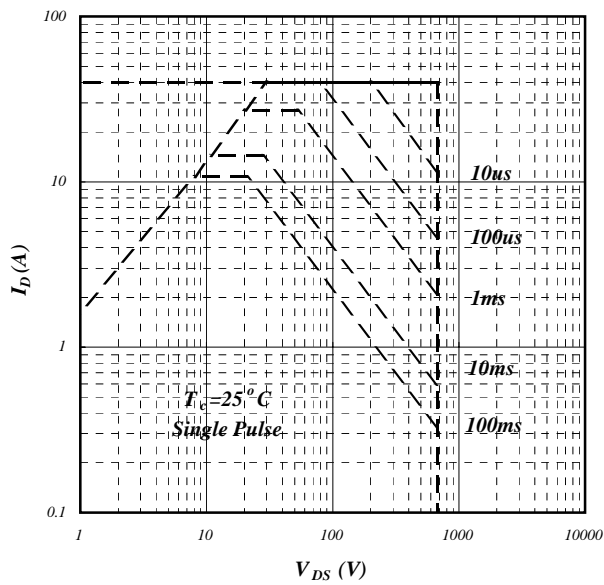

Fig 7. Maximum Safe Operating Area

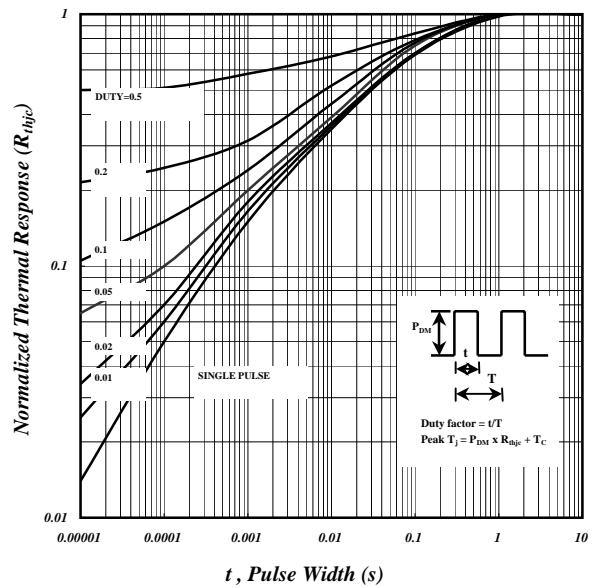

Fig 8. Effective Transient Thermal Impedance

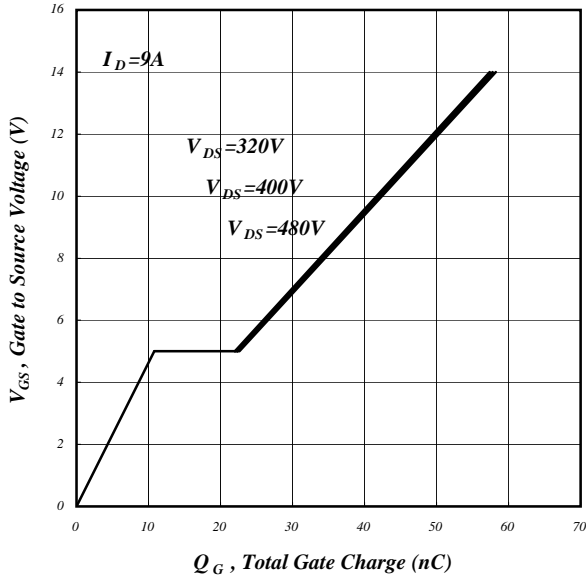

Fig 9. Gate Charge Characteristics

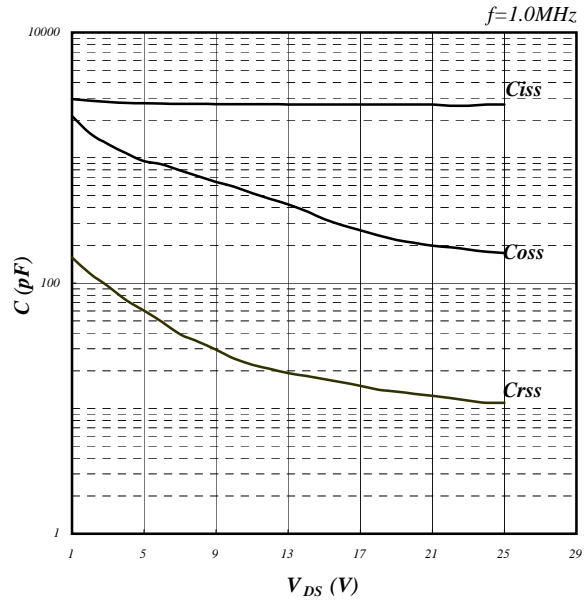

Fig 10. Typical Capacitance Characteristics

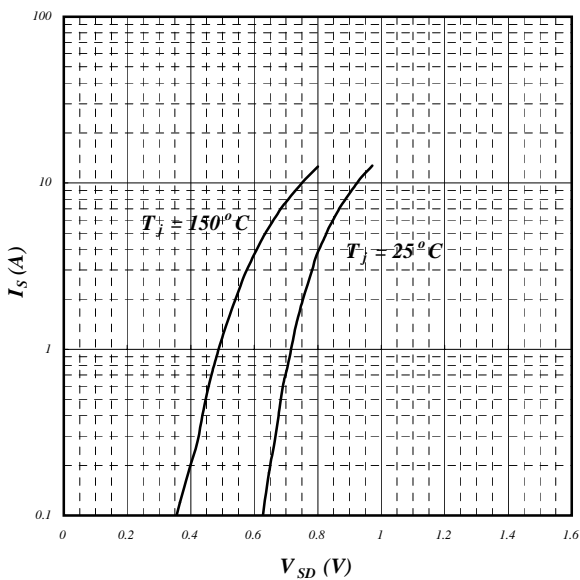

Fig 11. Forward Characteristic of Reverse Diode

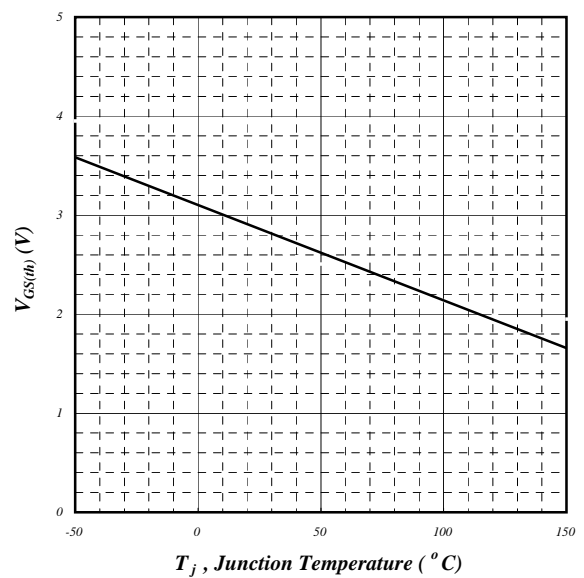

Fig 12. Gate Threshold Voltage v.s. Junction Temperature

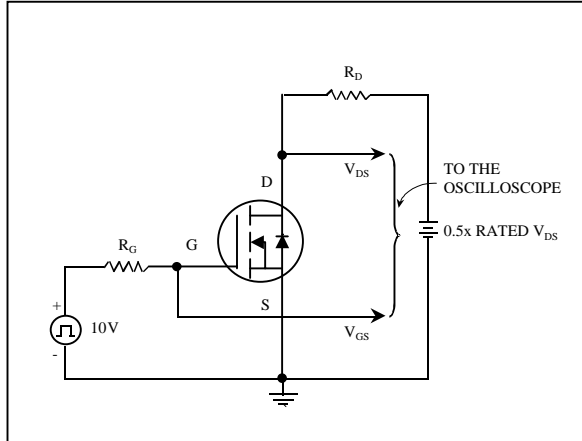

Fig 13. Switching Time Circuit

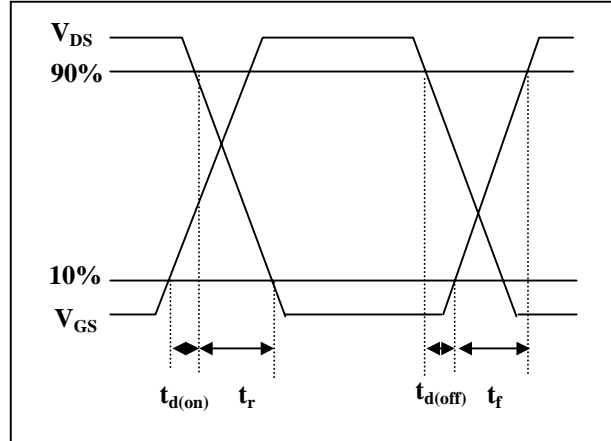

Fig 14. Switching Time Waveform

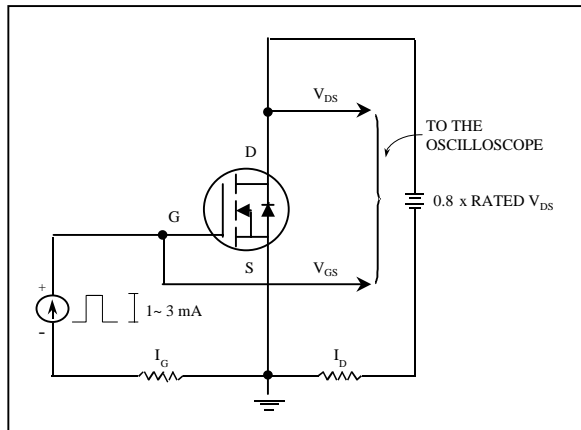

Fig 15. Gate Charge Circuit

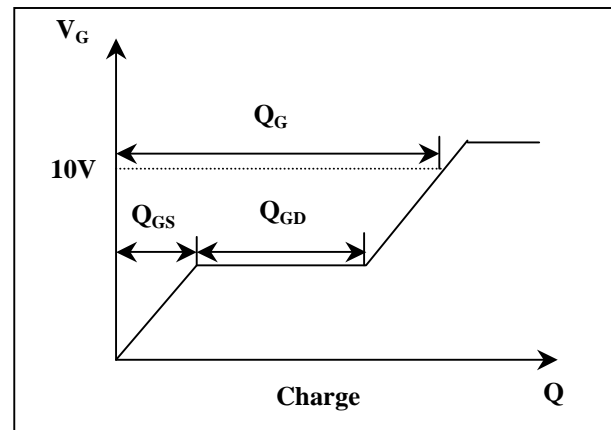

Fig 16. Gate Charge Waveform