

# 32.768 kHz FREQUENCY SMD CRYSTAL

## LOW PROFILE, HEAT RESISTANT PLASTIC PACKAGE



ABS25

Pb in High Temperature Solder  
(exempt per RoHS 2002/95/EC Annex (7))

**RoHS**  
Compliant

### FEATURES:

- Low frequency in small size SMD
- 2.5mm height ideal for high density circuit boards
- Excellent environmental & heat resistance plastic package with reflow capability
- Extended temperature -40°C to +85°C for industrial applications

### APPLICATIONS:

- Wide range in communication & measuring equipment
- Commercial & Industrial applications
- Automotive electronics applications \*
- Wireless communications
- PDA and Palm Pilots

### STANDARD SPECIFICATIONS:

PARAMETERS	
ABRACON P/N	ABS25
Standard Frequency	<b>32.768 kHz</b>
Additional Frequencies Available*	32.00kHz, 36.00kHz, 38.40kHz, 40.00kHz, 60.00kHz, 75.00kHz, 76.80kHz, 96.00kHz, 100.00kHz
Frequency Range	30kHz to 100kHz
Operating Temperature	-40°C to + 85°C
Turn-over Temperature	+25°C to ±5°C
Storage Temperature	-55°C to +125°C
Frequency Tolerance	±20 ppm max. (for 32.768kHz) ±30 ppm max. for other frequencies (see options)
Capacitance Ratio	450 typ. (32.768kHz) 425 to 800 typ. (others)
Frequency Coefficient ( $\beta$ )	- 0.034±0.006 ppm/T <sup>2</sup>
Equivalent Series Resistance	50 kohms max.
Load Capacitance CL	12.5 pF (see option)
Shunt Capacitance C0	1.35 pF typ. (32.768kHz) 0.8 pF to 1.7 pF typ. (others)
Drive Level	1.0 $\mu$ W max.
Aging @ 25°C ± 3°C first year	± 3 ppm max. (32.768kHz) ± 5 ppm max. (others)
Insulation Resistance	500 M $\Omega$ with 100 Vdc ±15V

### TUNING FORK CRYSTAL TEMPERATURE CURVE

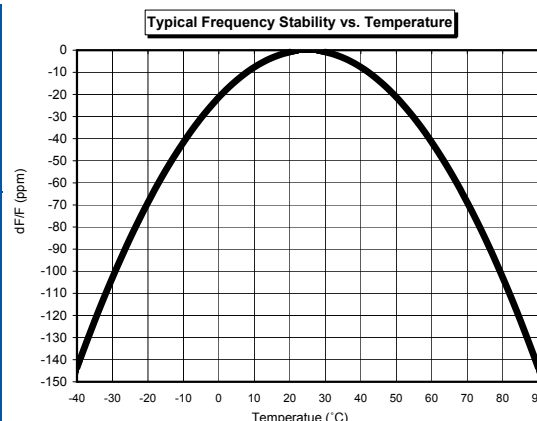

\* For additional frequencies please contact Abracon.

### OPTIONS AND PART IDENTIFICATION:

(Left blank if standard)

ABS25- Frequency-  -  -

CL Option
Please specify load cap. in pF (ex. 6pF)

Freq. Tolerance	
1	± 10 ppm
5	± 15 ppm
2	± 20 ppm
3	± 25 ppm
4	± 30 ppm

Packaging	
Blank	Bulk
T	Tape and Reel

ABRACON IS  
ISO 9001 / QS 9000  
CERTIFIED



**ABRACON**  
CORPORATION

Visit [www.abracon.com](http://www.abracon.com) for Terms & Conditions of Sale **Revised: 08.27.09**  
30332 Esperanza, Rancho Santa Margarita, California 92688  
tel 949-546-8000 | fax 949-546-8001 | [www.abracon.com](http://www.abracon.com)

# 32.768 kHz FREQUENCY SMD CRYSTAL

## LOW PROFILE, HEAT RESISTANT PLASTIC PACKAGE



ABS25

Pb in High Temperature Solder  
(exempt per RoHS 2002/95/EC Annex (7))

**RoHS**  
Compliant

### OUTLINE DRAWING:

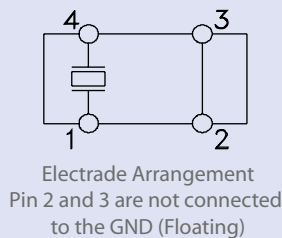
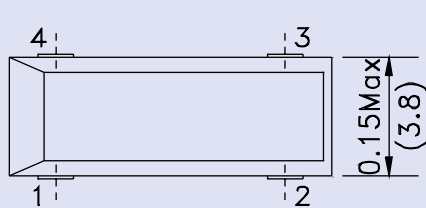

### Recommended Land Pattern

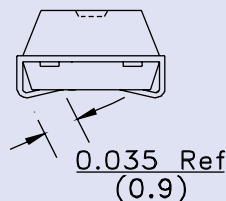
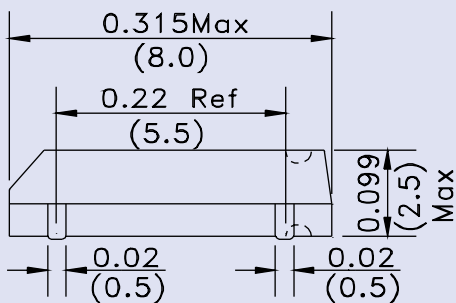
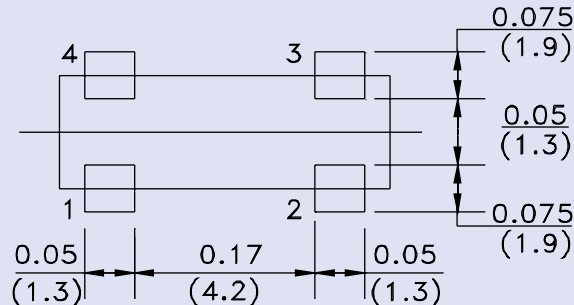

Dimensions: (inches) mm

### TAPE & REEL: T = Tape and reel 3,000pcs/reel

### REFLOW PROFILE

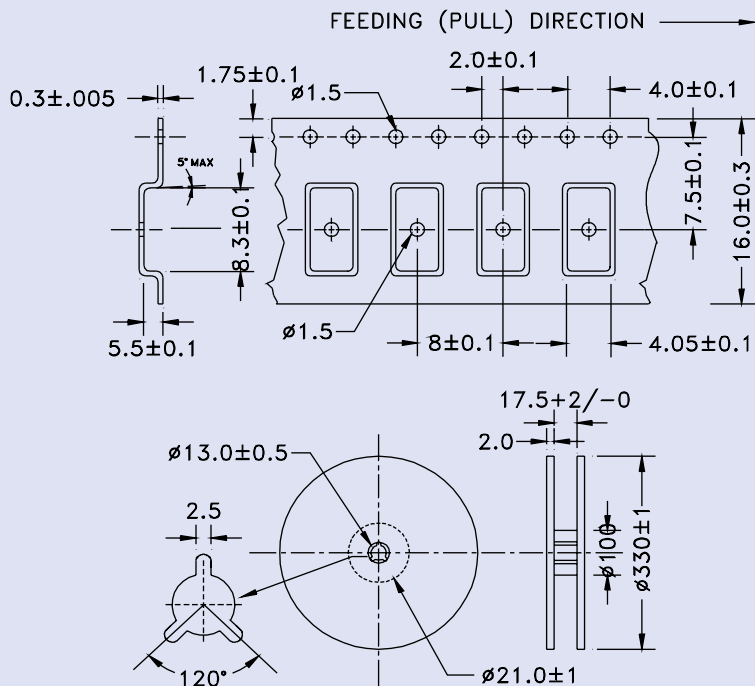

Dimensions: mm

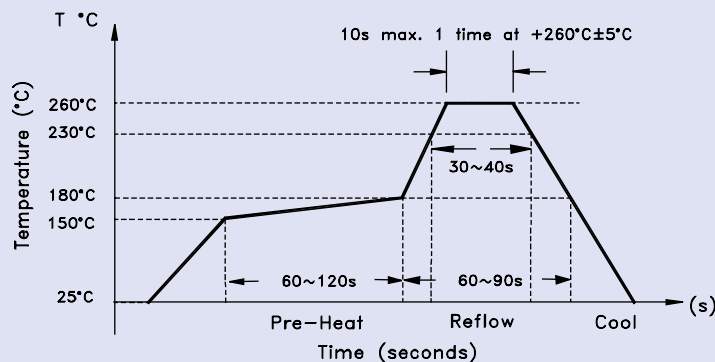

\* **NOTE:** Abracon manufactured products are intended for general commercial and industrial use. For applications requiring high reliability and/or presenting extreme operating environment, written consent & authorization from Abracon is required.

ABRACON IS  
ISO 9001 / QS 9000  
CERTIFIED



Visit [www.abracon.com](http://www.abracon.com) for Terms & Conditions of Sale **Revised: 08.27.09**  
30332 Esperanza, Rancho Santa Margarita, California 92688  
tel 949-546-8000 | fax 949-546-8001 | [www.abracon.com](http://www.abracon.com)