

HCMOS Compatible, High CMR, 10 MBd Optocouplers

Technical Data

HCPL-261A HCPL-061A
HCPL-263A HCPL-063A
HCPL-261N HCPL-061N
HCPL-263N HCPL-063N

Features

- HCMOS/LSTTL/TTL Performance Compatible
- 1000 V/μs Minimum Common Mode Rejection (CMR) at $V_{CM} = 50$ V (HCPL-261A Family) and 15 kV/μs Minimum CMR at $V_{CM} = 1000$ V (HCPL-261N Family)
- High Speed: 10 MBd Typical
- AC and DC Performance Specified over Industrial Temperature Range -40°C to +85°C
- Available in 8 Pin DIP, SOIC-8 Packages
- Safety Approval
UL Recognized per UL1577
2500 V rms for 1 minute and
5000 V rms for 1 minute
(Option 020)
CSA Approved
VDE 0884 Approved with
 $V_{IORM} = 630$ V peak for
HCPL-261A/261N
Option 060

Applications

- Low Input Current (3.0 mA) HCMOS Compatible Version of 6N137 Optocoupler
- Isolated Line Receiver
- Simplex/Multiplex Data Transmission

- Computer-Peripheral Interface
- Digital Isolation for A/D, D/A Conversion
- Switching Power Supplies
- Instrumentation Input/Output Isolation
- Ground Loop Elimination
- Pulse Transformer Replacement

Description

The HCPL-261A family of optically coupled gates shown on this data sheet provide all the benefits of the industry standard 6N137 family with the added benefit of HCMOS

compatible input current. This allows direct interface to all common circuit topologies without additional LED buffer or drive components. The AlGaAs LED used allows lower drive currents and reduces degradation by using the latest LED technology. On the single channel parts, an enable output allows the detector to be strobed. The output of the detector IC is an open collector schottky-clamped transistor. The internal shield provides a minimum common mode transient immunity of 1000 V/μs for the HCPL-261A family and 15000 V/μs for the HCPL-261N family.

Functional Diagram

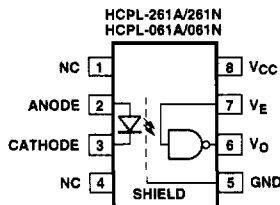

TRUTH TABLE
(POSITIVE LOGIC)

LED	ENABLE	OUTPUT
ON	H	L
OFF	H	H
ON	L	H
OFF	L	H
ON	NC	L
OFF	NC	H

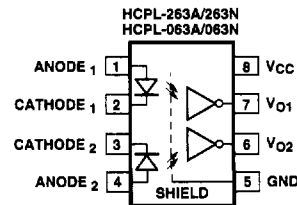

TRUTH TABLE
(POSITIVE LOGIC)

LED	OUTPUT
ON	L
OFF	H

The connection of a 0.1 μF bypass capacitor between pins 5 and 8 is required.

CAUTION: It is advised that normal static precautions be taken in handling and assembly of this component to prevent damage and/or degradation which may be induced by ESD.

Selection Guide

Minimum CMR	dV/dt (V/ μ s)	V_{CM} (V)	Input On-Current (mA)	Output Enable	8-Pin DIP (300 Mil)		Small-Outline SO-8		Widebody (400 Mil)	Hermetic
					Single Channel Package	Dual Channel Package	Single Channel Package	Dual Channel Package	Single Channel Package	Single and Dual Channel Packages
NA	NA	NA	5	YES	6N137 ^[1]		HCPL-0600 ^[1]		HCNW137 ^[1]	
				NO		HCPL-2630 ^[1]		HCPL-0630 ^[1]		
5,000	50	50	5	YES	HCPL-2601 ^[1]		HCPL-0601 ^[1]		HCNW2601 ^[1]	
				NO		HCPL-2631 ^[1]		HCPL-0631 ^[1]		
10,000	1,000	1,000	5	YES	HCPL-2611 ^[1]		HCPL-0611 ^[1]		HCNW2611 ^[1]	
				NO		HCPL-4661 ^[1]		HCPL-0661 ^[1]		
1,000	50	50	3	YES	HCPL-2602 ^[1]					
3,500	300	300		YES	HCPL-2612 ^[1]					
1,000	50	50	3	YES	HCPL-261A		HCPL-061A			
				NO		HCPL-263A		HCPL-063A		
1,000 ^[2]	1,000	1,000	3	YES	HCPL-261N		HCPL-061N			
				NO		HCPL-263N		HCPL-063N		
1,000	50	50	12.5	[3]						HCPL-193X ^[1] HCPL-56XX ^[1] HCPL-66XX ^[1]

Notes:

1. Technical data are on separate HP publications.
2. 15 kV/ μ s with $V_{CM} = 1$ kV can be achieved using HP application circuit.
3. Enable is available for single channel products only, except for HCPL-193X devices.

Ordering Information

Specify Part Number followed by Option Number (if desired).

Example:

HCPL-261A#XXX

- 020 = 5000 V rms/1 minute UL Rating Option*
- 060 = VDE 0884 $V_{IORM} = 630$ Vpeak Option**
- 300 = Gull Wing Surface Mount Option***
- 500 = Tape and Reel Packaging Option

Option data sheets available. Contact your Hewlett-Packard sales representative or authorized distributor for information.

*For HCPL-261A/261N/263A/263N (8-pin DIP products) only.

**For HCPL-261A/261N only. Combination of Option 020 and Option 060 is not available.

***Gull wing surface mount option applies to through hole parts only.

Schematic

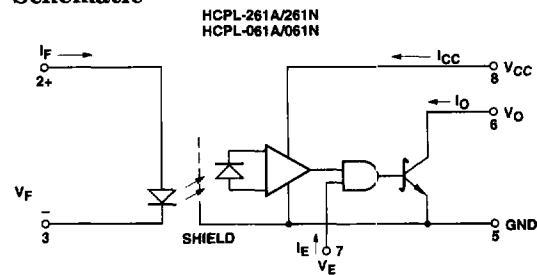

USE OF A 0.1 μ F BYPASS CAPACITOR CONNECTED BETWEEN PINS 5 AND 8 IS RECOMMENDED (SEE NOTE 16).

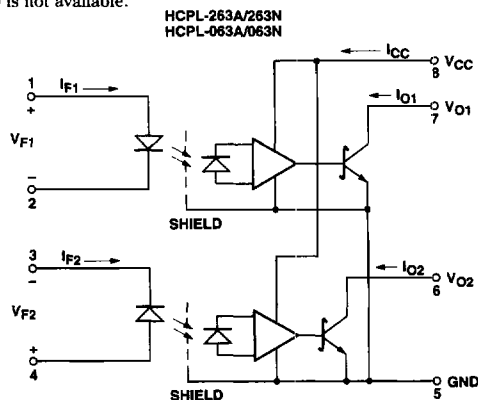

HCPL-261A/261N/263A/263N Outline Drawing

Pin Location (for reference only)

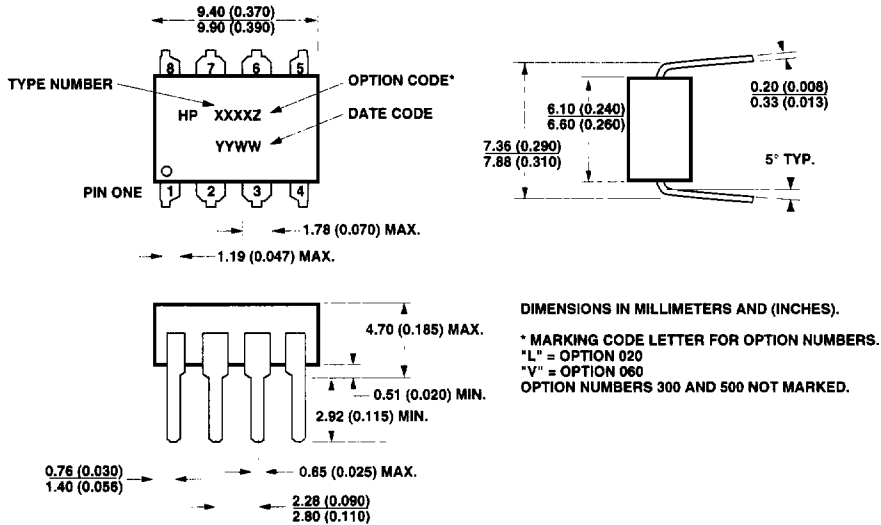

Figure 1. 8-Pin Dual In-Line Package Device Outline Drawing.

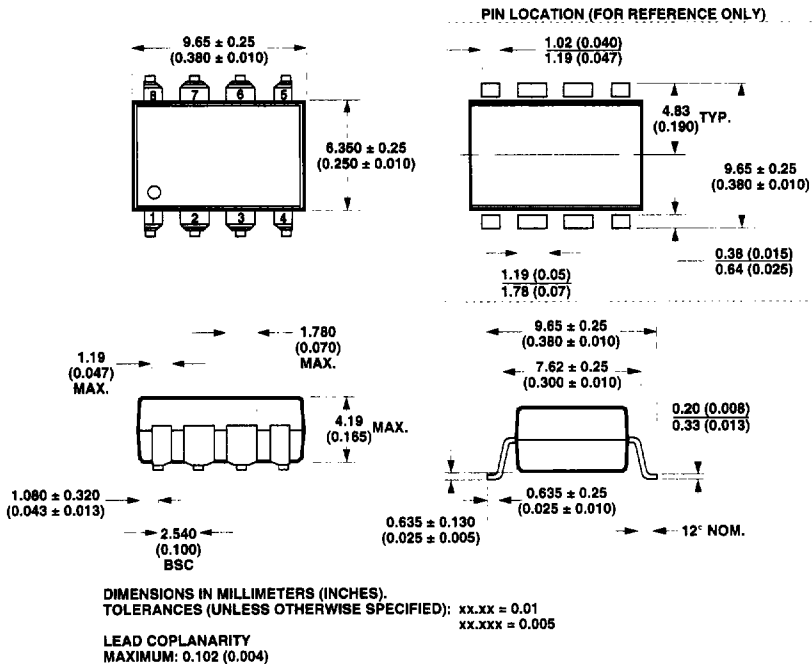

Figure 2. Gull Wing Surface Mount Option #300.

HCPL-061A/061N/063A/063N Outline Drawing

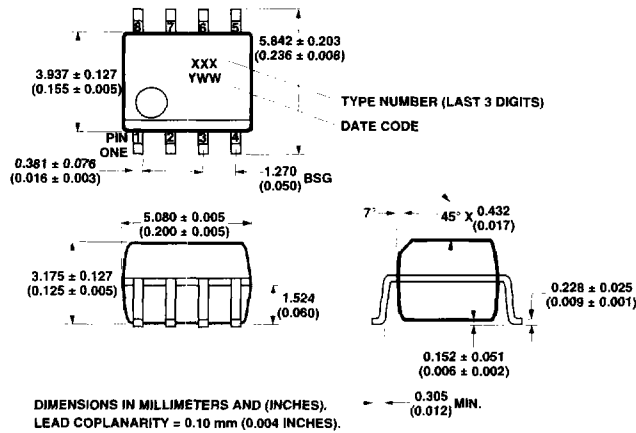
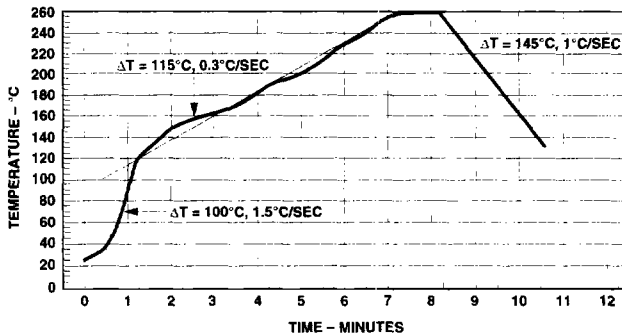

Figure 3. 8-Pin Small Outline Package Device Drawing.

Solder Reflow Temperature Profile (HCPL-06XX and Gull Wing Surface Mount Option 300 Parts)



Note: Use of Nonchlorine Activated Fluxes is Recommended.

Regulatory Information

The HCPL-261A and HCPL-261N families have been approved by the following organizations:

UL

Recognized under UL 1577, Component Recognition Program, File E55361.

CSA

Approved under CSA Component Acceptance Notice #5, File CA 88324.

VDE

Approved according to VDE 0884/06.92. (HCPL-261A/261N Option 060 only)

Insulation and Safety Related Specifications

Parameter	Symbol	8-Pin DIP (300 Mil) Value	SO-8 Value	Units	Conditions
Minimum External Air Gap (External Clearance)	L(101)	7.1	4.9	mm	Measured from input terminals to output terminals, shortest distance through air.
Minimum External Tracking (External Creepage)	L(102)	7.4	4.8	mm	Measured from input terminals to output terminals, shortest distance path along body.
Minimum Internal Plastic Gap (Internal Clearance)		0.08	0.08	mm	Through insulation distance, conductor to conductor, usually the direct distance between the photoemitter and photodetector inside the optocoupler cavity.
Tracking Resistance (Comparative Tracking Index)	CTI	200	200	Volts	DIN IEC 112/ VDE 0303 Part 1
Isolation Group		IIIa	IIIa		Material Group (DIN VDE 0110, 1/89, Table 1)

Option 300 – surface mount classification is Class A in accordance with CECC 00802.

VDE 0884 Insulation Related Characteristics (HCPL-261A/261N Option 060 ONLY)

Description	Symbol	Characteristic	Units
Installation classification per DIN VDE 0110/1.89, Table 1 for rated mains voltage ≤ 300 V rms for rated mains voltage ≤ 450 V rms		I-IV	
		I-III	
Climatic Classification		55/85/21	
Pollution Degree (DIN VDE 0110/1.89)		2	
Maximum Working Insulation Voltage	V_{IORM}	630	V_{peak}
Input to Output Test Voltage, Method b* $V_{IORM} \times 1.875 = V_{PR}$, 100% Production Test with $t_m = 1$ sec, Partial Discharge < 5 pC	V_{PR}	1181	V_{peak}
Input to Output Test Voltage, Method a* $V_{IORM} \times 1.5 = V_{PR}$, Type and sample test, $t_m = 60$ sec, Partial Discharge < 5 pC	V_{PR}	945	V_{peak}
Highest Allowable Overvoltage* (Transient Overvoltage, $t_{ini} = 10$ sec)	V_{IOTM}	6000	V_{peak}
Safety Limiting Values (Maximum values allowed in the event of a failure, also see Figure 18, Thermal Derating curve.) Case Temperature Input Current Output Power	T_S $I_{S,INPUT}$ $P_{S,OUTPUT}$	175 230 600	$^{\circ}C$ mA mW
Insulation Resistance at T_S , $V_{IO} = 500$ V	R_S	$\geq 10^9$	Ω

*Refer to the front of the optocoupler section of the current catalog, under Product Safety Regulations section (VDE 0884), for a detailed description.

Note: Isolation characteristics are guaranteed only within the safety maximum ratings which must be ensured by protective circuits in application.

Absolute Maximum Ratings

Parameter	Symbol	Min.	Max.	Units	Note
Storage Temperature	T_S	-55	125	°C	
Operating Temperature	T_A	-40	+85	°C	
Average Input Current	$I_{F(AVG)}$		10	mA	1
Reverse Input Voltage	V_R		3	Volts	
Supply Voltage	V_{CC}	-0.5	7	Volts	2
Enable Input Voltage	V_E	-0.5	5.5	Volts	
Output Collector Current (Each Channel)	I_O		50	mA	
Output Power Dissipation (Each Channel)	P_O		60	mW	3
Output Voltage (Each channel)	V_O	-0.5	7	Volts	
Lead Solder Temperature (Through Hole Parts Only)	260°C for 10 s, 1.6 mm Below Seating Plane				
Solder Reflow Temperature Profile (Surface Mount Parts Only)	See Package Outline Drawings section				

Recommended Operating Conditions

Parameter	Symbol	Min.	Max.	Units
Input Voltage, Low Level	V_{FL}	-3	0.8	V
Input Current, High Level	I_{FH}	3.0	10	mA
Power Supply Voltage	V_{CC}	4.5	5.5	Volts
High Level Enable Voltage	V_{EH}	2.0	V_{CC}	Volts
Low Level Enable Voltage	V_{EL}	0	0.8	Volts
Fan Out (at $R_L = 1\text{ k}\Omega$)	N		5	TTL Loads
Output Pull-up Resistor	R_L	330	4k	Ω
Operating Temperature	T_A	-40	85	°C

Electrical Specifications

Over recommended operating temperature ($T_A = -40^{\circ}\text{C}$ to $+85^{\circ}\text{C}$) unless otherwise specified.

Parameter	Symbol	Min.	Typ.*	Max.	Units	Test Conditions	Fig.	Note
High Level Output Current	I_{OH}		3.1	100	μA	$V_{CC} = 5.5\text{ V}$, $V_O = 5.5\text{ V}$, $V_F = 0.8\text{ V}$, $V_E = 2.0\text{ V}$	4	18
Low Level Output Voltage	V_{OL}		0.4	0.6	V	$V_{CC} = 5.5\text{ V}$, $I_{OL} = 13\text{ mA}$ (sinking), $I_F = 3.0\text{ mA}$, $V_E = 2.0\text{ V}$	5, 8	4, 18
High Level Supply Current	I_{CCH}		7	10	mA	$V_E = 0.5\text{ V}^{**}$	$V_{CC} = 5.5\text{ V}$ $I_F = 0\text{ mA}$	4
			9	15		Dual Channel Products***		
Low Level Supply Current	I_{CCL}		8	13	mA	$V_E = 0.5\text{ V}^{**}$	$V_{CC} = 5.5\text{ V}$ $I_F = 3.0\text{ mA}$	
			12	21		Dual Channel Products***		
High Level Enable Current**	I_{EH}		-0.6	-1.6	mA	$V_{CC} = 5.5\text{ V}$, $V_E = 2.0\text{ V}$		
Low Level Enable Current**	I_{EL}		-0.9	-1.6	mA	$V_{CC} = 5.5\text{ V}$, $V_E = 0.5\text{ V}$		
Input Forward Voltage	V_F	1.0	1.3	1.6	V	$I_F = 4\text{ mA}$	6	4
Temperature Co-efficient of Forward Voltage	$\Delta V_F/\Delta T_A$		-1.25		mV/ $^{\circ}\text{C}$	$I_F = 4\text{ mA}$		4
Input Reverse Breakdown Voltage	BV_R	3	5		V	$I_R = 100\text{ }\mu\text{A}$		4
Input Capacitance	C_{IN}		60		pF	$f = 1\text{ MHz}$, $V_F = 0\text{ V}$		

*All typical values at $T_A = 25^{\circ}\text{C}$, $V_{CC} = 5\text{ V}$

**Single Channel Products only (HCPL-261A/261N/061A/061N)

***Dual Channel Products only (HCPL-263A/263N/063A/063N)

Switching Specifications

Over recommended operating temperature ($T_A = -40^\circ\text{C}$ to $+85^\circ\text{C}$) unless otherwise specified

Parameter	Symbol	Min.	Typ.*	Max.	Units	Test Conditions	Fig.	Note
Input Current Threshold High to Low	I_{THL}		1.5	3.0	mA	$V_{\text{CC}} = 5.5 \text{ V}$, $V_{\text{O}} = 0.6 \text{ V}$, $I_{\text{O}} > 13 \text{ mA}$ (Sinking)	7, 10	18
Propagation Delay Time to High Output Level	t_{PLH}		52	100	ns	$I_{\text{F}} = 3.5 \text{ mA}$ $V_{\text{CC}} = 5.0 \text{ V}$, $V_{\text{E}} = \text{Open}$, $C_{\text{L}} = 15 \text{ pF}$, $R_{\text{L}} = 350 \Omega$	9, 11, 12	4, 9, 18
Propagation Delay Time to Low Output Level	t_{PHL}		53	100	ns		9, 11, 12	4, 10, 18
Pulse Width Distortion	PWD $ t_{\text{PHL}} - t_{\text{PLH}} $		11	45	ns		9, 13	17, 18
Propagation Delay Skew	t_{PSK}			60	ns		24	11, 18
Output Rise Time	t_{R}		42		ns		9, 14	4, 18
Output Fall Time	t_{F}		12		ns		9, 14	4, 18
Propagation Delay Time of Enable from V_{EH} to V_{EL}	t_{EHL}		19		ns	$I_{\text{F}} = 3.5 \text{ mA}$ $V_{\text{CC}} = 5.0 \text{ V}$, $V_{\text{EL}} = 0 \text{ V}$, $V_{\text{EH}} = 3 \text{ V}$, $C_{\text{L}} = 15 \text{ pF}$, $R_{\text{L}} = 350 \Omega$	15, 16	12
Propagation Delay Time of Enable from V_{EL} to V_{EH}	t_{ELH}		30		ns		15, 16	12

*All typical values at $T_A = 25^\circ\text{C}$, $V_{\text{CC}} = 5 \text{ V}$.

Common Mode Transient Immunity Specifications, All values at $T_A = 25^\circ\text{C}$

Parameter	Device	Symbol	Min.	Typ.	Max.	Units	Test Conditions	Fig.	Note
Output High Level Common Mode Transient Immunity	HCPL-261A	$ CM_{\text{H}} $	1	5		kV/ μs	$V_{\text{CM}} = 50 \text{ V}$	17	4, 13, 15, 18
	HCPL-061A								
	HCPL-263A		1	5		kV/ μs	$V_{\text{CM}} = 1000 \text{ V}$	20	4, 13, 15
	HCPL-063A								
	HCPL-261N								
	HCPL-061N								
HCPL-263N	15	25		kV/ μs	Using HP App Circuit				
HCPL-063N									
Output Low Level Common Mode Transient Immunity	HCPL-261A	$ CM_{\text{L}} $	1	5		kV/ μs	$V_{\text{CM}} = 50 \text{ V}$	17	4, 14, 15, 18
	HCPL-061A								
	HCPL-263A		1	5		kV/ μs	$V_{\text{CM}} = 1000 \text{ V}$	20	4, 14, 15
	HCPL-063A								
	HCPL-261N								
	HCPL-061N								
HCPL-263N	15	25		kV/ μs	Using HP App Circuit				
HCPL-063N									

Package Characteristics

All Typicals at $T_A = 25^\circ\text{C}$

Parameter	Sym.	Package*	Min.	Typ.	Max.	Units	Test Conditions	Fig.	Note
Input-Output Momentary Withstand Voltage**	V_{ISO}		2500			V rms	RH \leq 50%, t = 1 min., $T_A = 25^\circ\text{C}$		5, 6
		OPT 020†	5000						5, 7
Input-Output Resistance	R_{I-O}			10^{12}		Ω	$V_{I-O} = 500\text{ Vdc}$		4, 8
Input-Output Capacitance	C_{I-O}			0.6		pF	f = 1 MHz, $T_A = 25^\circ\text{C}$		4, 8
Input-Input Insulation Leakage Current	I_{I-I}	Dual Channel		0.005		μA	RH \leq 45%, t = 5 s, $V_{I-I} = 500\text{ V}$		19
Resistance (Input-Input)	R_{I-I}	Dual Channel		10^{11}		Ω			19
Capacitance (Input-Input)	C_{I-I}	Dual 8-pin DIP		0.03		pF	f = 1 MHz		19
		Dual SO-8		0.25					

*Ratings apply to all devices except otherwise noted in the **Package** column.

**The Input-Output Momentary Withstand Voltage is a dielectric voltage rating that should not be interpreted as an input-output continuous voltage rating. For the continuous voltage rating refer to the VDE 0884 Insulation Characteristics Table (if applicable), your equipment level safety specification or HP Application Note 1074 entitled "Optocoupler Input-Output Endurance Voltage."

†For 8-pin DIP package devices (HCPL-261A/261N/263A/263N) only.

Notes:

- Peaking circuits may be used which produce transient input currents up to 30 mA, 50 ns maximum pulse width, provided the average current does not exceed 10 mA.
- 1 minute maximum.
- Derate linearly above 80°C free-air temperature at a rate of $2.7\text{ mW}/^\circ\text{C}$ for the SOIC-8 package.
- Each channel.
- Device considered a two-terminal device: Pins 1, 2, 3, and 4 shorted together and Pins 5, 6, 7, and 8 shorted together.
- In accordance with UL1577, each optocoupler is proof tested by applying an insulation test voltage $\geq 3000 V_{RMS}$ for 1 second (leakage detection current limit, $I_{I-I} \leq 5\ \mu\text{A}$). This test is performed before the 100% production test for partial discharge (method b) shown in the VDE 0884 Insulation Characteristics Table, if applicable.
- In accordance with UL1577, each optocoupler is proof tested by applying an insulation test voltage $\geq 6000 V_{RMS}$ for 1 second (leakage detection current limit, $I_{I-O} \leq 5\ \mu\text{A}$).
- Measured between the LED anode and cathode shorted together and pins 5 through 8 shorted together.
- The t_{PLH} propagation delay is measured from the 1.75 mA point on the falling edge of the input pulse to the 1.5 V point on the rising edge of the output pulse.
- The t_{PHL} propagation delay is measured from the 1.75 mA point on the rising edge of the input pulse to the 1.5 V point on the falling edge of the output pulse.
- Propagation delay skew (t_{PSK}) is equal to the worst case difference in t_{PLH} and/or t_{PHL} that will be seen between any two units under the same test conditions and operating temperature.
- Single channel products only (HCPL-261A/261N/061A/061N).
- Common mode transient immunity in a Logic High level is the maximum tolerable $|dV_{CM}/dt|$ of the common mode pulse, V_{CM} , to assure that the output will remain in a Logic High state (i.e., $V_O > 2.0\text{ V}$).
- Common mode transient immunity in a Logic Low level is the maximum tolerable $|dV_{CM}/dt|$ of the common mode pulse, V_{CM} , to assure that the output will remain in a Logic Low state (i.e., $V_O < 0.8\text{ V}$).
- For sinusoidal voltages $(|dV_{CM}/dt|)_{max} = \pi f_{CM} V_{CM(P-P)}$.
- Bypassing of the power supply line is required with a $0.1\ \mu\text{F}$ ceramic disc capacitor adjacent to each optocoupler as shown in Figure 19. Total lead length between both ends of the capacitor and the isolator pins should not exceed 10 mm.
- Pulse Width Distortion (PWD) is defined as the difference between t_{PLH} and t_{PHL} for any given device.
- No external pull up is required for a high logic state on the enable input of a single channel product. If the V_E pin is not used, tying V_E to V_{CC} will result in improved CMR performance.
- Measured between pins 1 and 2 shorted together, and pins 3 and 4 shorted together. For dual channel parts only.

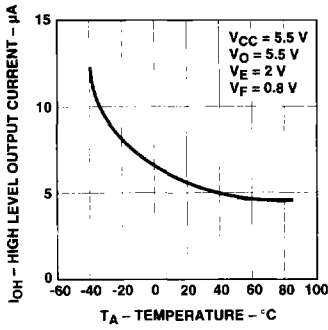

Figure 4. Typical High Level Output Current vs. Temperature.

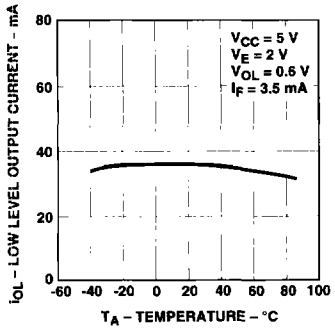

Figure 5. Low Level Output Current vs. Temperature.

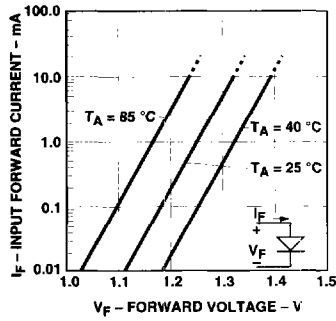

Figure 6. Typical Diode Input Forward Current Characteristic.

HCPL-261A fig 5

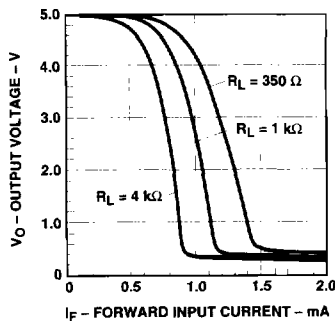

Figure 7. Typical Output Voltage vs. Forward Input Current.

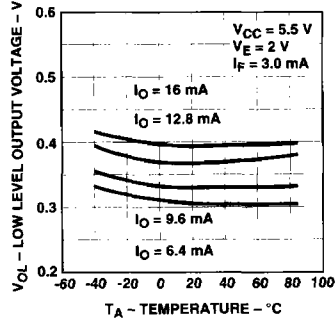
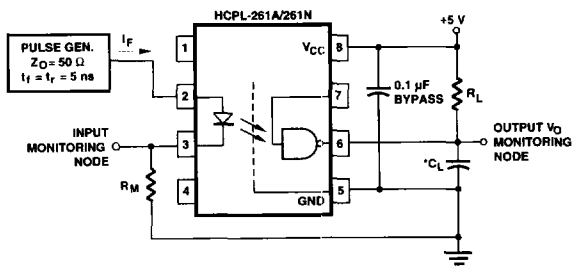

Figure 8. Typical Low Level Output Voltage vs. Temperature.



*CL IS APPROXIMATELY 15 pF WHICH INCLUDES PROBE AND STRAY WIRING CAPACITANCE.

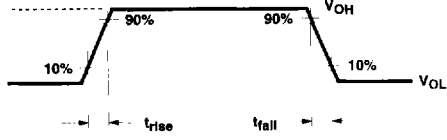
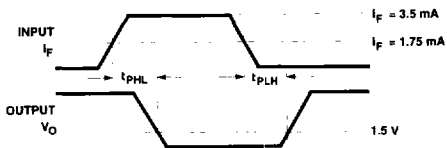

Figure 9. Test Circuit for t_{PHL} and t_{PLH} .

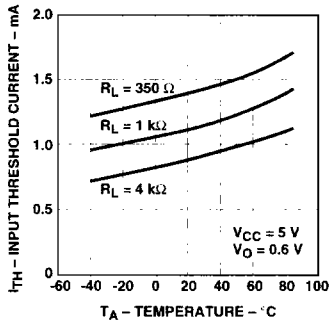

Figure 10. Typical Input Threshold Current vs. Temperature.

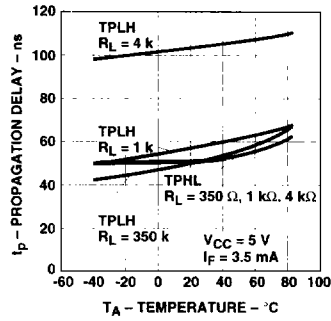

Figure 11. Typical Propagation Delay vs. Temperature.

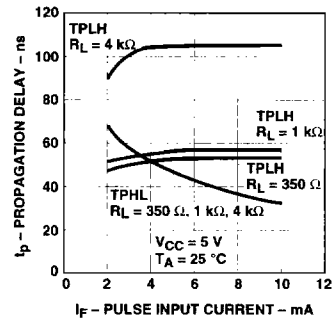

Figure 12. Typical Propagation Delay vs. Pulse Input Current.

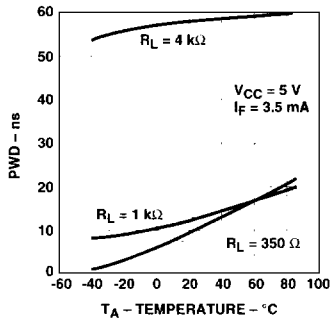

Figure 13. Typical Pulse Width Distortion vs. Temperature.

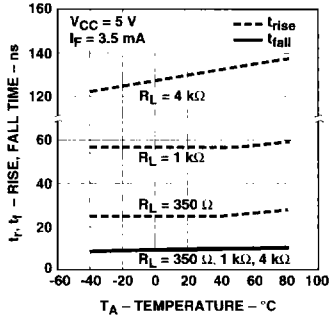

Figure 14. Typical Rise and Fall Time vs. Temperature.

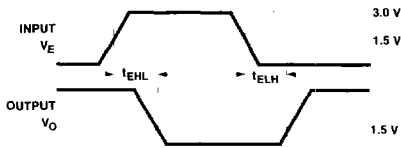
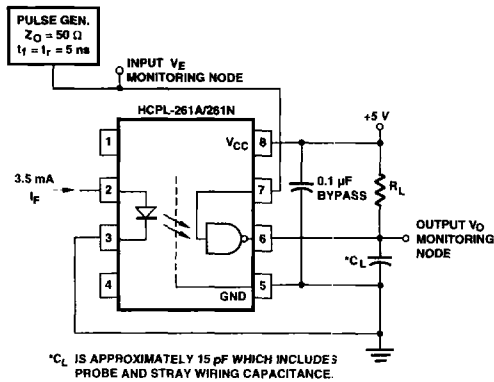

Figure 15. Test Circuit for t_{EHL} and t_{ELH} .

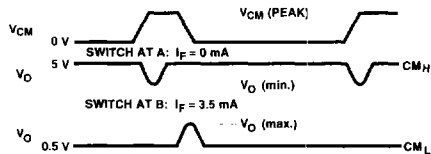
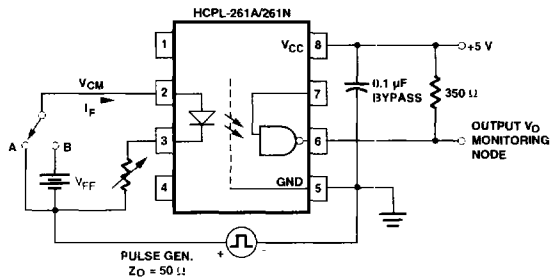

Figure 17. Test Circuit for Common Mode Transient Immunity and Typical Waveforms.

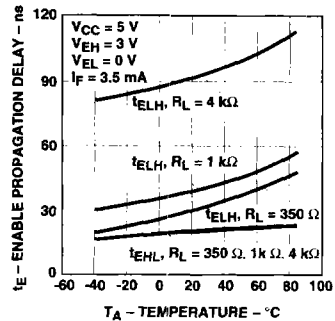

Figure 16. Typical Enable Propagation Delay vs. Temperature. HCPL-261A/-261N/-061A/-061N Only.

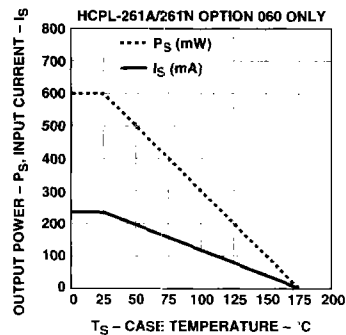

Figure 18. Thermal Derating Curve, Dependence of Safety Limiting Value with Case Temperature per VDE 0884.

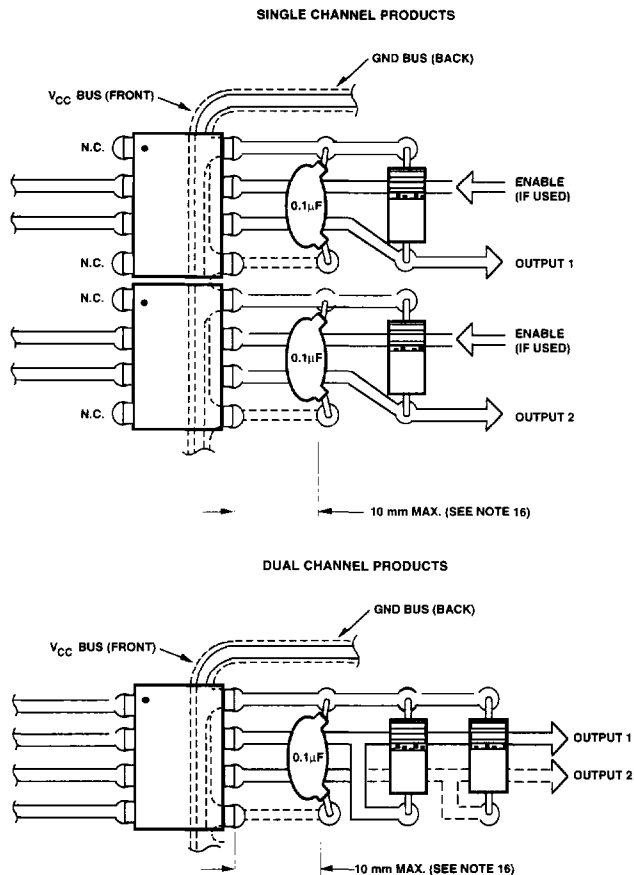
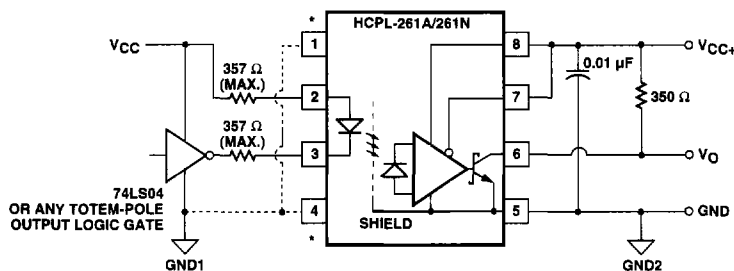

Figure 19. Recommended Printed Circuit Board Layout.



* HIGHER CMR MAY BE OBTAINABLE BY CONNECTING PINS 1, 4 TO INPUT GROUND (GND1).

Figure 20. Recommended Drive Circuit for HCPL-261A/-261N Families for High-CMR (Similar for HCPL-263A/-263N).

*Higher CMR May Be Obtainable by Connecting Pins 1, 4 to Input Ground (Gnd1).

Application Information Common-Mode Rejection for HCPL-261A/HCPL-261N Families:

Figure 20 shows the recommended drive circuit for the HCPL-261N/-261A for optimal common-mode rejection performance. Two main points to note are:

1. The enable pin is tied to V_{CC} rather than floating (this applies to single-channel parts only).
2. Two LED-current setting resistors are used instead of one. This is to balance I_{LED} variation during common-mode transients.

If the enable pin is left floating, it is possible for common-mode transients to couple to the enable pin, resulting in common-mode failure. This failure mechanism only occurs when the LED is on and the output is in the Low State. It is identified as occurring when the transient output voltage rises above 0.8 V. Therefore, the enable pin should be connected to either V_{CC} or logic-level high for best common-mode performance with the output low (CMR_L). This failure mechanism is only present in single-channel parts (HCPL-261N, -261A, -061N, -061A) which have the enable function.

Also, common-mode transients can capacitively couple from the LED anode (or cathode) to the output-side ground causing current to be shunted away from the LED (which can be bad if the LED is on) or conversely cause current to be injected into the LED (bad if the LED is meant to be off). Figure 21 shows the parasitic capacitances which exists between LED

anode/cathode and output ground (C_{LA} and C_{LC}). Also shown in Figure 21 on the input side is an AC-equivalent circuit. Table 1 indicates the directions of I_{LP} and I_{LN} flow depending on the direction of the common-mode transient.

For transients occurring when the LED is on, common-mode rejection (CMR_L , since the output is in the "low" state) depends upon the amount of LED current drive (I_F). For conditions where I_F is close to the switching threshold (I_{TH}), CMR_L also depends on the extent which I_{LP} and I_{LN} balance each other. In other words, any condition where common-mode transients cause a momentary decrease in I_F (i.e. when $dV_{CM}/dt > 0$ and $|I_{FP}| > |I_{FN}|$, referring to Table 1) will cause common-mode failure for transients which are fast enough.

Likewise for common-mode transients which occur when the LED is off (i.e. CMR_H , since the output is "high"), if an imbalance between I_{LP} and I_{LN} results in a transient I_F equal to or greater than the switching threshold of the optocoupler, the transient "signal" may cause the output to spike below 2 V (which constitutes a CMR_H failure).

By using the recommended circuit in Figure 20, good CMR can be achieved. (In the case of the -261N families, a minimum CMR of 15 kV/ μ s is guaranteed using this circuit.) The balanced I_{LED} -setting resistors help equalize I_{LP} and I_{LN} to reduce the amount by which I_{LED} is modulated from transient coupling through C_{LA} and C_{LC} .

CMR with Other Drive Circuits

CMR performance with drive circuits other than that shown in Figure 20 may be enhanced by following these guidelines:

1. Use of drive circuits where current is shunted from the LED in the LED "off" state (as shown in Figures 22 and 23). This is beneficial for good CMR_H .
2. Use of $I_{FH} > 3.5$ mA. This is good for high CMR_L .

Using any one of the drive circuits in Figures 22-24 with $I_F = 10$ mA will result in a typical CMR of 8 kV/ μ s for the HCPL-261N family, as long as the PC board layout practices are followed. Figure 22 shows a

circuit which can be used with any totem-pole-output TTL/LSTTL/HCMOS logic gate. The buffer PNP transistor allows the circuit to be used with logic devices which have low current-sinking capability. It also helps maintain the driving-gate power-supply current at a constant level to minimize ground shifting for other devices connected to the input-supply ground.

When using an open-collector TTL or open-drain CMOS logic gate, the circuit in Figure 23 may be used. When using a CMOS gate to drive the optocoupler, the circuit shown in Figure 24 may be used. The diode in parallel with the R_{LED} speeds the turn-off of the optocoupler LED.

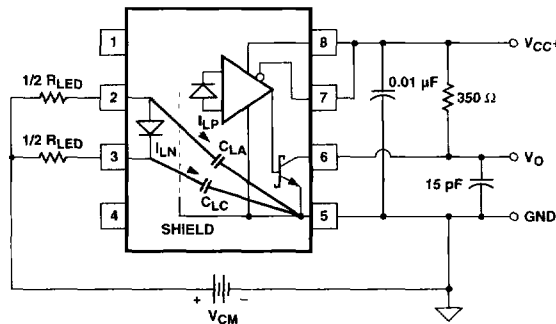

Figure 21. AC Equivalent Circuit for HCPL-261X.

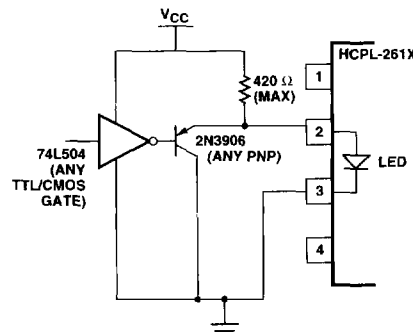

Figure 22. TTL Interface Circuit for the HCPL-261A/-261N Families.

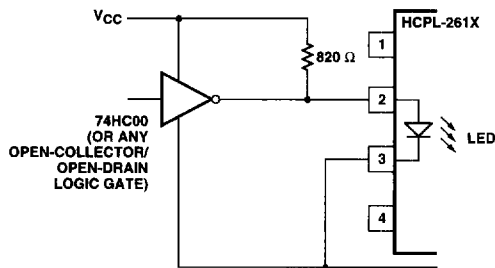

Figure 23. TTL Open-Collector/Open Drain Gate Drive Circuit for HCPL-261A/-261N Families.

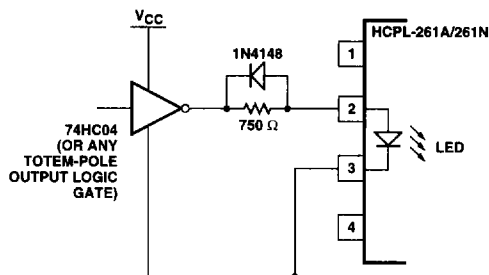

Figure 24. CMOS Gate Drive Circuit for HCPL-261A/-261N Families.

Table 1. Effects of Common Mode Pulse Direction on Transient I_{LED}

If dV_{CM}/dt Is:	then I_{LP} Flows:	and I_{LN} Flows:	If $ I_{LP} < I_{LN} $, LED I_F Current Is Momentarily:	If $ I_{LP} > I_{LN} $, LED I_F Current Is Momentarily:
positive (>0)	away from LED anode through C_{LA}	away from LED cathode through C_{LC}	increased	decreased
negative (<0)	toward LED anode through C_{LA}	toward LED cathode through C_{LC}	decreased	increased

Propagation Delay, Pulse-Width Distortion and Propagation Delay Skew

Propagation delay is a figure of merit which describes how quickly a logic signal propagates through a system. The propagation delay from low to high (t_{PLH}) is the amount of time required for an input signal to propagate to the output, causing the output to change from low to high. Similarly, the propagation delay from high to low (t_{PHL}) is the amount of time required for the input signal to propagate to the output, causing the output to change from high to low (see Figure 9).

Pulse-width distortion (PWD) results when t_{PLH} and t_{PHL} differ in value. PWD is defined as the difference between t_{PLH} and t_{PHL} and often determines the

maximum data rate capability of a transmission system. PWD can be expressed in percent by dividing the PWD (in ns) by the minimum pulse width (in ns) being transmitted. Typically, PWD on the order of 20-30% of the minimum pulse width is tolerable; the exact figure depends on the particular application (RS232, RS422, T-1, etc.).

Propagation delay skew, t_{PSK} , is an important parameter to consider in parallel data applications where synchronization of signals on parallel data lines is a concern. If the parallel data is being sent through a group of optocouplers, differences in propagation delays will cause the data to arrive at the outputs of the optocouplers at different times. If this difference in propagation delay is large enough it will determine the

maximum rate at which parallel data can be sent through the optocouplers.

Propagation delay skew is defined as the difference between the minimum and maximum propagation delays, either t_{PLH} or t_{PHL} , for any given group of optocouplers which are operating under the same conditions (i.e., the same drive current, supply voltage, output load, and operating temperature). As illustrated in Figure 25, if the inputs of a group of optocouplers are switched either ON or OFF at the same time, t_{PSK} is the difference between the shortest propagation delay, either t_{PLH} or t_{PHL} , and the longest propagation delay, either t_{PLH} or t_{PHL} .

As mentioned earlier, t_{PSK} can determine the maximum parallel

data transmission rate. Figure 26 is the timing diagram of a typical parallel data application with both the clock and the data lines being sent through optocouplers. The figure shows data and clock signals at the inputs and outputs of the optocouplers. To obtain the maximum data transmission rate, both edges of the clock signal are being used to clock the data; if only one edge were used, the clock signal would need to be twice as fast.

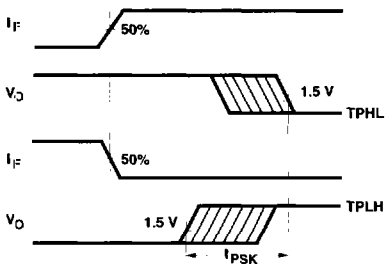

Figure 25. Illustration of Propagation Delay Skew – t_{PSK} .

Propagation delay skew represents the uncertainty of when an edge might be after being sent through an optocoupler. Figure 26 shows that there will be uncertainty in both the data and the clock lines. It is important that these two areas of uncertainty not overlap, otherwise the clock signal might arrive before all of the data outputs have settled, or some of the data outputs may start to change before the clock signal has arrived. From these considerations, the absolute minimum pulse width that can be sent through optocouplers in a parallel application is twice t_{PSK} . A cautious design should use a slightly longer pulse width to ensure that any additional uncertainty in the rest of the circuit does not cause a problem.

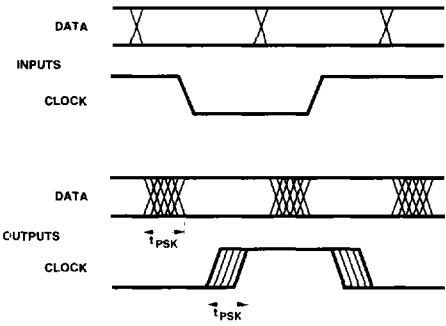

Figure 26. Parallel Data Transmission Example.

The t_{PSK} specified optocouplers offer the advantages of guaranteed specifications for propagation delays, pulse-width distortion, and propagation delay skew over the recommended temperature, input current, and power supply ranges.