



## UR6225

CMOS IC

### POSITIVE VOLTAGE REGULATOR

#### DESCRIPTION

The UTC **UR6225** is a positive voltage output, three-pin regulator that provides a high current even when the input/output voltage differential is small. Low power consumption and high accuracy is achieved through CMOS and laser trimming technologies.

The UTC **UR6225** consists of a high-precision voltage reference, an error amplification circuit, and a current limited output driver. Transient responses to load variations have improved in comparison to the existing series.

#### FEATURES

- \* Maximum Output Current: 300mA  
(Within Max. Power Dissipation,  $V_{OUT} = 5.0V$ )
- \* Output Voltage Range: 1.2V ~ 6.0V in 0.1V Increments  
(1.2V ~ 1.9V for Custom Products)
- \* Highly Accurate: Output Voltage  $\pm 2\%$   
( $\pm 1\%$  for Semi-Custom Products)
- \* Low Power Consumption: Typ.  $2.0\mu A @ V_{OUT}=5.0V$
- \* Output Voltage Temperature Characteristics :  
Typ.  $\pm 100ppm/^{\circ}C$
- \* Input Stability : Typ.  $0.2\%/V$
- \* Small Input-Output Differential :  
 $I_{OUT} = 100mA @ V_{OUT} = 5.0V$  with a 0.12V Differential.
- \* Over Temperature Protection

#### ORDERING INFORMATION

Ordering Number		Package	Pin Assignment					Packing
Lead Free	Halogen Free		1	2	3	4	5	
UR6225L-xx-AB3-C-R	UR6225G-xx-AB3-C-R	SOT-89	G	I	O	-	-	Tape Reel
UR6225L-xx-AE3-3-R	UR6225G-xx-AE3-3-R	SOT-23	O	G	I	-	-	Tape Reel
UR6225L-xx-AF5-C-R	UR6225G-xx-AF5-C-R	SOT-25	I	G	N	N	O	Tape Reel
UR6225L-xx-AF5-F-R	UR6225G-xx-AF5-F-R	SOT-25	G	I	O	N	N	Tape Reel
UR6225L-xx-T92-C-K	UR6225G-xx-T92-C-K	TO-92	G	I	O	-	-	Bulk
UR6225L-xx-T92-C-B	UR6225G-xx-T92-C-B	TO-92	G	I	O	-	-	Tape Box
UR6225L-xx-T92-B-K	UR6225G-xx-T92-B-K	TO-92	O	G	I	-	-	Bulk
UR6225L-xx-T92-B-B	UR6225G-xx-T92-B-B	TO-92	O	G	I	-	-	Tape Box

Note: Pin Assignment: I:  $V_{IN}$  O:  $V_{OUT}$  G:  $V_{SS}$  N: No Connection  
xx: Output Voltage, refer to Marking Information.

<p>UR6225L-xx-AB3-3-R</p>	<p>(1) R:Tape Reel, K:Bulk, B:Tape Box (2) refer to Pin Assignment (3) AB3:SOT-89, AE3:SOT-23, AF5:SOT-25, T92:TO-92 (4) xx:refer to Marking Information (5) G: Halogen Free, L: Lead Free</p>
---------------------------	--

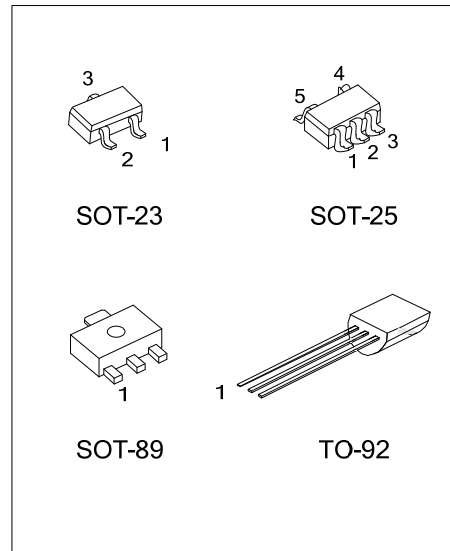

## MARKING INFORMATION

PACKAGE	VOLTAGE CODE	MARKING
SOT-89	12:1.2V 13:1.3V 15:1.5V	<p>Date Code ← UR6225 → Voltage Code L: Lead Free G: Halogen Free</p>
SOT-25	18:1.8V 20:2.0V 21:2.1V 25:2.5V 26:2.6V 27:2.7V 28:2.8V	<p>Voltage Code ← F2XX → Pin Code L: Lead Free G: Halogen Free</p>
SOT-23	2J:2.85V 30:3.0V 33:3.3V 35:3.5V 36:3.6V 38:3.8V	<p>Voltage Code ← F2XX → L: Lead Free G: Halogen Free</p>
TO-92	40:4.0V 45:4.5V 50:5.0V 60:6.0V	<p>Pin Code ← UTC UR6225 → L: Lead Free G: Halogen Free Voltage Code ← → Date Code</p>

■ BLOCK DIAGRAM

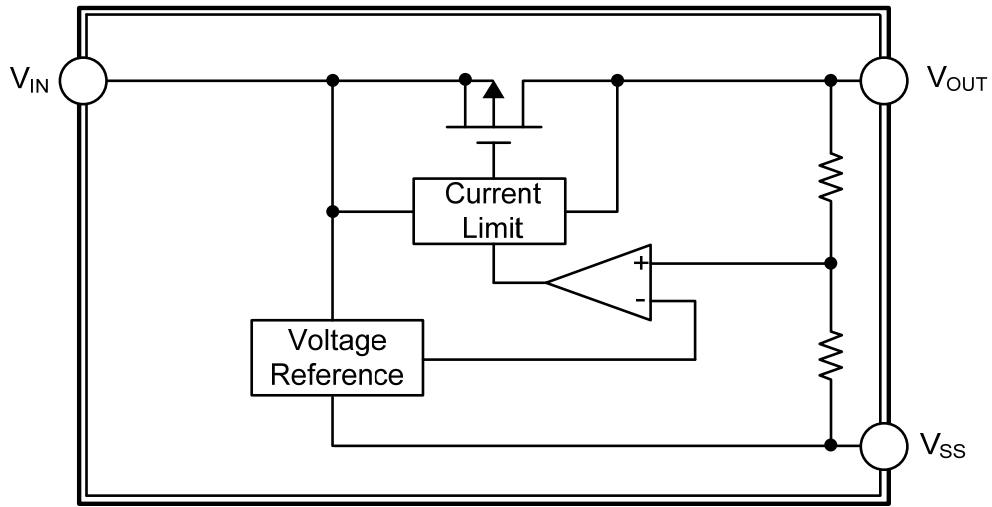

■ ABSOLUTE MAXIMUM RATINGS ( $T_A=25^\circ\text{C}$ )

PARAMETER	SYMBOL	RATINGS	UNIT
Input Voltage	$V_{IN}$	10	V
Output Current	$I_{OUT}$	300	mA
Output Voltage	$V_{OUT}$	$V_{SS}-0.3 \sim V_{IN}+0.3$	V
Power Dissipation	SC-23/SOT-25	250	mW
	SOT-89	500	mW
	TO-92	300	mW
Junction Temperature	$T_J$	+125	$^\circ\text{C}$
Operating Temperature	$T_{OPR}$	-40 ~ +85	$^\circ\text{C}$
Storage Temperature	$T_{STG}$	-40~+125	$^\circ\text{C}$

Note: Absolute maximum ratings are those values beyond which the device could be permanently damaged.

Absolute maximum ratings are stress ratings only and functional device operation is not implied.

■ ELECTRICAL CHARACTERISTICS ( $T_a=25^\circ\text{C}$ , unless otherwise specified)

**UR6225-6.0V (Note1)**

PARAMETER	CIRCUIT	SYMBOL	TEST CONDITIONS	MIN	TYP	MAX	UNIT
Output Voltage	1	$V_{OUT(E)}$ (Note2)	$I_{OUT}=50\mu\text{A}\sim 40\text{mA}$ , $V_{IN}=7.0\text{V}$	5.880	6.000	6.120	V
Maximum Output Current	1	$I_{OUT(MAX)}$	$V_{IN}=7.0\text{V}$ , $V_{OUT(E)}\geq 5.4\text{V}$	250			mA
Minimum Load Current		$I_{OUT(MIN)}$	$V_{IN}=V_{OUT}+1\text{V}$			50	$\mu\text{A}$
Load Stability	1	$\Delta V_{OUT}$	$V_{IN}=7.0\text{V}$ $1\text{mA}\leq I_{OUT}\leq 100\text{mA}$		40	80	mV
Input-Output Voltage Differential(Note3)	1	$V_{DIF1}$	$I_{OUT}=100\text{mA}$		120	300	mV
	1	$V_{DIF2}$	$I_{OUT}=200\text{mA}$		380	600	mV
Supply Current	2	$I_{SS}$	$V_{IN}=7.0\text{V}$		2.0	4.5	$\mu\text{A}$
Input Stability	1	$\frac{\Delta V_{OUT}}{\Delta V_{IN} \times V_{OUT}}$	$I_{OUT}=40\text{mA}$ $7.0\text{V}\leq V_{IN}\leq 10\text{V}$		0.2	0.3	%/V
Input Voltage		$V_{IN}$	$I_{OUT}=5\text{mA}$			10	V
Thermal Shutdown					150		$^\circ\text{C}$
Output Voltage Temperature Characteristics	1	$\frac{\Delta V_{OUT}}{\Delta T_{OPR} \times V_{OUT}}$	$I_{OUT}=40\text{mA}$ $-40^\circ\text{C}\leq T_{OPR}\leq 85^\circ\text{C}$		$\pm 100$		ppm/ $^\circ\text{C}$

**UR6225-5.0V (Note1)**

PARAMETER	CIRCUIT	SYMBOL	TEST CONDITONS	MIN	TYP	MAX	UNIT
Output Voltage	1	$V_{OUT(E)}$ (Note2)	$I_{OUT}=50\mu\text{A}\sim 40\text{mA}$ , $V_{IN}=6.0\text{V}$	4.900	5.000	5.100	V
Maximum Output Current	1	$I_{OUT(MAX)}$	$V_{IN}=6.0\text{V}$ , $V_{OUT(E)}\geq 4.5\text{V}$	250			mA
Minimum Load Current		$I_{OUT(MIN)}$	$V_{IN}=V_{OUT}+1\text{V}$			50	$\mu\text{A}$
Load Stability	1	$\Delta V_{OUT}$	$V_{IN}=6.0\text{V}$ $1\text{mA}\leq I_{OUT}\leq 100\text{mA}$		40	80	mV
Input-Output Voltage Differential(Note3)	1	$V_{DIF1}$	$I_{OUT}=100\text{mA}$		120	300	mV
	1	$V_{DIF2}$	$I_{OUT}=200\text{mA}$		380	600	mV
Supply Current	2	$I_{SS}$	$V_{IN}=6.0\text{V}$		2.0	4.5	$\mu\text{A}$
Input Stability	1	$\frac{\Delta V_{OUT}}{\Delta V_{IN} \times V_{OUT}}$	$I_{OUT}=40\text{mA}$ $6.0\text{V}\leq V_{IN}\leq 10\text{V}$		0.2	0.3	%/V
Input Voltage		$V_{IN}$	$I_{OUT}=5\text{mA}$			10	V
Thermal Shutdown					150		$^\circ\text{C}$
Output Voltage Temperature Characteristics	1	$\frac{\Delta V_{OUT}}{\Delta T_{OPR} \times V_{OUT}}$	$I_{OUT}=40\text{mA}$ $-40^\circ\text{C}\leq T_{OPR}\leq 85^\circ\text{C}$		$\pm 100$		ppm/ $^\circ\text{C}$

■ ELECTRICAL CHARACTERISTICS(Cont.)

**UR6225-4.5V (Note1)**

PARAMETER	CIRCUIT	SYMBOL	TEST CONDITONS	MIN	TYP	MAX	UNIT
Output Voltage	1	$V_{OUT(E)}$ (Note2)	$I_{OUT}=50\mu A\sim 40mA$ , $V_{IN}=5.5V$	4.410	4.500	4.59	V
Maximum Output Current	1	$I_{OUT(MAX)}$	$V_{IN}=5.5V$ , $V_{OUT(E)}\geq 4.05V$	200			mA
Minimum Load Current		$I_{OUT(MIN)}$	$V_{IN}=V_{OUT}+1V$			50	$\mu A$
Load Stability	1	$\Delta V_{OUT}$	$V_{IN}=5.5V$ $1mA\leq I_{OUT}\leq 100mA$		45	90	mV
Input-Output Voltage Differential(Note3)	1	$V_{DIF1}$	$I_{OUT}=100mA$		170	330	mV
	1	$V_{DIF2}$	$I_{OUT}=200mA$		400	630	mV
Supply Current	2	$I_{SS}$	$V_{IN}=5.5V$		2.0	4.5	$\mu A$
Input Stability	1	$\frac{\Delta V_{OUT}}{\Delta V_{IN} \times V_{OUT}}$	$I_{OUT}=40mA$ $5.5V\leq V_{IN}\leq 10V$		0.2	0.3	%/V
Input Voltage		$V_{IN}$	$I_{OUT}=5mA$			10	V
Thermal Shutdown					150		$^{\circ}C$
Output Voltage Temperature Characteristics	1	$\frac{\Delta V_{OUT}}{\Delta T_{OPR} \times V_{OUT}}$	$I_{OUT}=40mA$ $-40^{\circ}C\leq T_{OPR}\leq 85^{\circ}C$		$\pm 100$		ppm/ $^{\circ}C$

**UR6225-4.0V (Note1)**

PARAMETER	CIRCUIT	SYMBOL	TEST CONDITONS	MIN	TYP	MAX	UNIT
Output Voltage	1	$V_{OUT(E)}$ (Note2)	$I_{OUT}=50\mu A\sim 40mA$ , $V_{IN}=5.0V$	3.920	4.000	4.080	V
Maximum Output Current	1	$I_{OUT(MAX)}$	$V_{IN}=5.0V$ , $V_{OUT(E)}\geq 3.6V$	200			mA
Minimum Load Current		$I_{OUT(MIN)}$	$V_{IN}=V_{OUT}+1V$			50	$\mu A$
Load Stability	1	$\Delta V_{OUT}$	$V_{IN}=5.0V$ $1mA\leq I_{OUT}\leq 100mA$		45	90	mV
Input-Output Voltage Differential(Note3)	1	$V_{DIF1}$	$I_{OUT}=100mA$		170	330	mV
	1	$V_{DIF2}$	$I_{OUT}=200mA$		400	630	mV
Supply Current	2	$I_{SS}$	$V_{IN}=5.0V$		2.0	4.5	$\mu A$
Input Stability	1	$\frac{\Delta V_{OUT}}{\Delta V_{IN} \times V_{OUT}}$	$I_{OUT}=40mA$ $5.0V\leq V_{IN}\leq 10V$		0.2	0.3	%/V
Input Voltage		$V_{IN}$	$I_{OUT}=5mA$			10	V
Thermal Shutdown					150		$^{\circ}C$
Output Voltage Temperature Characteristics	1	$\frac{\Delta V_{OUT}}{\Delta T_{OPR} \times V_{OUT}}$	$I_{OUT}=40mA$ $-40^{\circ}C\leq T_{OPR}\leq 85^{\circ}C$		$\pm 100$		ppm/ $^{\circ}C$

**UR6225-3.8V (Note1)**

PARAMETER	CIRCUIT	SYMBOL	TEST CONDITONS	MIN	TYP	MAX	UNIT
Output Voltage	1	$V_{OUT(E)}$ (Note2)	$I_{OUT}=50\mu A\sim 40mA$ , $V_{IN}=4.8V$	3.724	3.800	3.876	V
Maximum Output Current	1	$I_{OUT(MAX)}$	$V_{IN}=4.8V$ , $V_{OUT(E)}\geq 3.42V$	165			mA
Minimum Load Current		$I_{OUT(MIN)}$	$V_{IN}=V_{OUT}+1V$			50	$\mu A$
Load Stability	1	$\Delta V_{OUT}$	$V_{IN}=4.8V$ $1mA\leq I_{OUT}\leq 86mA$		45	90	mV
Input-Output Voltage Differential(Note3)	1	$V_{DIF1}$	$I_{OUT}=86mA$		180	360	mV
	1	$V_{DIF2}$	$I_{OUT}=172mA$		400	700	mV
Supply Current	2	$I_{SS}$	$V_{IN}=4.8V$		2.0	4.5	$\mu A$
Input Stability	1	$\frac{\Delta V_{OUT}}{\Delta V_{IN} \times V_{OUT}}$	$I_{OUT}=40mA$ $4.8V\leq V_{IN}\leq 10V$		0.2	0.3	%/V
Input Voltage		$V_{IN}$	$I_{OUT}=5mA$			10	V
Thermal Shutdown					150		$^{\circ}C$
Output Voltage Temperature Characteristics	1	$\frac{\Delta V_{OUT}}{\Delta T_{OPR} \times V_{OUT}}$	$I_{OUT}=40mA$ $-40^{\circ}C\leq T_{OPR}\leq 85^{\circ}C$		$\pm 100$		ppm/ $^{\circ}C$

■ ELECTRICAL CHARACTERISTICS(Cont.)

**UR6225-3.6V (Note1)**

PARAMETER	CIRCUIT	SYMBOL	TEST CONDITONS	MIN	TYP	MAX	UNIT
Output Voltage	1	$V_{OUT(E)}$ (Note2)	$I_{OUT}=50\mu A \sim 40mA, V_{IN}=4.6V$	3.528	3.600	3.672	V
Maximum Output Current	1	$I_{OUT(MAX)}$	$V_{IN}=4.6V, V_{OUT(E)} \geq 3.24V$	165			mA
Minimum Load Current		$I_{OUT(MIN)}$	$V_{IN}=V_{OUT}+1V$			50	$\mu A$
Load Stability	1	$\Delta V_{OUT}$	$V_{IN}=4.6V$ $1mA \leq I_{OUT} \leq 86mA$		45	90	mV
Input-Output Voltage Differential(Note3)	1	$V_{DIF1}$	$I_{OUT}=86mA$		180	360	mV
	1	$V_{DIF2}$	$I_{OUT}=172mA$		400	700	mV
Supply Current	2	$I_{SS}$	$V_{IN}=4.6V$		2.0	4.5	$\mu A$
Input Stability	1	$\frac{\Delta V_{OUT}}{\Delta V_{IN} \times V_{OUT}}$	$I_{OUT}=40mA$ $4.6V \leq V_{IN} \leq 10V$		0.2	0.3	%/V
Input Voltage		$V_{IN}$	$I_{OUT}=5mA$			10	V
Thermal Shutdown					150		$^{\circ}C$
Output Voltage Temperature Characteristics	1	$\frac{\Delta V_{OUT}}{\Delta T_{OPR} \times V_{OUT}}$	$I_{OUT}=40mA$ $-40^{\circ}C \leq T_{OPR} \leq 85^{\circ}C$		$\pm 100$		ppm/ $^{\circ}C$

**UR6225-3.5V (Note1)**

PARAMETER	CIRCUIT	SYMBOL	TEST CONDITONS	MIN	TYP	MAX	UNIT
Output Voltage	1	$V_{OUT(E)}$ (Note2)	$I_{OUT}=50\mu A \sim 40mA, V_{IN}=4.5V$	3.430	3.500	3.570	V
Maximum Output Current	1	$I_{OUT(MAX)}$	$V_{IN}=4.5V, V_{OUT(E)} \geq 3.15V$	165			mA
Minimum Load Current		$I_{OUT(MIN)}$	$V_{IN}=V_{OUT}+1V$			50	$\mu A$
Load Stability	1	$\Delta V_{OUT}$	$V_{IN}=4.5V$ $1mA \leq I_{OUT} \leq 86mA$		45	90	mV
Input-Output Voltage Differential(Note3)	1	$V_{DIF1}$	$I_{OUT}=86mA$		180	360	mV
	1	$V_{DIF2}$	$I_{OUT}=172mA$		400	700	mV
Supply Current	2	$I_{SS}$	$V_{IN}=4.5V$		2.0	4.5	$\mu A$
Input Stability	1	$\frac{\Delta V_{OUT}}{\Delta V_{IN} \times V_{OUT}}$	$I_{OUT}=40mA$ $4.5V \leq V_{IN} \leq 10V$		0.2	0.3	%/V
Input Voltage		$V_{IN}$	$I_{OUT}=5mA$			10	V
Thermal Shutdown					150		$^{\circ}C$
Output Voltage Temperature Characteristics	1	$\frac{\Delta V_{OUT}}{\Delta T_{OPR} \times V_{OUT}}$	$I_{OUT}=40mA$ $-40^{\circ}C \leq T_{OPR} \leq 85^{\circ}C$		$\pm 100$		ppm/ $^{\circ}C$

**UR6225-3.3V (Note1)**

PARAMETER	CIRCUIT	SYMBOL	TEST CONDITONS	MIN	TYP	MAX	UNIT
Output Voltage	1	$V_{OUT(E)}$ (Note2)	$I_{OUT}=50\mu A \sim 40mA, V_{IN}=4.3V$	3.234	3.300	3.366	V
Maximum Output Current	1	$I_{OUT(MAX)}$	$V_{IN}=4.3V, V_{OUT(E)} \geq 2.97V$	165			mA
Minimum Load Current		$I_{OUT(MIN)}$	$V_{IN}=V_{OUT}+1V$			50	$\mu A$
Load Stability	1	$\Delta V_{OUT}$	$V_{IN}=4.3V$ $1mA \leq I_{OUT} \leq 86mA$		45	90	mV
Input-Output Voltage Differential(Note3)	1	$V_{DIF1}$	$I_{OUT}=86mA$		180	360	mV
	1	$V_{DIF2}$	$I_{OUT}=172mA$		400	700	mV
Supply Current	2	$I_{SS}$	$V_{IN}=4.3V$		2.0	4.5	$\mu A$
Input Stability	1	$\frac{\Delta V_{OUT}}{\Delta V_{IN} \times V_{OUT}}$	$I_{OUT}=40mA$ $4.3V \leq V_{IN} \leq 10V$		0.2	0.3	%/V
Input Voltage		$V_{IN}$	$I_{OUT}=5mA$			10	V
Thermal Shutdown					150		$^{\circ}C$
Output Voltage Temperature Characteristics	1	$\frac{\Delta V_{OUT}}{\Delta T_{OPR} \times V_{OUT}}$	$I_{OUT}=40mA$ $-40^{\circ}C \leq T_{OPR} \leq 85^{\circ}C$		$\pm 100$		ppm/ $^{\circ}C$

■ ELECTRICAL CHARACTERISTICS(Cont.)

**UR6225-3.0V (Note1)**

PARAMETER	CIRCUIT	SYMBOL	TEST CONDITONS	MIN	TYP	MAX	UNIT
Output Voltage	1	$V_{OUT(E)}$ (Note2)	$I_{OUT}=50\mu A \sim 40mA, V_{IN}=4.0V$	2.940	3.000	3.060	V
Maximum Output Current	1	$I_{OUT(MAX)}$	$V_{IN}=4.0V, V_{OUT(E)} \geq 2.7V$	150			mA
Minimum Load Current		$I_{OUT(MIN)}$	$V_{IN}=V_{OUT}+1V$			50	$\mu A$
Load Stability	1	$\Delta V_{OUT}$	$V_{IN}=4.0V$ $1mA \leq I_{OUT} \leq 80mA$		45	90	mV
Input-Output Voltage Differential(Note3)	1	$V_{DIF1}$	$I_{OUT}=80mA$		180	360	mV
	1	$V_{DIF2}$	$I_{OUT}=160mA$		400	700	mV
Supply Current	2	$I_{SS}$	$V_{IN}=4.0V$		2.0	4.5	$\mu A$
Input Stability	1	$\frac{\Delta V_{OUT}}{\Delta V_{IN} \times V_{OUT}}$	$I_{OUT}=40mA$ $4.0V \leq V_{IN} \leq 10V$		0.2	0.3	%/V
Input Voltage		$V_{IN}$	$I_{OUT}=5mA$			10	V
Thermal Shutdown					150		$^{\circ}C$
Output Voltage Temperature Characteristics	1	$\frac{\Delta V_{OUT}}{\Delta T_{OPR} \times V_{OUT}}$	$I_{OUT}=40mA$ $-40^{\circ}C \leq T_{OPR} \leq 85^{\circ}C$		$\pm 100$		ppm/ $^{\circ}C$

**UR6225-2.85V (Note1)**

PARAMETER	CIRCUIT	SYMBOL	TEST CONDITONS	MIN	TYP	MAX	UNIT
Output Voltage	1	$V_{OUT(E)}$ (Note2)	$I_{OUT}=50\mu A \sim 40mA, V_{IN}=3.85V$	2.793	2.85	2.907	V
Maximum Output Current	1	$I_{OUT(MAX)}$	$V_{IN}=3.85V, V_{OUT(E)} \geq 2.565V$	150			mA
Minimum Load Current		$I_{OUT(MIN)}$	$V_{IN}=V_{OUT}+1V$			50	$\mu A$
Load Stability	1	$\Delta V_{OUT}$	$V_{IN}=3.85V$ $1mA \leq I_{OUT} \leq 77mA$		45	90	mV
Input-Output Voltage Differential(Note3)	1	$V_{DIF1}$	$I_{OUT}=77mA$		180	360	mV
	1	$V_{DIF2}$	$I_{OUT}=154mA$		400	700	mV
Supply Current	2	$I_{SS}$	$V_{IN}=3.85V$		2.0	4.5	$\mu A$
Input Stability	1	$\frac{\Delta V_{OUT}}{\Delta V_{IN} \times V_{OUT}}$	$I_{OUT}=40mA$ $3.85V \leq V_{IN} \leq 10V$		0.2	0.3	%/V
Input Voltage		$V_{IN}$	$I_{OUT}=5mA$			10	V
Thermal Shutdown					150		$^{\circ}C$
Output Voltage Temperature Characteristics	1	$\frac{\Delta V_{OUT}}{\Delta T_{OPR} \times V_{OUT}}$	$I_{OUT}=40mA$ $-40^{\circ}C \leq T_{OPR} \leq 85^{\circ}C$		$\pm 100$		ppm/ $^{\circ}C$

**UR6225-2.8V (Note1)**

PARAMETER	CIRCUIT	SYMBOL	TEST CONDITONS	MIN	TYP	MAX	UNIT
Output Voltage	1	$V_{OUT(E)}$ (Note2)	$I_{OUT}=50\mu A \sim 40mA, V_{IN}=3.8V$	2.744	2.800	2.856	V
Maximum Output Current	1	$I_{OUT(MAX)}$	$V_{IN}=3.8V, V_{OUT(E)} \geq 2.52V$	150			mA
Minimum Load Current		$I_{OUT(MIN)}$	$V_{IN}=V_{OUT}+1V$			50	$\mu A$
Load Stability	1	$\Delta V_{OUT}$	$V_{IN}=3.8V$ $1mA \leq I_{OUT} \leq 76mA$		45	90	mV
Input-Output Voltage Differential(Note3)	1	$V_{DIF1}$	$I_{OUT}=76mA$		180	360	mV
	1	$V_{DIF2}$	$I_{OUT}=152mA$		400	700	mV
Supply Current	2	$I_{SS}$	$V_{IN}=3.8V$		2.0	4.5	$\mu A$
Input Stability	1	$\frac{\Delta V_{OUT}}{\Delta V_{IN} \times V_{OUT}}$	$I_{OUT}=40mA$ $3.8V \leq V_{IN} \leq 10V$		0.2	0.3	%/V
Input Voltage		$V_{IN}$	$I_{OUT}=5mA$			10	V
Thermal Shutdown					150		$^{\circ}C$
Output Voltage Temperature Characteristics	1	$\frac{\Delta V_{OUT}}{\Delta T_{OPR} \times V_{OUT}}$	$I_{OUT}=40mA$ $-40^{\circ}C \leq T_{OPR} \leq 85^{\circ}C$		$\pm 100$		ppm/ $^{\circ}C$

■ ELECTRICAL CHARACTERISTICS(Cont.)

**UR6225-2.7V (Note1)**

PARAMETER	CIRCUIT	SYMBOL	TEST CONDITONS	MIN	TYP	MAX	UNIT
Output Voltage	1	V <sub>OUT(E)</sub> (Note2)	I <sub>OUT</sub> =50μA ~40mA, V <sub>IN</sub> =3.7V	2.646	2.700	2.754	V
Maximum Output Current	1	I <sub>OUT(MAX)</sub>	V <sub>IN</sub> =3.7V, V <sub>OUT(E)</sub> ≥2.43V	150			mA
Minimum Load Current		I <sub>OUT(MIN)</sub>	V <sub>IN</sub> =V <sub>OUT</sub> +1V			50	μA
Load Stability	1	ΔV <sub>OUT</sub>	V <sub>IN</sub> =3.7V 1mA≤I <sub>OUT</sub> ≤76mA		45	90	mV
Input-Output Voltage Differential(Note3)	1	V <sub>DIF1</sub>	I <sub>OUT</sub> =76mA		180	360	mV
	1	V <sub>DIF2</sub>	I <sub>OUT</sub> =152mA		400	700	mV
Supply Current	2	I <sub>SS</sub>	V <sub>IN</sub> =3.7V		2.0	4.5	μA
Input Stability	1	$\frac{\Delta V_{OUT}}{\Delta V_{IN} \times V_{OUT}}$	I <sub>OUT</sub> =40mA 3.7V≤V <sub>IN</sub> ≤10V		0.2	0.3	%/V
Input Voltage		V <sub>IN</sub>	I <sub>OUT</sub> =5mA			10	V
Thermal Shutdown					150		°C
Output Voltage Temperature Characteristics	1	$\frac{\Delta V_{OUT}}{\Delta T_{OPR} \times V_{OUT}}$	I <sub>OUT</sub> =40mA -40°C≤T <sub>OPR</sub> ≤85°C		±100		ppm/°C

**UR6225-2.6V (Note1)**

PARAMETER	CIRCUIT	SYMBOL	TEST CONDITONS	MIN	TYP	MAX	UNIT
Output Voltage	1	V <sub>OUT(E)</sub> (Note2)	I <sub>OUT</sub> =50μA ~40mA, V <sub>IN</sub> =3.6V	2.548	2.600	2.652	V
Maximum Output Current	1	I <sub>OUT(MAX)</sub>	V <sub>IN</sub> =3.6V, V <sub>OUT(E)</sub> ≥2.34V	150			mA
Minimum Load Current		I <sub>OUT(MIN)</sub>	V <sub>IN</sub> =V <sub>OUT</sub> +1V			50	μA
Load Stability	1	ΔV <sub>OUT</sub>	V <sub>IN</sub> =3.6V 1mA≤I <sub>OUT</sub> ≤72mA		45	90	mV
Input-Output Voltage Differential(Note3)	1	V <sub>DIF1</sub>	I <sub>OUT</sub> =72mA		180	360	mV
	1	V <sub>DIF2</sub>	I <sub>OUT</sub> =144mA		400	700	mV
Supply Current	2	I <sub>SS</sub>	V <sub>IN</sub> =3.6V		2.0	4.5	μA
Input Stability	1	$\frac{\Delta V_{OUT}}{\Delta V_{IN} \times V_{OUT}}$	I <sub>OUT</sub> =40mA 3.6V≤V <sub>IN</sub> ≤10V		0.2	0.3	%/V
Input Voltage		V <sub>IN</sub>	I <sub>OUT</sub> =5mA			10	V
Thermal Shutdown					150		°C
Output Voltage Temperature Characteristics	1	$\frac{\Delta V_{OUT}}{\Delta T_{OPR} \times V_{OUT}}$	I <sub>OUT</sub> =40mA -40°C≤T <sub>OPR</sub> ≤85°C		±100		ppm/°C

**UR6225-2.5V (Note1)**

PARAMETER	CIRCUIT	SYMBOL	TEST CONDITONS	MIN	TYP	MAX	UNIT
Output Voltage	1	V <sub>OUT(E)</sub> (Note2)	I <sub>OUT</sub> =50μA ~40mA, V <sub>IN</sub> =3.5V	2.45	2.500	2.55	V
Maximum Output Current	1	I <sub>OUT(MAX)</sub>	V <sub>IN</sub> =3.5V, V <sub>OUT(E)</sub> ≥2.25V	125			mA
Minimum Load Current		I <sub>OUT(MIN)</sub>	V <sub>IN</sub> =V <sub>OUT</sub> +1V			50	μA
Load Stability	1	ΔV <sub>OUT</sub>	V <sub>IN</sub> =3.5V 1mA≤I <sub>OUT</sub> ≤70mA		45	90	mV
Input-Output Voltage Differential(Note3)	1	V <sub>DIF1</sub>	I <sub>OUT</sub> =70mA		180	360	mV
	1	V <sub>DIF2</sub>	I <sub>OUT</sub> =140mA		400	700	mV
Supply Current	2	I <sub>SS</sub>	V <sub>IN</sub> =3.5V		2.0	4.5	μA
Input Stability	1	$\frac{\Delta V_{OUT}}{\Delta V_{IN} \times V_{OUT}}$	I <sub>OUT</sub> =40mA 3.5V≤V <sub>IN</sub> ≤10V		0.2	0.3	%/V
Input Voltage		V <sub>IN</sub>	I <sub>OUT</sub> =5mA			10	V
Thermal Shutdown					150		°C
Output Voltage Temperature Characteristics	1	$\frac{\Delta V_{OUT}}{\Delta T_{OPR} \times V_{OUT}}$	I <sub>OUT</sub> =40mA -40°C≤T <sub>OPR</sub> ≤85°C		±100		ppm/°C



■ ELECTRICAL CHARACTERISTICS(Cont.)

**UR6225-2.1V (Note1)**

PARAMETER	CIRCUIT	SYMBOL	TEST CONDITONS	MIN	TYP	MAX	UNIT
Output Voltage	1	$V_{OUT(E)}$ (Note2)	$I_{OUT}=50\mu A \sim 40mA$ , $V_{IN}=3.1V$	2.058	2.100	2.142	V
Maximum Output Current	1	$I_{OUT(MAX)}$	$V_{IN}=3.1V$ , $V_{OUT(E)} \geq 1.89V$	125			mA
Minimum Load Current		$I_{OUT(MIN)}$	$V_{IN}=V_{OUT}+1V$			50	$\mu A$
Load Stability	1	$\Delta V_{OUT}$	$V_{IN}=3.1V$ $1mA \leq I_{OUT} \leq 62mA$		45	90	mV
Input-Output Voltage Differential(Note3)	1	$V_{DIF1}$	$I_{OUT}=62mA$		180	360	mV
	1	$V_{DIF2}$	$I_{OUT}=124mA$		400	700	mV
Supply Current	2	$I_{SS}$	$V_{IN}=3.1V$		2.0	4.5	$\mu A$
Input Stability	1	$\frac{\Delta V_{OUT}}{\Delta V_{IN} \times V_{OUT}}$	$I_{OUT}=40mA$ $3.1V \leq V_{IN} \leq 10V$		0.2	0.3	%/V
Input Voltage		$V_{IN}$	$I_{OUT}=5mA$			10	V
Thermal Shutdown					150		$^{\circ}C$
Output Voltage Temperature Characteristics	1	$\frac{\Delta V_{OUT}}{\Delta T_{OPR} \times V_{OUT}}$	$I_{OUT}=40mA$ $-40^{\circ}C \leq T_{OPR} \leq 85^{\circ}C$		$\pm 100$		ppm/ $^{\circ}C$

**UR6225-2.0V (Note1)**

PARAMETER	CIRCUIT	SYMBOL	TEST CONDITONS	MIN	TYP	MAX	UNIT
Output Voltage	1	$V_{OUT(E)}$ (Note2)	$I_{OUT}=50\mu A \sim 40mA$ , $V_{IN}=3.0V$	1.960	2.000	2.040	V
Maximum Output Current	1	$I_{OUT(MAX)}$	$V_{IN}=3.0V$ , $V_{OUT(E)} \geq 1.8V$	100			mA
Minimum Load Current		$I_{OUT(MIN)}$	$V_{IN}=V_{OUT}+1V$			50	$\mu A$
Load Stability	1	$\Delta V_{OUT}$	$V_{IN}=3.0V$ $1mA \leq I_{OUT} \leq 60mA$		45	90	mV
Input-Output Voltage Differential(Note3)	1	$V_{DIF1}$	$I_{OUT}=60mA$		180	360	mV
	1	$V_{DIF2}$	$I_{OUT}=120mA$		400	700	mV
Supply Current	2	$I_{SS}$	$V_{IN}=3.0V$		2.0	4.5	$\mu A$
Input Stability	1	$\frac{\Delta V_{OUT}}{\Delta V_{IN} \times V_{OUT}}$	$I_{OUT}=40mA$ $3.0V \leq V_{IN} \leq 10V$		0.2	0.3	%/V
Input Voltage		$V_{IN}$	$I_{OUT}=5mA$			10	V
Thermal Shutdown					150		$^{\circ}C$
Output Voltage Temperature Characteristics	1	$\frac{\Delta V_{OUT}}{\Delta T_{OPR} \times V_{OUT}}$	$I_{OUT}=40mA$ $-40^{\circ}C \leq T_{OPR} \leq 85^{\circ}C$		$\pm 100$		ppm/ $^{\circ}C$

**UR6225-1.8V (Note1)**

PARAMETER	CIRCUIT	SYMBOL	TEST CONDITONS	MIN	TYP	MAX	UNIT
Output Voltage	1	$V_{OUT(E)}$ (Note2)	$I_{OUT}=50\mu A \sim 40mA$ , $V_{IN}=2.8V$	1.764	1.800	1.836	V
Maximum Output Current	1	$I_{OUT(MAX)}$	$V_{IN}=2.8V$ , $V_{OUT(E)} \geq 1.62V$	100			mA
Minimum Load Current		$I_{OUT(MIN)}$	$V_{IN}=V_{OUT}+1V$			50	$\mu A$
Load Stability	1	$\Delta V_{OUT}$	$V_{IN}=2.8V$ $1mA \leq I_{OUT} \leq 60mA$		45	90	mV
Input-Output Voltage Differential(Note3)	1	$V_{DIF1}$	$I_{OUT}=56mA$		180	360	mV
	1	$V_{DIF2}$	$I_{OUT}=112mA$		400	700	mV
Supply Current	2	$I_{SS}$	$V_{IN}=2.8V$		2.0	4.5	$\mu A$
Input Stability	1	$\frac{\Delta V_{OUT}}{\Delta V_{IN} \times V_{OUT}}$	$I_{OUT}=40mA$ $2.8V \leq V_{IN} \leq 10V$		0.2	0.3	%/V
Input Voltage		$V_{IN}$	$I_{OUT}=5mA$			10	V
Thermal Shutdown					150		$^{\circ}C$
Output Voltage Temperature Characteristics	1	$\frac{\Delta V_{OUT}}{\Delta T_{OPR} \times V_{OUT}}$	$I_{OUT}=40mA$ $-40^{\circ}C \leq T_{OPR} \leq 85^{\circ}C$		$\pm 100$		ppm/ $^{\circ}C$

■ ELECTRICAL CHARACTERISTICS(Cont.)

**UR6225-1.5V (Note1)**

PARAMETER	CIRCUIT	SYMBOL	TEST CONDITONS	MIN	TYP	MAX	UNIT
Output Voltage	1	$V_{OUT}(E)$ (Note2)	$I_{OUT}=50\mu A \sim 40mA, V_{IN}=2.5V$	1.470	1.500	1.530	V
Maximum Output Current	1	$I_{OUT(MAX)}$	$V_{IN}=2.5V, V_{OUT}(E) \geq 1.35V$	100			mA
Minimum Load Current		$I_{OUT(MIN)}$	$V_{IN}=V_{OUT}+1V$			50	$\mu A$
Load Stability	1	$\Delta V_{OUT}$	$V_{IN}=2.5V$ $1mA \leq I_{OUT} \leq 60mA$		45	90	mV
Input-Output Voltage Differential(Note3)	1	$V_{DIF1}$	$I_{OUT}=56mA$		180	360	mV
	1	$V_{DIF2}$	$I_{OUT}=112mA$		400	700	mV
Supply Current	2	$I_{SS}$	$V_{IN}=2.5V$		2.0	4.5	$\mu A$
Input Stability	1	$\frac{\Delta V_{OUT}}{\Delta V_{IN} \times V_{OUT}}$	$I_{OUT}=40mA$ $2.5V \leq V_{IN} \leq 10V$		0.2	0.3	%/V
Input Voltage		$V_{IN}$	$I_{OUT}=5mA$			10	V
Thermal Shutdown					150		$^{\circ}C$
Output Voltage Temperature Characteristics	1	$\frac{\Delta V_{OUT}}{\Delta T_{OPR} \times V_{OUT}}$	$I_{OUT}=40mA$ $-40^{\circ}C \leq T_{OPR} \leq 85^{\circ}C$		$\pm 100$		ppm/ $^{\circ}C$

**UR6225-1.3V (Note1)**

PARAMETER	CIRCUIT	SYMBOL	TEST CONDITONS	MIN	TYP	MAX	UNIT
Output Voltage	1	$V_{OUT}(E)$ (Note2)	$I_{OUT}=50\mu A \sim 40mA, V_{IN}=2.3V$	1.274	1.300	1.326	V
Maximum Output Current	1	$I_{OUT(MAX)}$	$V_{IN}=2.3V, V_{OUT}(E) \geq 1.17V$	100			mA
Minimum Load Current		$I_{OUT(MIN)}$	$V_{IN}=V_{OUT}+1V$			50	$\mu A$
Load Stability	1	$\Delta V_{OUT}$	$V_{IN}=2.3V$ $1mA \leq I_{OUT} \leq 60mA$		45	90	mV
Input-Output Voltage Differential(Note3)	1	$V_{DIF1}$	$I_{OUT}=56mA$		180	360	mV
	1	$V_{DIF2}$	$I_{OUT}=112mA$		400	700	mV
Supply Current	2	$I_{SS}$	$V_{IN}=2.3V$		2.0	4.5	$\mu A$
Input Stability	1	$\frac{\Delta V_{OUT}}{\Delta V_{IN} \times V_{OUT}}$	$I_{OUT}=40mA$ $2.3V \leq V_{IN} \leq 10V$		0.2	0.3	%/V
Input Voltage		$V_{IN}$	$I_{OUT}=5mA$			10	V
Thermal Shutdown					150		$^{\circ}C$
Output Voltage Temperature Characteristics	1	$\frac{\Delta V_{OUT}}{\Delta T_{OPR} \times V_{OUT}}$	$I_{OUT}=40mA$ $-40^{\circ}C \leq T_{OPR} \leq 85^{\circ}C$		$\pm 100$		ppm/ $^{\circ}C$

**UR6225-1.2V (Note1)**

PARAMETER	CIRCUIT	SYMBOL	TEST CONDITONS	MIN	TYP	MAX	UNIT
Output Voltage	1	$V_{OUT}(E)$ (Note2)	$I_{OUT}=50\mu A \sim 40mA, V_{IN}=2.2V$	1.176	1.200	1.224	V
Maximum Output Current	1	$I_{OUT(MAX)}$	$V_{IN}=2.2V, V_{OUT}(E) \geq 1.08V$	100			mA
Minimum Load Current		$I_{OUT(MIN)}$	$V_{IN}=V_{OUT}+1V$			50	$\mu A$
Load Stability	1	$\Delta V_{OUT}$	$V_{IN}=2.2V$ $1mA \leq I_{OUT} \leq 60mA$		45	90	mV
Input-Output Voltage Differential(Note3)	1	$V_{DIF1}$	$I_{OUT}=56mA$		180	360	mV
	1	$V_{DIF2}$	$I_{OUT}=112mA$		400	700	mV
Supply Current	2	$I_{SS}$	$V_{IN}=2.2V$		2.0	4.5	$\mu A$
Input Stability	1	$\frac{\Delta V_{OUT}}{\Delta V_{IN} \times V_{OUT}}$	$I_{OUT}=40mA$ $2.2V \leq V_{IN} \leq 10V$		0.2	0.3	%/V
Input Voltage		$V_{IN}$	$I_{OUT}=5mA$			10	V
Thermal Shutdown					150		$^{\circ}C$
Output Voltage Temperature Characteristics	1	$\frac{\Delta V_{OUT}}{\Delta T_{OPR} \times V_{OUT}}$	$I_{OUT}=40mA$ $-40^{\circ}C \leq T_{OPR} \leq 85^{\circ}C$		$\pm 100$		ppm/ $^{\circ}C$

Note: 1.  $V_{OUT}(T)$ =Specified Output Voltage.

2.  $V_{OUT}(E)$ =Effective Output Voltage (i.e. the output voltage when " $V_{OUT}(T)+1.0V$ " is provided at the  $V_{IN}$  pin while maintaining a certain  $I_{OUT}$  value).

3.  $V_{DIF} = \{V_{IN1}^{(Note4)} - V_{OUT}(E)\}$

4.  $V_{IN1}$ = The input voltage at the time 98% of  $V_{OUT}(E)$  is output (input voltage has been gradually reduced).

## ■ TEST CIRCUITS

Circuit 1

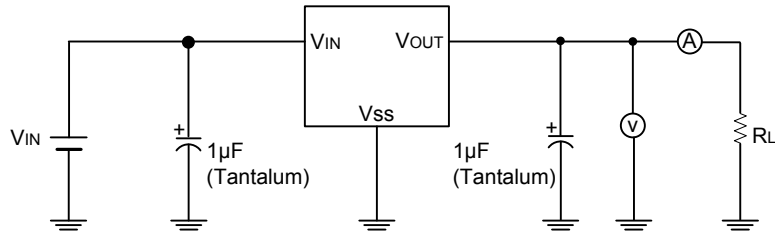

Circuit 2

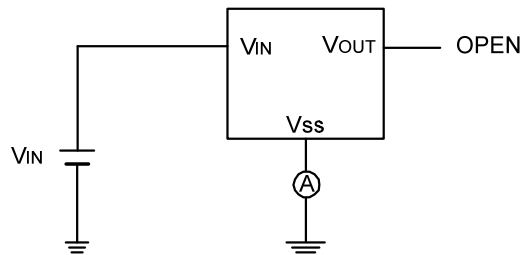

## ■ TYPICAL APPLICATION CIRCUIT

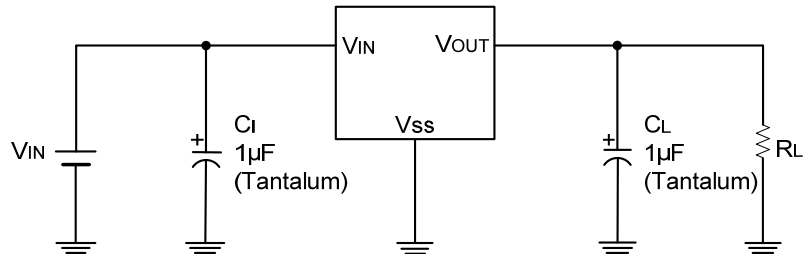

## ■ TYPICAL CHARACTERISTIC

### (1) OUTPUT VOLTAGE VS. OUTPUT CURRENT

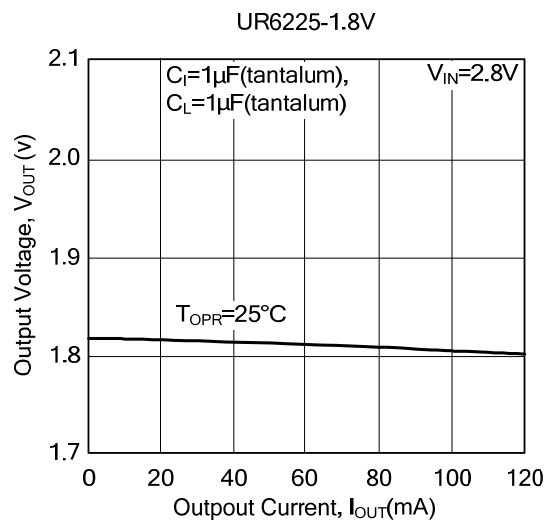
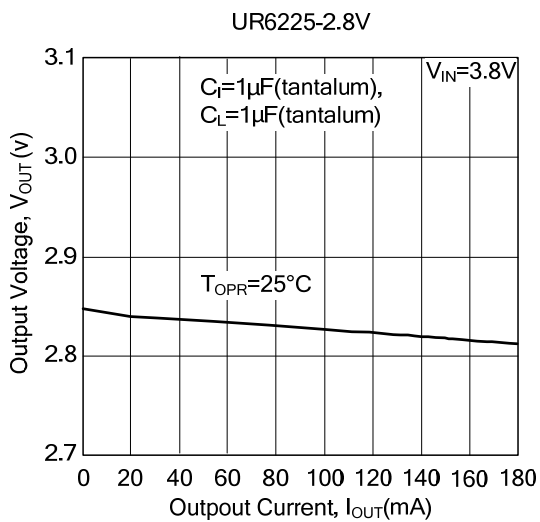
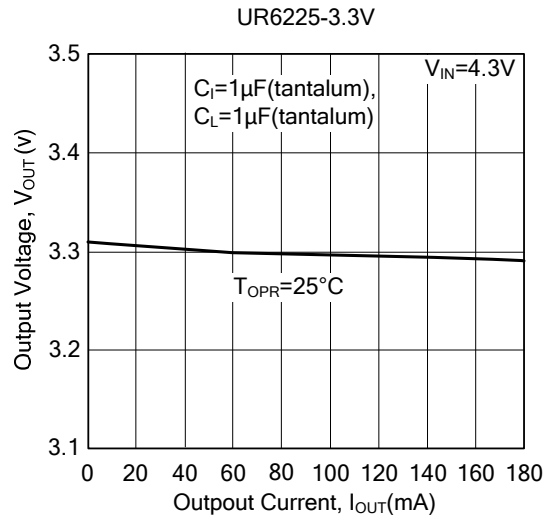
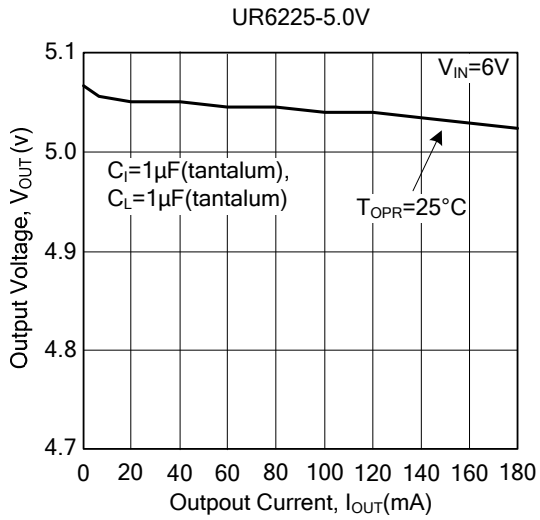

### (2) OUTPUT VOLTAGE VS. INPUT VOLTAGE

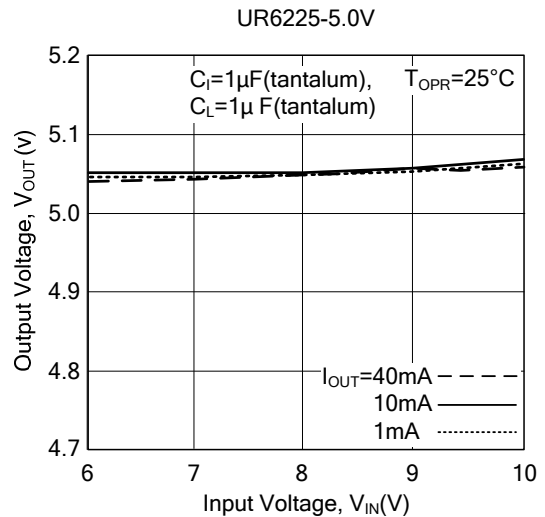
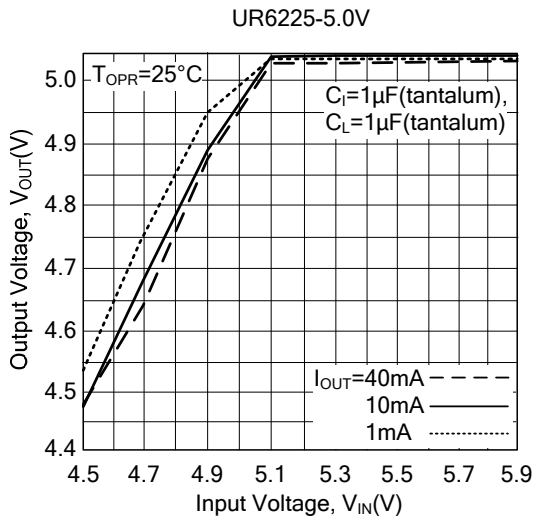

■ TYPICAL CHARACTERISTIC(Cont.)

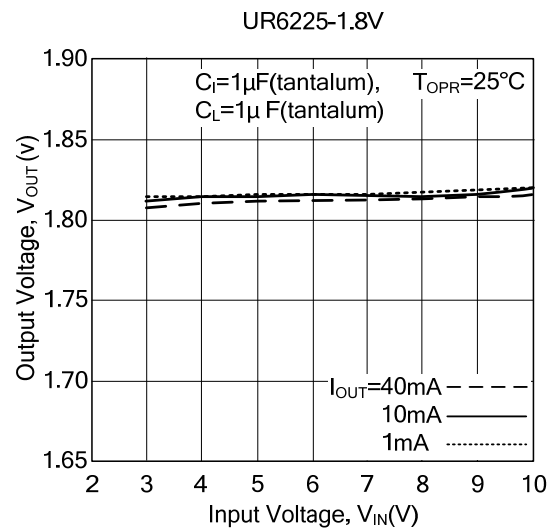
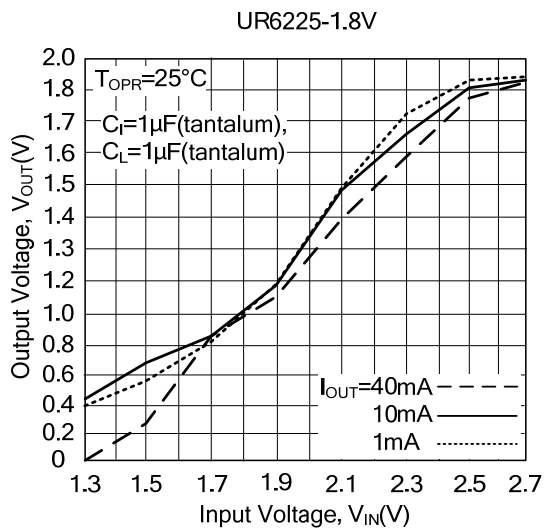
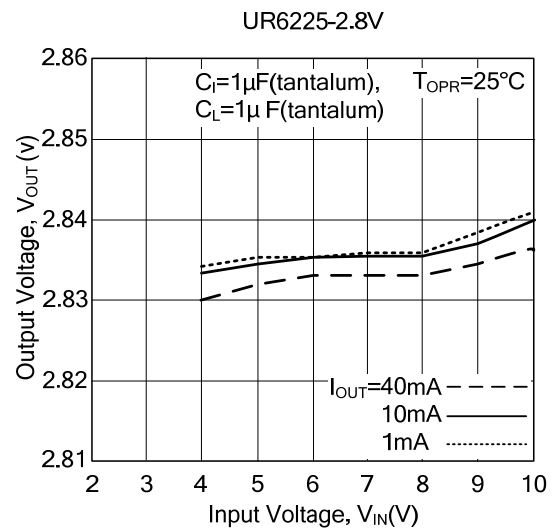
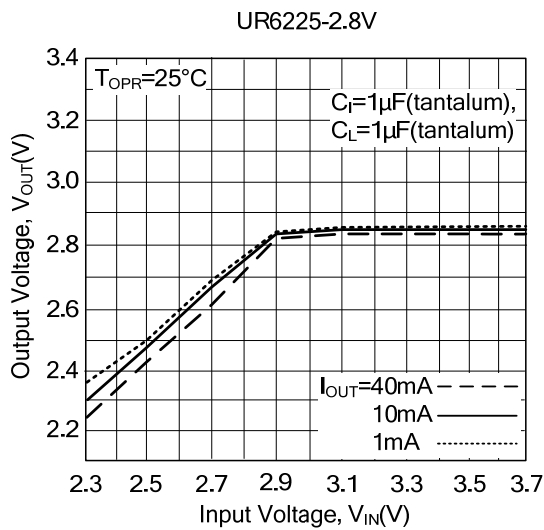
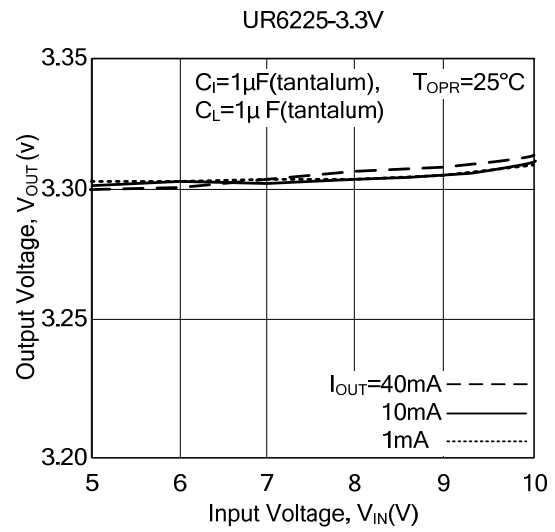
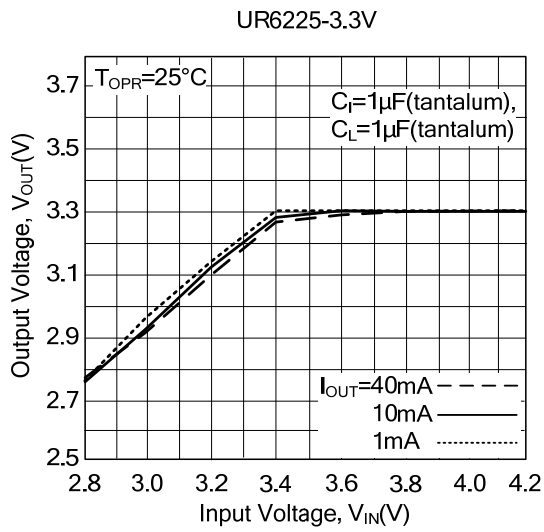

■ TYPICAL CHARACTERISTIC(Cont.)

(3) INPUT/OUTPUT VOLTAGE DIFFERENTIAL VS. OUTPUT CURRENT

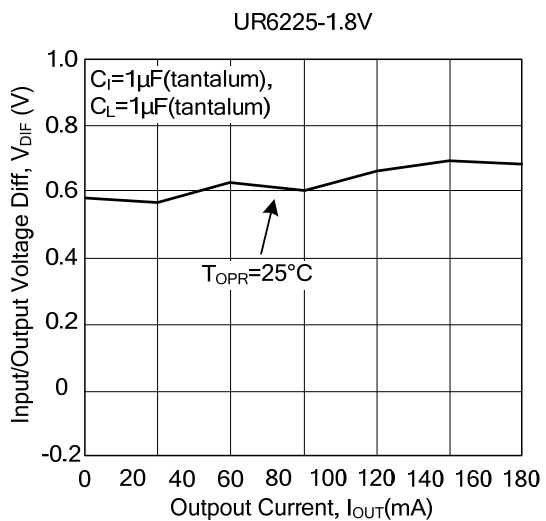
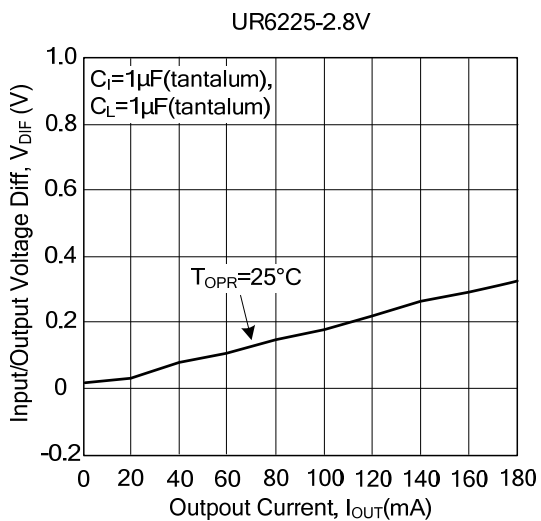
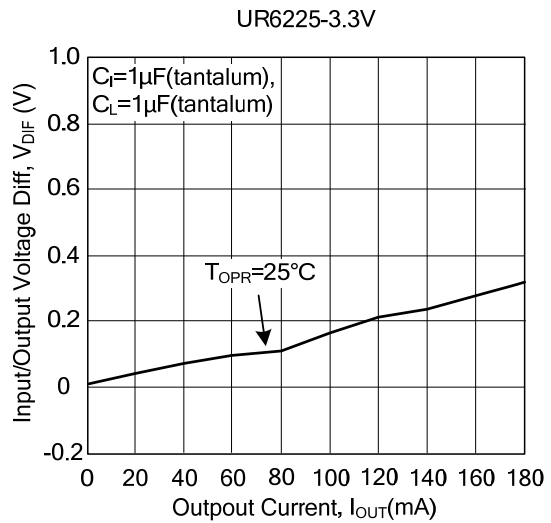
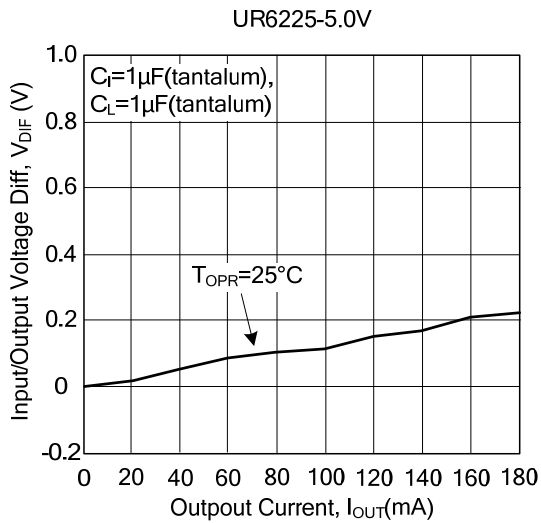

(4) SUPPLY CURRENT VS. INPUT VOLTAGE

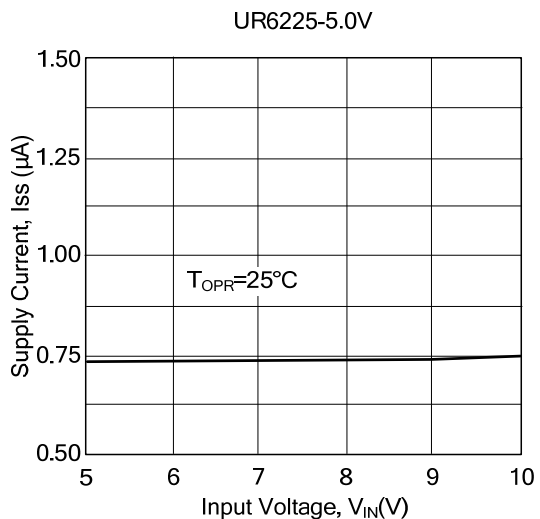
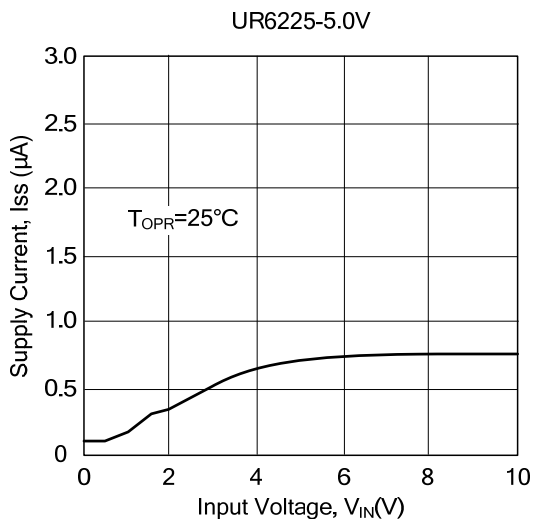

■ TYPICAL CHARACTERISTIC(Cont.)

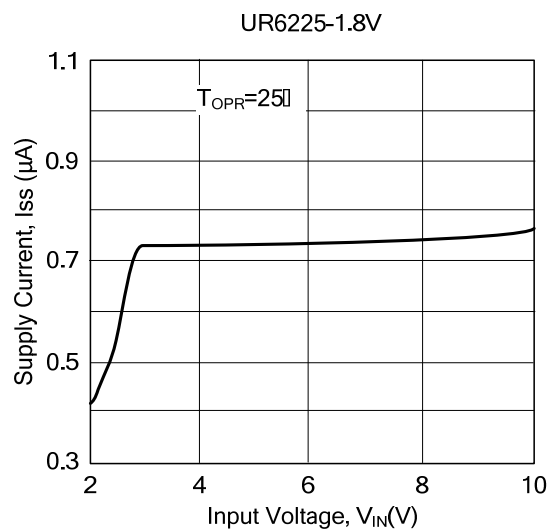
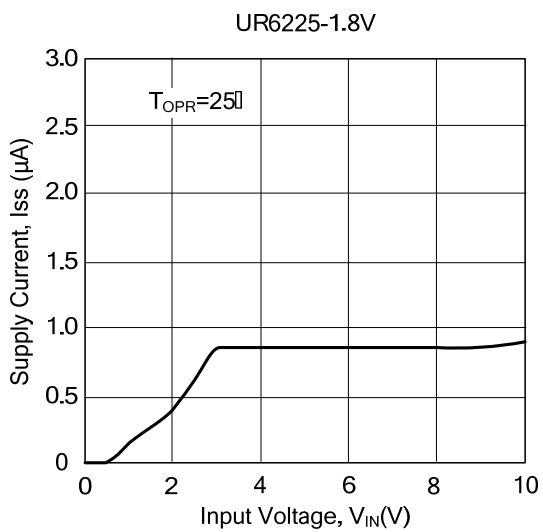
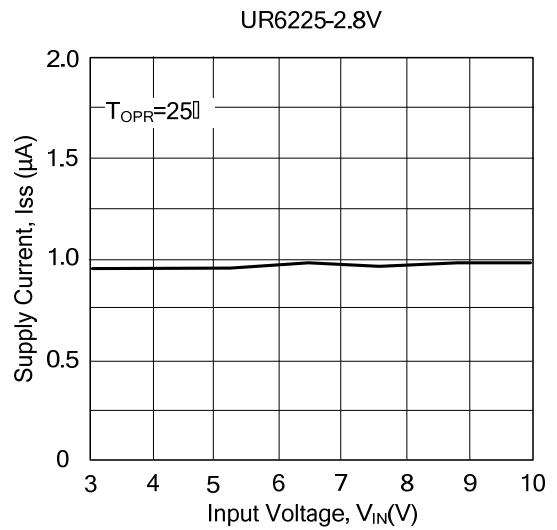
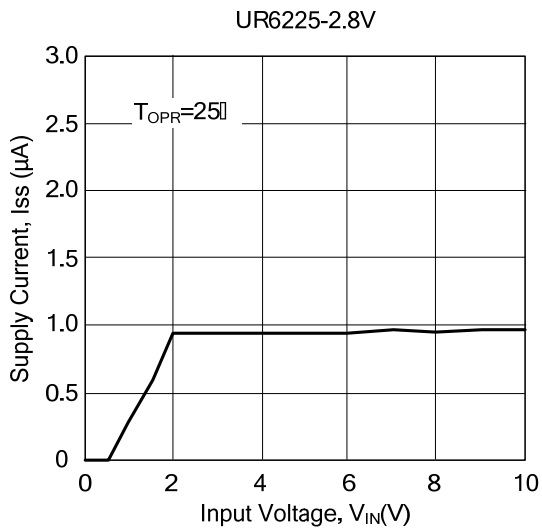
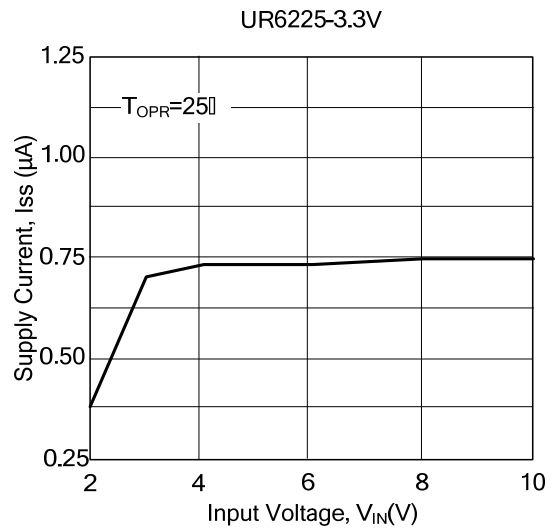
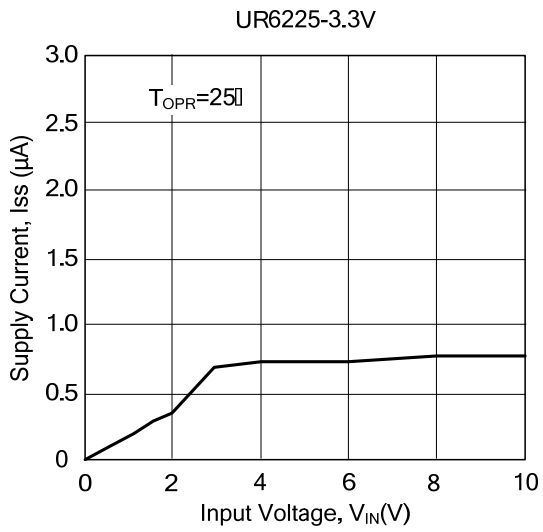

■ TYPICAL CHARACTERISTIC(Cont.)

(5) LOAD TRANSIENT RESPONSE

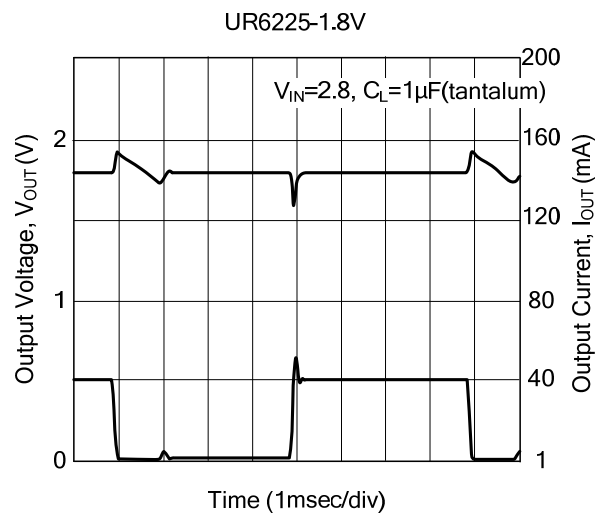
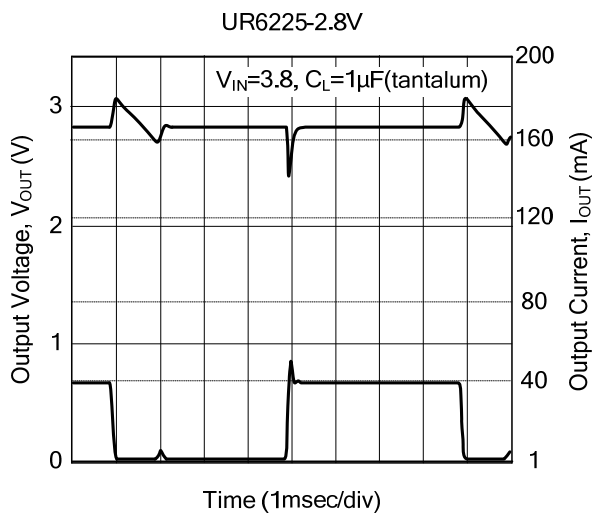
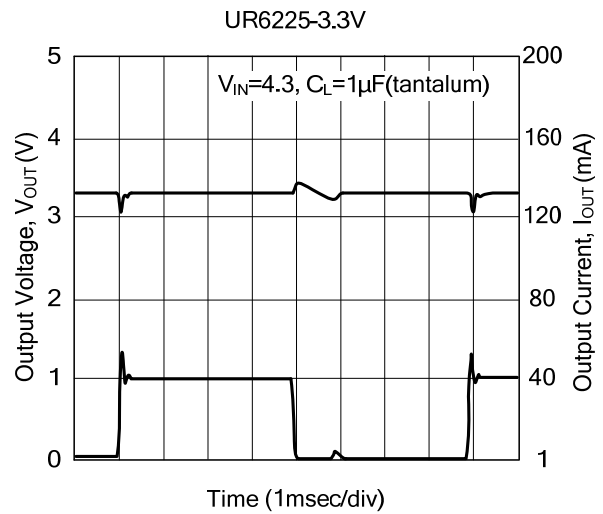
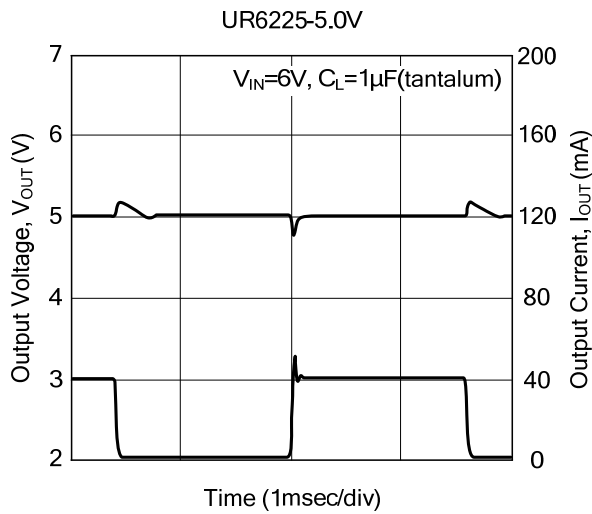

UTC assumes no responsibility for equipment failures that result from using products at values that exceed, even momentarily, rated values (such as maximum ratings, operating condition ranges, or other parameters) listed in products specifications of any and all UTC products described or contained herein. UTC products are not designed for use in life support appliances, devices or systems where malfunction of these products can be reasonably expected to result in personal injury. Reproduction in whole or in part is prohibited without the prior written consent of the copyright owner. The information presented in this document does not form part of any quotation or contract, is believed to be accurate and reliable and may be changed without notice.