

Customer Information Sheet

DRAWING No.: P20-XX13 SHEET 2 OF 2 IF IN DOUBT - ASK © NOT TO SCALE THIRD ANGLE PROJECTION ALL DIMENSIONS IN mm

PROBE HEAD VARIANTS

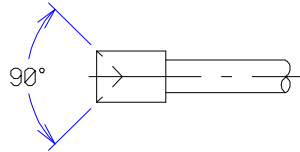

HARWIN PART NO.
P20-1013

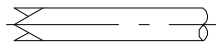

HARWIN PART NO.
P20-3013

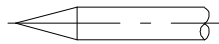

HARWIN PART NO.
P20-0113

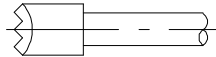

HARWIN PART NO.
P20-4013

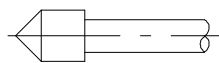

HARWIN PART NO.
P20-2013

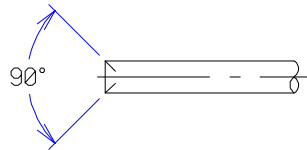

HARWIN PART NO.
P20-1313

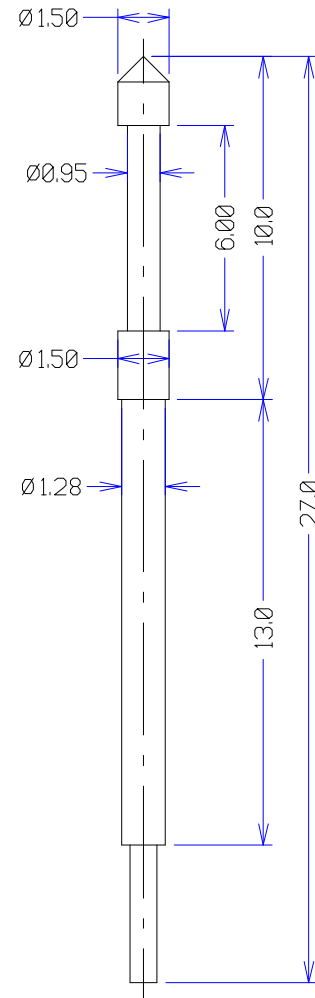

- NOTES:
1. MINIMUM CENTRES = 2.00mm.
 2. MATERIALS AND FINISH:
PLUNGER = BERYLLIUM COPPER,
GOLD PLATED
BARREL = NICKEL PLATED
 3. RECOMMENDED MOUNTING HOLE = Ø1.35-1.30mm.

SPECIFICATIONS:
FULL TRAVEL = 6.00mm
SPRING FORCE = 0.98N (100g) @ 6.00mm
CURRENT RATING = 3A

ORDER CODE:
P20-XX13
PROBE HEAD ———
VARIANT (SEE TABLE)

2	04.01.99	4703
ISS.	DATE	C/N
APPROVED:		
CHECKED:		
DRAWN: D. BECK		
CUSTOMER REF.		
ASSEMBLY DRG:		



TOLERANCES
X. = ±1mm
X.X = ±0.25mm
X.XX = ±0.10mm
X.XXX = ±0.01mm
ANGLES = ±1°
UNLESS STATED

MATERIAL:
SEE NOTE 2

TITLE:
2.00mm MIN. CENTRE
ONE-PIECE SPRING PROBE

HARWIN INC
U.S.A.
TEL: (812) 285 0055
FAX: (812) 285 0056

HARWIN PLC
U.K.
TEL: 01705 370451
FAX: 01705 314590

HARWIN PTE
SINGAPORE
TEL: 65 7794909
FAX: 65 7793868

FINISH: SEE NOTE 2

DRAWING NUMBER:
P20-XX13

S/AREA: mm²

SHT
2
OF
2