

Spezifikation für Freigabe / specification for release

Kunde / customer :
 Artikelnummer / part number : **74479787215**
 Bezeichnung : **SMD-Powerinduktivität WE-PMI**
 description : **SMD-power inductance WE-PMI**



DATUM / DATE : 2010-11-08

A Mechanische Abmessungen / dimensions:

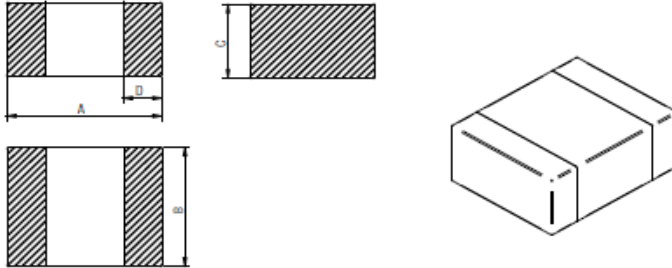

Größe / size 1008		
A	2,5 ± 0,2	mm
B	2,0 ± 0,2	mm
C	1,0 ± 0,2	mm
D	0,5 ± 0,2	mm

B Elektrische Eigenschaften / electrical properties:

Eigenschaften / properties	Testbedingungen / test conditions		Wert / value	Einheit / unit	tol.
Induktivität / inductance	1 MHz	L	1,5	μH	±20%
Güte Q / Q factor	1 MHz	Q	15		min.
DC-Widerstand / DC-resistance	@ 20°C	R _{DC}	70	mΩ	±30%
Eigenres.-Frequenz / self-res.-frequency		SRF	70	MHz	min.
Nennstrom / rated current	ΔT=20 K	I _{DC}	1200	mA	typ.
Nennstrom / rated current	ΔT=40 K	I _{DC}	1600	mA	typ.
Sättigungsstrom / saturation current	 ΔL/L <30%	I _{sat}	800	mA	typ.

C Lötpad / soldering spec.:

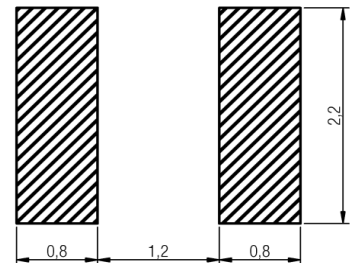

D Prüfgeräte / test equipment:

Agilent E4991 A für/for L und/and Q und/and SRF
GMC Metrahit 27i für/for R_{DC}
WK3260B für/for I_{sat}
Agilent 6032 für/for I_{DC}

E Testbedingungen / test conditions:

Luftfeuchtigkeit / humidity: 33%
 Umgebungstemperatur / temperature: +20 °C

F Werkstoffe & Zulassungen / material & approvals:

Basismaterial / base material: Ferrit / ferrite

G Eigenschaften / general specifications:

Betriebstemp. / operating temperature: -40 °C - + 125 °C
 Umgebungstemp. / ambient temperature: -40 °C - + 85 °C
 It is recommended that the temperature of the part does not exceed 125 °C under worst case operating conditions.

Freigabe erteilt / general release:	Kunde / customer		
	
Datum / date	Würth Elektronik		
.....		
Geprüft / checked	Würth Elektronik	Ddi	Version 2
.....	Ddi	Version 1
Geprüft / checked	Würth Elektronik	Name	Änderung / modification
.....		Datum / date

Würth Elektronik eiSos GmbH & Co. KG

D-74638 Waldenburg · Max-Eyth-Strasse 1 - 3 · Germany · Telefon (+49) (0) 7942 - 945 - 0 · Telefax (+49) (0) 7942 - 945 - 400
<http://www.we-online.com>

Spezifikation für Freigabe / specification for release

Kunde / customer :
 Artikelnummer / part number : **74479787215**
 Bezeichnung : **SMD-Powerinduktivität WE-PMI**
 description : **SMD-power inductance WE-PMI**



DATUM / DATE : 2010-11-08

H Induktivitätskurve / Inductance curve :

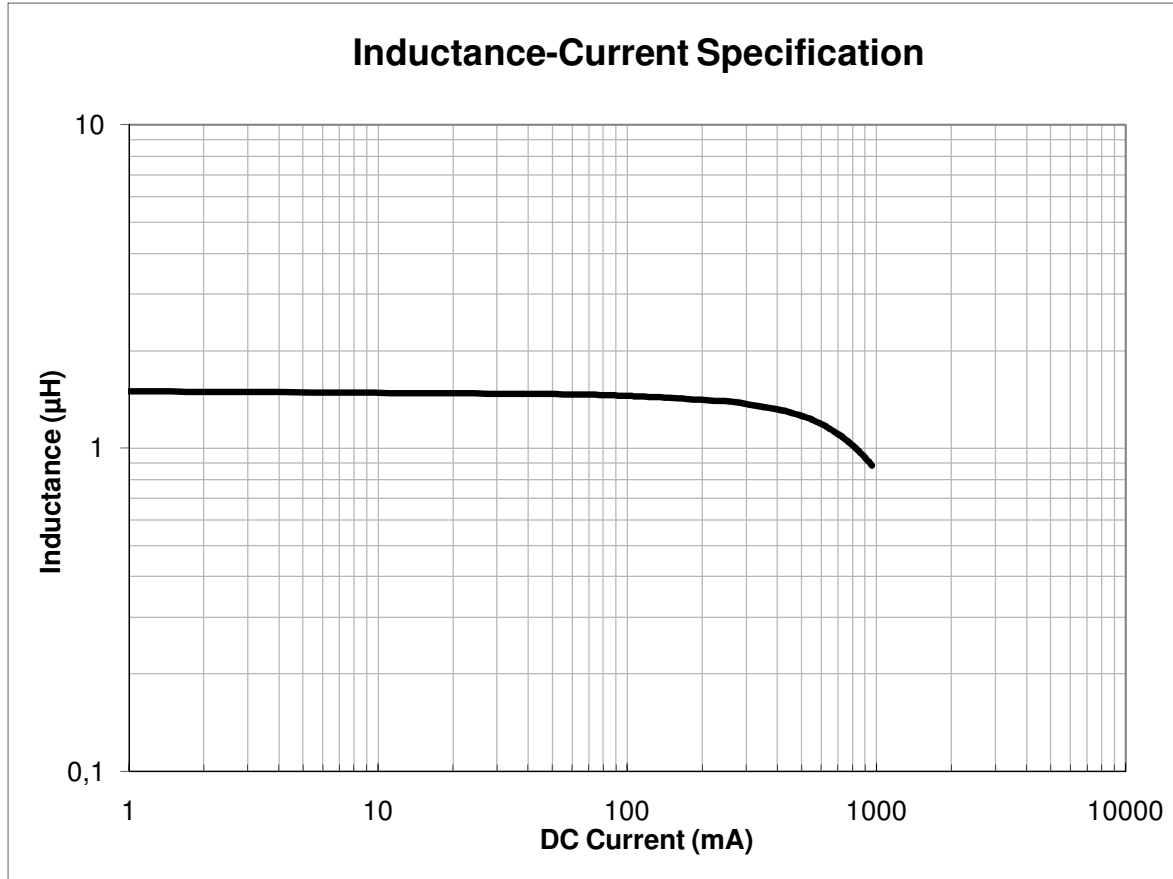

Freigabe erteilt / general release:	Kunde / customer			
.....			
Datum / date	Unterschrift / signature			
	Würth Elektronik			
.....	Ddi	Version 2	11-05-24
Geprüft / checked	Kontrolliert / approved	Ddi	Version 1	10-11-08
		Name	Änderung / modification	Datum / date

Würth Elektronik eiSos GmbH & Co. KG

D-74638 Waldenburg · Max-Eyth-Strasse 1 - 3 · Germany · Telefon (+49) (0) 7942 - 945 - 0 · Telefax (+49) (0) 7942 - 945 - 400
<http://www.we-online.com>

Spezifikation für Freigabe / specification for release

Kunde / customer :
 Artikelnummer / part number : **74479787215**
 Bezeichnung : **SMD-Powerinduktivität WE-PMI**
 description : **SMD-power inductance WE-PMI**



DATUM / DATE : 2010-11-08

I Induktivitätskurve / Inductance curve :

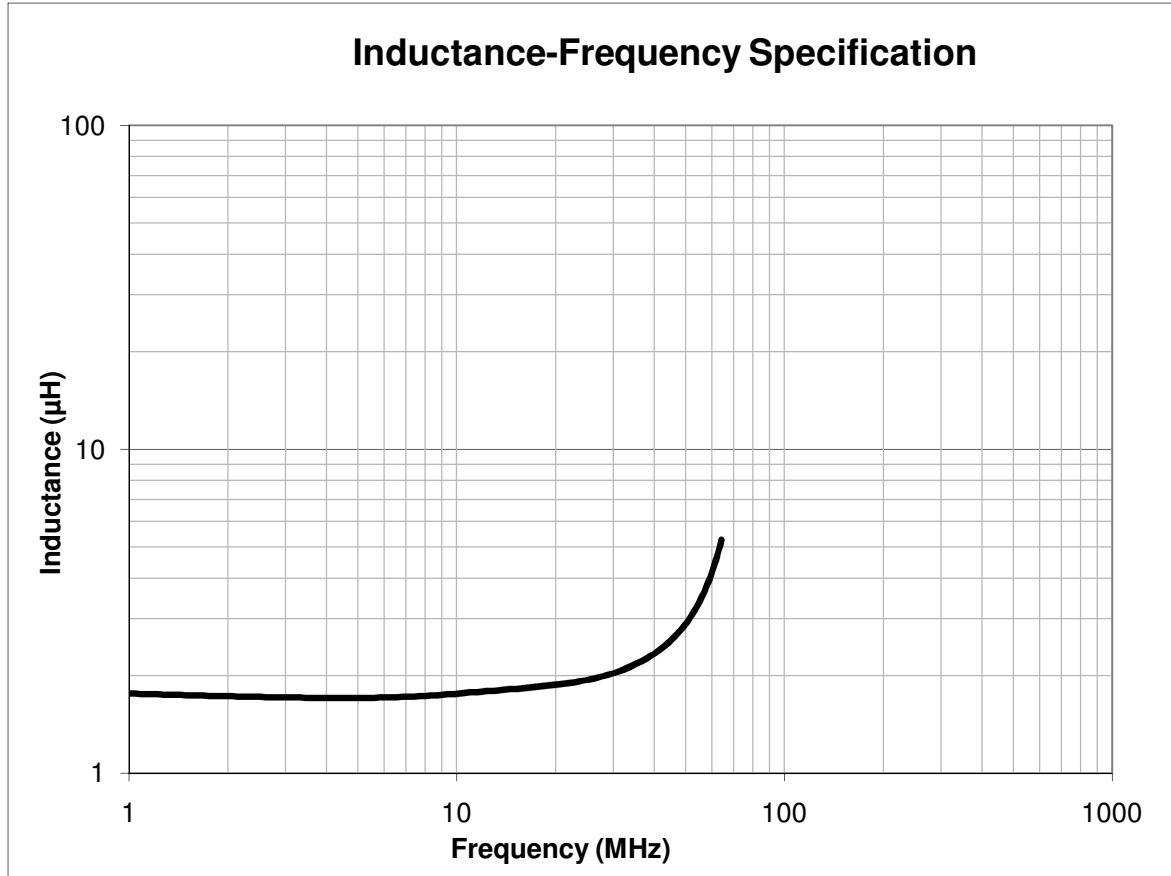

Freigabe erteilt / general release:	Kunde / customer			
.....			
Datum / date	Unterschrift / signature			
	Würth Elektronik			
.....	Ddi	Version 2	11-05-24
Geprüft / checked	Kontrolliert / approved	Ddi	Version 1	10-11-08
		Name	Änderung / modification	Datum / date

Würth Elektronik eiSos GmbH & Co. KG

D-74638 Waldenburg · Max-Eyth-Strasse 1 - 3 · Germany · Telefon (+49) (0) 7942 - 945 - 0 · Telefax (+49) (0) 7942 - 945 - 400
<http://www.we-online.com>

Spezifikation für Freigabe / specification for release

Kunde / customer :
 Artikelnummer / part number : **74479787215**
 Bezeichnung : **SMD-Powerinduktivität WE-PMI**
 description : **SMD-power inductance WE-PMI**



DATUM / DATE : 2010-11-08

J Rollenspezifikation / Tape & Reel specification :

Tape Spezifikation / tape specification

Material / Material: Polystyrene / polystyrene
 Abmessungen in / dimensions in mm / mm

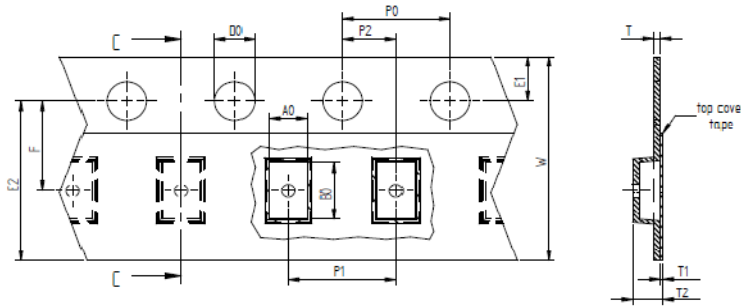

	A0	B0	W	P1	T	T1	T2	D0	E1	E2	F	P0	P2	VPE / packaging unit	
tolerance	typ.	typ.	+0,3 -0,1	± 0,1	± 0,1	max.	typ.	+0,1 -0,0	± 0,1	min.	± 0,05	± 0,1	± 0,05		
size	1008	2,50	3,00	8,00	4,00	0,25	0,10	1,42	1,50	1,75	6,25	3,50	4,00	2,00	3000

Reel Spezifikation / reel specification

Material / Material: Kunststoff / Plastic
 Abmessungen in / dimensions in mm / mm

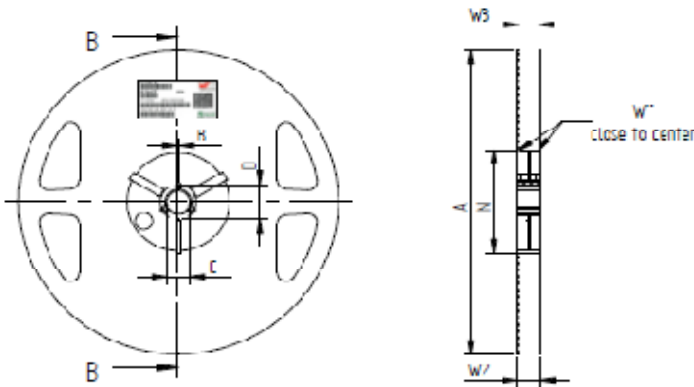

Maß / size	Bandbreite 8 mm / Tape width 8 mm	
A	178	
B	1,5	min.
C	13,0	± 0,8
D	20,2	min.
N	50	min.
W1	8,4	± 1,5
W2	14,4	max.
W3	7,9	min.
W3	10,9	max.

Freigabe erteilt / general release:	Kunde / customer		
		
Datum / date	Unterschrift / signature		
	Würth Elektronik		
		
Geprüft / checked	Kontrolliert / approved		
	Ddi	Version 2	08-01-02
	Ddi	Version 1	07-11-08
	Name	Änderung / modification	Datum / date

This electronic component has been designed and developed for usage in general electronic equipment. Before incorporating this component into any equipment where higher safety and reliability is especially required or if there is the possibility of direct damage or injury to human body, for example in the range of aerospace, aviation, nuclear control, submarine, transportation, (automotive control, train control, ship control), transportation signal, disaster prevention, medical, public information network etc, Würth Elektronik eiSos GmbH must be informed before the design-in stage. In addition, sufficient reliability evaluation checks for safety must be performed on every electronic component which is used in electrical circuits that require high safety and reliability functions or performance.

Würth Elektronik eiSos GmbH & Co. KG

D-74638 Waldenburg · Max-Eyth-Strasse 1 - 3 · Germany · Telefon (+49) (0) 7942 - 945 - 0 · Telefax (+49) (0) 7942 - 945 - 400