

INDUSTRIAL GRADE 5.0 x 3.2 x 1.1mm GLASS SEALED 2 PADS SMD CRYSTAL



5.0 X 3.2 X 1.1mm

ABH3

Preliminary. Contact
Abracon for availability

Pb in glass (exempt per
RoHS 2002/95/EC Annex (5))

RoHS
Compliant

FEATURES:

- Automotive standard AEC-Q200 compliant.
- Ceramic package hermetically glass sealed assures high precision and reliability.
- IR-reflow capable
- Tight tolerance and stability available.

APPLICATIONS:

- Automotive applications
- Industrial applications

STANDARD SPECIFICATIONS:

PARAMETERS	
ABRACON P/N	ABH3A Series
Frequency	8.000 MHz to 40.000 MHz
Operation Mode	AT cut fundamental
Operating Temperature	- 10°C to + 60°C (see options)
Storage Temperature	- 40°C to + 125°C
Frequency Tolerance	± 50 ppm max. (see options)
Frequency Stability over the Operating Temperature (Ref to + 25°C)	± 50 ppm max. (see options)
Equivalent Series Resistance	See table 1
Shunt Capacitance C0	5.0 pF max.
Load Capacitance CL	10 pF (see options)
Drive Level	100 µW max., 10 µW typical
Aging (First Year) @ 25°C ± 3°C	± 5ppm max.
Insulation Resistance	500 MΩ min at 100Vdc ± 15 Vdc

Table 1

Frequency (MHz)	ESR (Ω) max.
8.000-9.999	300
10.000 - 15.999	60
16.000 - 40.000	50

OPTIONS AND PART IDENTIFICATION: (Left blank if standard)

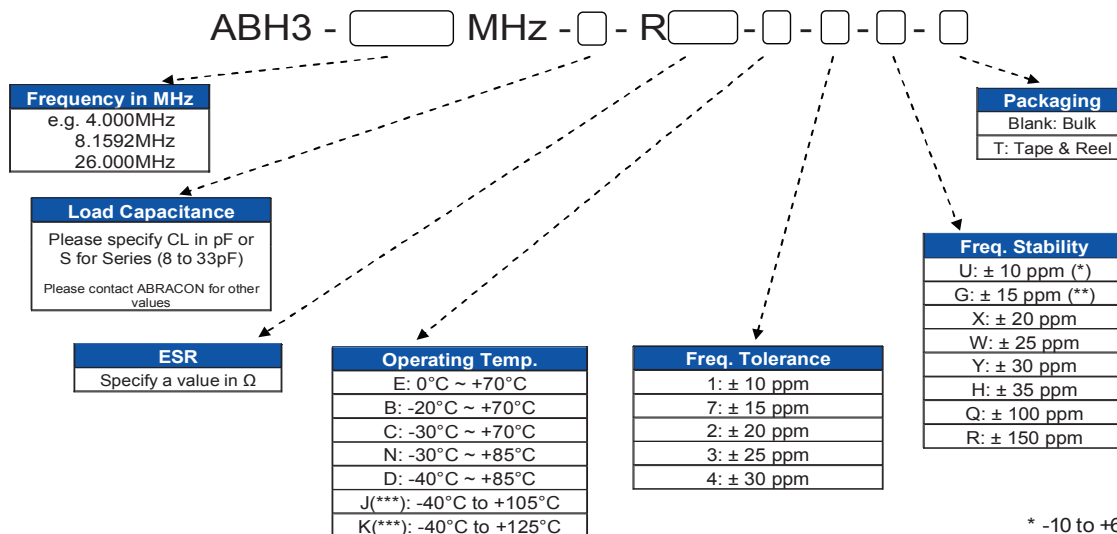

* -10 to +60Only.

** Option E, B, and -10 to +60Only.

*** Frequency stability ±100ppm, or ±150ppm only.
Contact ABRACON for tighter frequency stability.

ABRACON IS
ISO9001:2008
CERTIFIED



ABRACON
CORPORATION

Visit www.abracon.com for Terms & Conditions of Sale **Revised: 02.15.10**
30332 Esperanza, Rancho Santa Margarita, California 92688
tel 949-546-8000 | fax 949-546-8001 | www.abracon.com

INDUSTRIAL GRADE 5.0 x 3.2 x 1.1mm GLASS SEALED 2 PADS SMD CRYSTAL



ABH3

5.0 X 3.2 X 1.1mm

ABH3

Preliminary. Contact
Abracon for availability

Pb in glass (exempt per
RoHS 2002/95/EC Annex (5))

RoHS
Compliant

OUTLINE DRAWING:

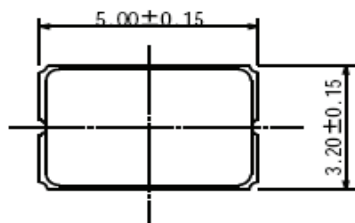

TOP View

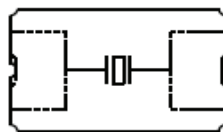

Example of a Terminal Land Pattern

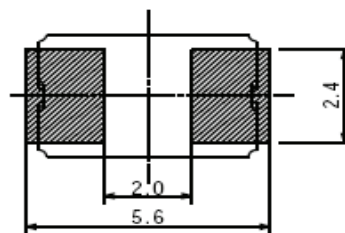
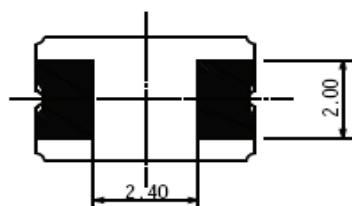

Dimensions: inch (mm)

TAPE & REEL: T=Tape and reel (1,000pcs/reel)

REFLOW PROFILE:

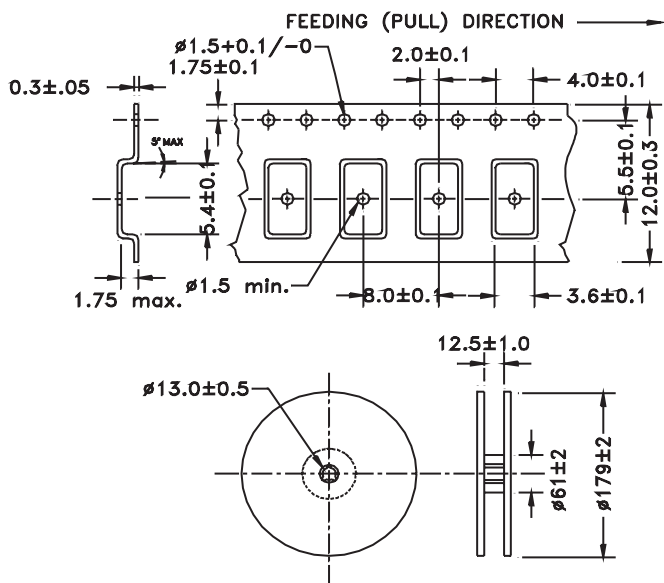

Dimensions: mm

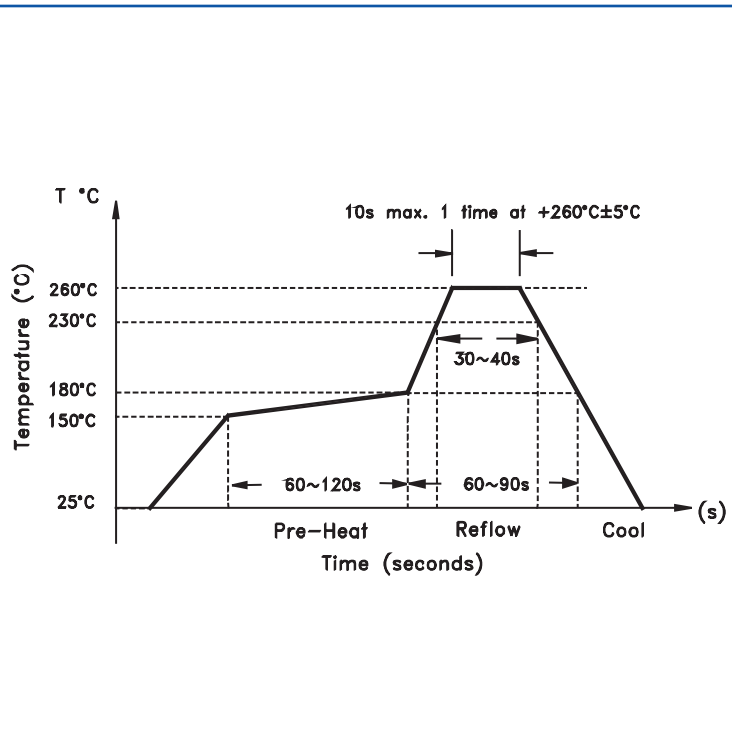

Need a test socket for the ABH3 Series? To view compatible **PRECISION TEST & BURN-IN SOCKETS** for these parts, [click here](#). P/N AXS-5032-02-06

NOTE: Abracon manufactured products are intended for general commercial and industrial use. For applications requiring high reliability and/or presenting extreme operating environment, written consent & authorization from Abracon is required.

ABRACON IS
ISO9001:2008
CERTIFIED



Visit www.abracon.com for Terms & Conditions of Sale **Revised: 02.15.10**
30332 Esperanza, Rancho Santa Margarita, California 92688
tel 949-546-8000 | fax 949-546-8001 | www.abracon.com