

GSC2176

600mA CMOS Positive Voltage Regulator

Description

The GSC2176 of positive, linear regulators feature low ground current (30µA typ.) with low dropout voltage, making them ideal for battery applications. The space-saving SOP-8 package is attractive for "Pocket" and "Hand Held" applications.

These rugged devices have both Thermal Shutdown, and Current Fold-back to prevent device failure under the "Worst" of operating conditions.

The GSC2176 is stable with an output capacitance of 2.2µF or greater.

Features

- Very Low Dropout Voltage
- Guaranteed 600mA output
- Accurate to within 1.5%
- Over-Temperature Shutdown
- Current Limiting
- Short Circuit Current Fold-back
- Low Temperature Coefficient
- Power-saving Shutdown Mode
- User Adjustable Output Voltages

Applications

- Battery Powered Widgets
- Instrumentation
- Wireless Devices
- Cordless Phones
- PC Peripherals
- Portable Electronics

Package Dimensions

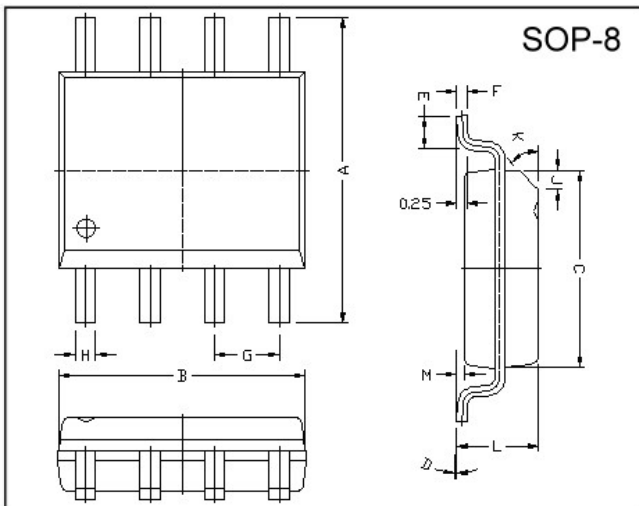

Functional Block Diagram

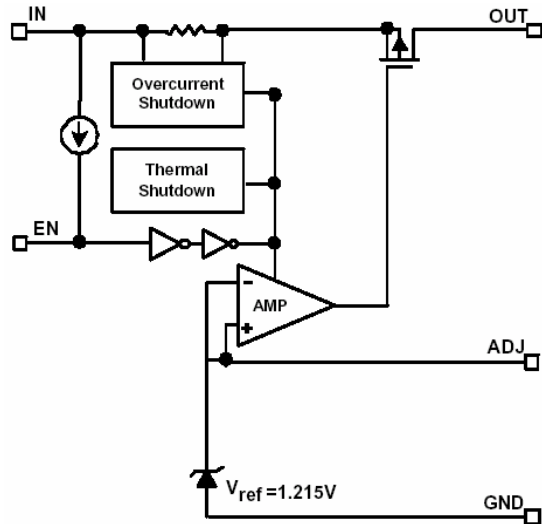

Marking :

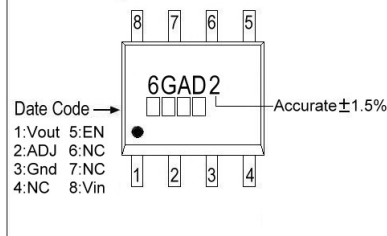

REF.	Millimeter		REF.	Millimeter	
	Min.	Max.		Min.	Max.
A	5.80	6.20	M	0.10	0.25
B	4.80	5.00	H	0.35	0.49
C	3.80	4.00	L	1.35	1.75
D	0°	8°	J	0.375 REF.	
E	0.40	0.90	K	45°	
F	0.19	0.25	G	1.27 TYP.	

Typical Application Circuit

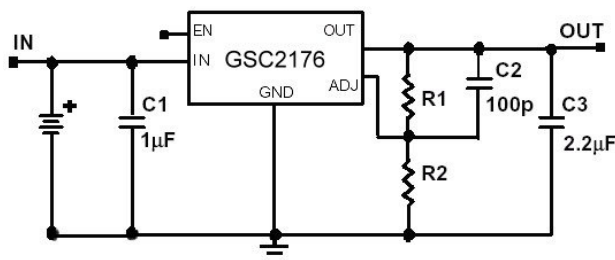

$$V_{OUT} = 1.215 * (1 + R1/R2)$$

C2 is unnecessary if R1 or R2 < 20KΩ

R1 and R2 use resistance value within 1% accuracy for correct VOUT

Absolute Maximum Ratings

Parameter	Symbol	Ratings	Unit
Input Max Voltage	V _{IN}	8	V
Output Current	I _{OUT}	P _D /(V _{IN} -V _O)	mA
Output Voltage	V _{OUT}	Gnd-0.3 to V _{IN} +0.3	V
Operating Ambient Temperature	T _{opr}	-40 ~ +85	°C
Junction Temperature	T _j	-40 ~ +125	°C
Maximum Junction Temperature	T _{j Max}	150	°C
Internal Power Dissipation	P _D	810	mW
EDS Classification		B	

Electrical Characteristics T_A=25°C unless otherwise noted

Parameter	Symbol	Condition	Min	TYP	Max	Unit	
Output Voltage	V _{OUT(E)} (Note1)	I _O =1mA, V _{IN} =V _{OUT(T)} +2V	-1.5	V _{OUT(T)} (Note2)	1.5	%	
Output Current	I _O	V _O >1.2V	600	-	-	mA	
Current Limit	I _{LIM}	V _O >1.2V	600	800	-	mA	
Short Circuit Current	I _{SC}	V _{IN} =V _{OUT(T)} +1V, V _O <0.8V	-	300	600	mA	
Load Regulation	REG _{LOAD}	V _{IN} =V _{OUT(T)} +2V, I _O =1mA to 600mA	-	0.2	1	%	
Dropout Voltage	V _{DROPOUT}	I _O =600mA V _O =V _{OUT(E)} -2%	1.5V<V _{OUT(T)} ≤2.0V	-	-	1400	mV
			2.0V<V _{OUT(T)} ≤2.8V	-	-	800	
			2.8V<V _{OUT(T)}	-	-	600	
Ground Pin Current	I _{GNND}	V _{IN} =V _{OUT(T)} +2V, I _O =1mA to 600mA	-	30	-	μA	
Line Regulation	REG _{LINE}	I _O =1mA V _{IN} =V _{OUT(T)} +1 to V _{OUT(T)} +2	V _{OUT(T)} <2.0V	-	-	0.15	%
			V _{OUT(T)} ≥2.0V	-	0.02	0.1	
Input Voltage	V _{IN}		Note3	-	7	V	
Over Temperature Shutdown	OTS		-	150	-	°C	
Over Temperature Hysteresis	OTH		-	30	-	°C	
Output Voltage Temperature Coefficient	TC		-	30	-	ppm/°C	
Power Supply Rejection	PSRR	I _O =100mA C _O =2.2μF	f=1kHz	-	50	-	dB
			f=10kHz	-	20	-	
			f=100kHz	-	15	-	
Output Voltage Noise	e _N	f=10Hz~100kHz, I _O =10mA, C _O =2.2μF	-	30	-	μVrms	
ADJ Reference Voltage	V _{REF}		1.203	1.215	1.227	V	
EN Input Threshold	V _{EH}	V _{IN} =2.7V to 7V	2.0	-	V _{IN}	V	
	V _{EL}	V _{IN} =2.7V to 7V	0	-	0.4	V	
EN Input Bias Current	I _{EH}	V _{EN} =V _{IN} , V _{IN} =2.7V to 7V	-	-	0.1	μA	
	I _{EL}	V _{EN} =0V, V _{IN} =2.7V to 7V	-	-	0.5	μA	
Shutdown Supply Current	I _{SD}	V _{IN} =5V, V _O =0V, V _{EN} <V _{EL}	-	0.5	0.1	μA	

Note 1: V_{OUT(E)} =Effective Output Voltage (i.e. the output voltage when "V_{OUT(T)} + 2.0V" is provided at the V_{IN} pin while maintaining a certain I_{OUT} value).

2: V_{OUT(T)} =Specified Output Voltage

3: V_{IN(MIN)} =V_{OUT}+V_{DROPOUT}

Ordering Information (contd.)

Part Number	Marking	Output Voltage	Part Number	Marking	Output Voltage
GSC2176-AD	6GAD2 XXXX	Adjustable			

Detailed Description

The GSC2176 of COMS regulator contain a PMOS pass transistor, voltage reference, error amplifier, over-current protection, and thermal shutdown.

The P-channel pass transistor receives data from the error amplifier, over-current shutdown, and thermal protection circuits. During normal operation, the error amplifier compares the output voltage to a precision reference. Over-current and Thermal shutdown circuits become active when the junction temperature exceeds 150°C, or the current exceeds 600mA. During thermal shutdown, the output voltage remains low. Normal operation is restored when the junction temperature drops below 120°C.

The GSC2176 switches from voltage mode to current mode when the load exceeds the rated output current. This prevents over-stress. The GSC2176 also incorporates current fold-back to reduce power dissipation when the output is short circuited. This feature becomes active when the output drops below 0.8 volts, and reduces the current flow by 65%. Full current is restored when the voltage exceeds 0.8 volts.

External Capacitors

The GSC2176 is stable with an output capacitance to ground of 2.2 μ F or greater. Ceramic capacitors have the lowest ESR, and will offer the best AC performance. Conversely, Aluminum Electrolytic capacitors exhibit the highest ESR, resulting in the poorest AC response. Unfortunately, large value ceramic capacitors are comparatively expensive. One option is to parallel a 0.1 μ F ceramic capacitor with a 10 μ F Aluminum Electrolytic. The benefit is low ESR, high capacitance, and low overall cost.

A second capacitor is recommended between the input and ground to stabilize V_{IN} . The input capacitor should be at least 0.1 μ F to have a beneficial effect.

All capacitors should be placed in close proximity to the pins. A "Quiet" ground termination is desirable. This can be achieved with a "Star" connection.

Enable

The Enable pin normally floats high. When actively, pulled low, the PMOS pass transistor shuts off, and all internal circuits are powered down. In this state, the quiescent current is less than 1 μ A. This pin behaves much like an electronic switch.

ADJ

The ADJ pin is the positive input to the error amplifier which, due to the PMOS pass element inversion, means it is actually the negative input of the LDO feedback loop. The feedback works to keep the voltage at the ADJ pin 1.215V with respect to ground. Since the internal circuitry at the ADJ pin is essentially an ESD protected CMOS gate the input current at the ADJ pin is virtually zero.

Characteristics Curve

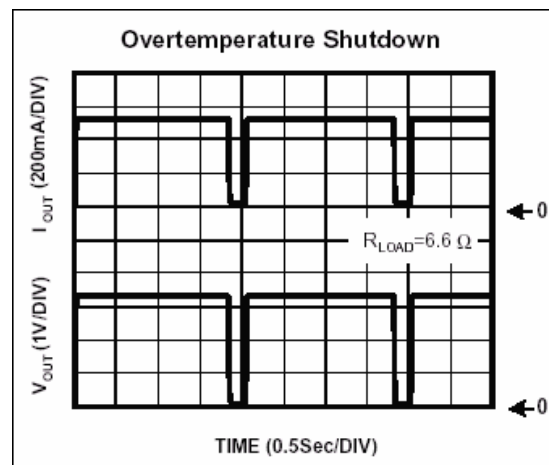
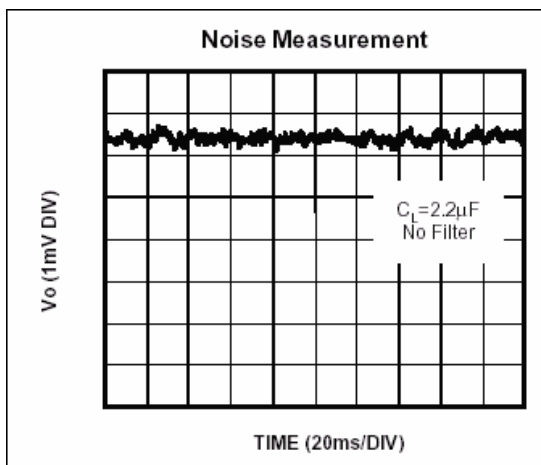
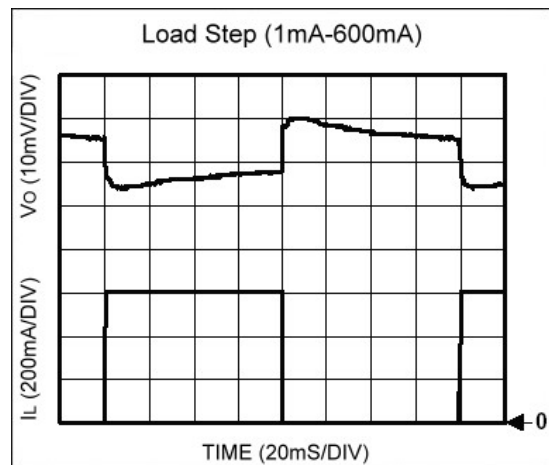
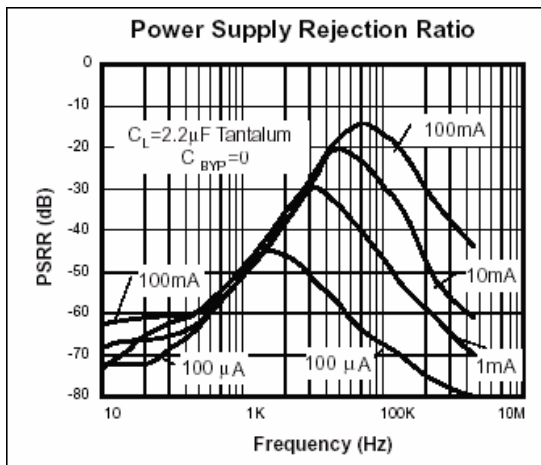
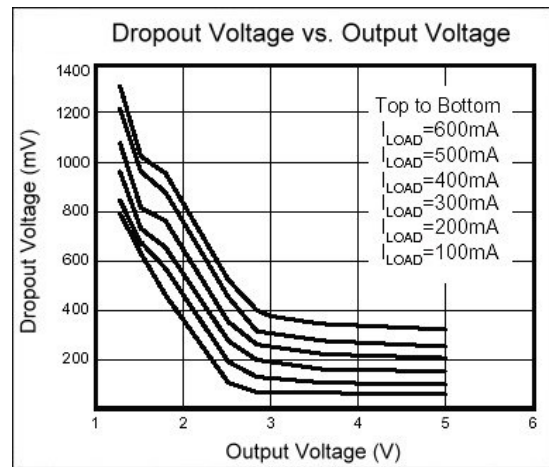
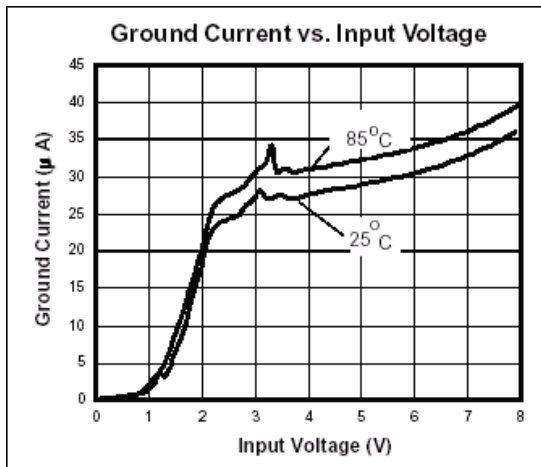

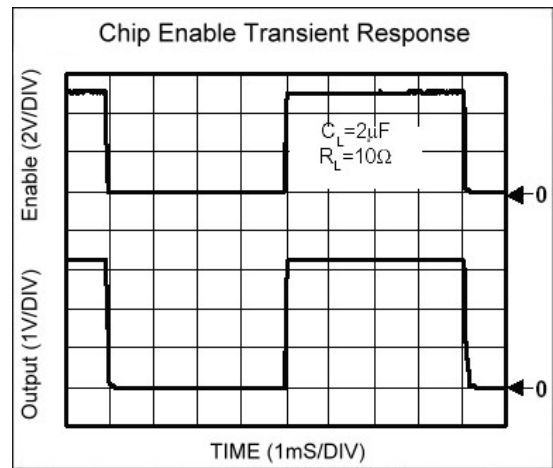
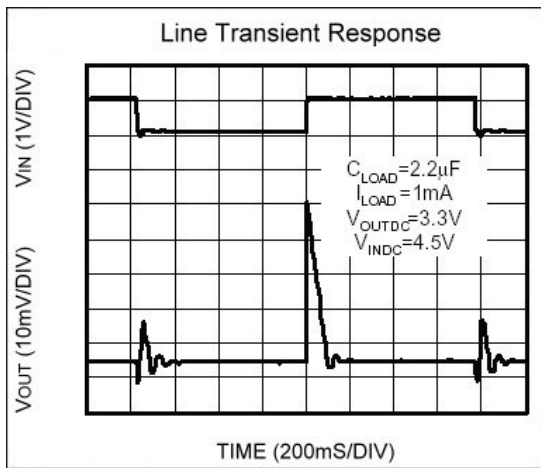
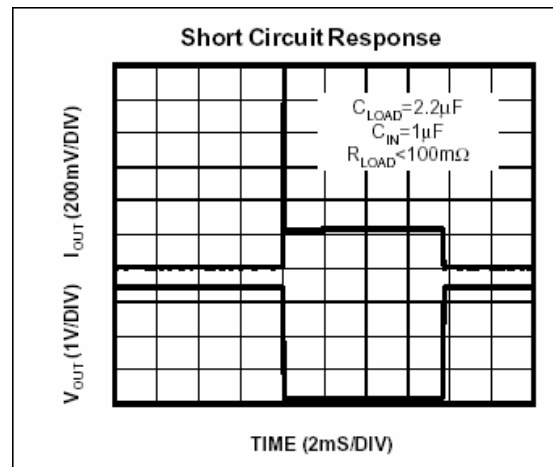
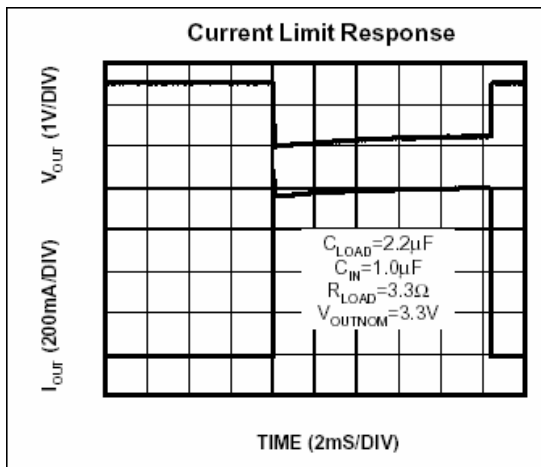

External Resistor Divider Table

R1(K Ohm)	1	2	3	4	5	6	7	8	9	10
VOUT	$R2(K\ Ohm)=(1.215*R1(K\ Ohm))/(V_{OUT}-1.215)$									
1.30	14.29	28.59	42.88	57.18	71.47	85.76	100.06	114.35	128.65	142.94
1.35	9.00	18.00	27.00	36.00	45.00	54.00	63.00	72.00	81.00	90.00
1.40	6.57	13.14	19.70	26.27	32.84	39.41	45.97	52.54	59.11	65.68
1.45	5.17	10.34	15.51	20.68	25.85	31.02	36.19	41.36	46.53	51.70
1.50	4.26	8.53	12.79	17.05	21.32	25.58	29.84	34.11	38.37	42.63
1.55	3.63	7.25	10.88	14.51	18.13	21.76	25.39	29.01	32.64	36.27
1.60	3.16	6.31	9.47	12.62	15.78	18.94	22.09	25.25	28.40	31.56
1.65	2.79	5.59	8.38	11.17	13.97	16.76	19.55	22.34	25.14	27.93
1.70	2.51	5.01	7.52	10.02	12.53	15.03	17.54	20.04	22.55	25.05
1.75	2.27	4.54	6.81	9.08	11.36	13.63	15.90	18.17	20.44	22.71
1.80	2.08	4.15	6.23	8.31	10.38	12.46	14.54	16.62	18.69	20.77
1.85	1.91	3.83	5.74	7.65	9.57	11.48	13.39	15.31	17.22	19.13
1.90	1.77	3.55	5.32	7.09	8.87	10.64	12.42	14.19	15.96	17.74
1.95	1.65	3.31	4.96	6.61	8.27	9.92	11.57	13.22	14.88	16.53
2.00	1.55	3.10	4.64	6.19	7.74	9.29	10.83	12.38	13.93	15.48
2.05	1.46	2.91	4.37	5.82	7.28	8.73	10.19	11.64	13.10	14.55
2.10	1.37	2.75	4.12	5.49	6.86	8.24	9.61	10.98	12.36	13.73
2.15	1.30	2.60	3.90	5.20	6.50	7.80	9.10	10.40	11.70	12.99
2.20	1.23	2.47	3.70	4.93	6.17	7.40	8.63	9.87	11.10	12.34
2.25	1.71	2.35	3.52	4.70	5.87	7.04	8.22	9.39	10.57	11.74
2.30	1.12	2.24	3.36	4.48	5.60	6.72	7.84	8.96	10.08	11.20
2.35	1.07	2.14	3.21	4.28	5.35	6.42	7.49	8.56	9.63	10.70
2.40	1.03	2.05	3.08	4.10	5.13	6.15	7.18	8.20	9.23	10.25
2.45	0.98	1.97	2.95	3.94	4.92	5.90	6.89	7.87	8.85	9.84
2.50	0.95	1.89	2.84	3.78	4.73	5.67	6.62	7.56	8.51	9.46
2.55	0.91	1.82	2.73	3.64	4.55	5.46	6.37	7.28	8.19	9.10
2.60	0.88	1.75	2.63	3.51	4.39	5.26	6.14	7.02	7.90	8.77
2.65	0.85	1.69	2.54	3.39	4.23	5.08	5.93	6.77	7.62	8.47
2.70	0.82	1.64	2.45	3.27	4.09	4.91	5.73	6.55	7.36	8.18
2.75	0.79	1.58	2.37	3.17	3.96	4.75	5.54	6.33	7.12	7.92
2.80	0.77	1.53	2.30	3.07	3.83	4.60	5.37	6.13	6.90	7.67
2.85	0.74	1.49	2.23	2.97	3.72	4.46	5.20	5.94	6.69	7.43
2.90	0.72	1.44	2.16	2.88	3.61	4.33	5.05	5.77	6.49	7.21
2.95	0.70	1.40	2.10	2.80	3.50	4.20	4.90	5.60	6.30	7.00
3.00	0.68	1.36	2.04	2.72	3.40	4.08	4.76	5.45	6.13	6.81
3.05	0.66	1.32	1.99	2.65	3.31	3.97	4.63	5.30	5.96	6.62
3.10	0.64	1.29	1.93	2.58	3.22	3.87	4.51	5.16	5.80	6.45
3.15	0.63	1.26	1.88	2.51	3.14	3.77	4.40	5.02	5.65	6.28
3.20	0.61	1.22	1.84	2.45	3.06	3.67	4.28	4.90	5.51	6.12
3.25	0.60	1.19	1.79	2.39	2.99	3.58	4.18	4.78	5.37	5.97
3.30	0.58	1.17	1.75	2.33	2.91	3.50	4.08	4.66	5.24	5.83

External Resistor Divider Table

R1(K Ohm)	1	2	3	4	5	6	7	8	9	10
VOUT	$R2(K\text{ Ohm})=(1.215*R1(K\text{ Ohm}))/(V_{OUT}-1.215)$									
3.35	0.57	1.14	1.71	2.28	2.85	3.41	3.98	4.55	5.12	5.69
3.40	0.56	1.11	1.67	2.22	2.78	3.34	3.89	4.45	5.00	5.56
3.45	0.54	1.09	1.63	2.17	2.72	3.26	3.81	4.35	4.89	5.44
3.50	0.53	1.06	1.60	2.13	2.66	3.19	3.72	4.25	4.79	5.32
3.55	0.52	1.04	1.56	2.08	2.60	3.12	3.64	4.16	4.68	5.20
3.60	0.51	1.02	1.53	2.04	2.55	3.06	3.57	4.08	4.58	5.09
3.65	0.50	1.00	1.50	2.00	2.49	2.99	3.49	3.99	4.49	4.99
3.70	0.49	0.98	1.47	1.96	2.44	2.93	3.42	3.91	4.40	4.89
3.75	0.48	0.96	1.44	1.92	2.40	2.88	3.36	3.83	4.31	4.79
3.80	0.47	0.94	1.41	1.88	2.35	2.82	3.29	3.76	4.23	4.70
3.85	0.46	0.92	1.38	1.84	2.31	2.77	3.23	3.69	4.15	4.61
3.90	0.45	0.91	1.36	1.81	2.26	2.72	3.17	3.62	4.07	4.53
3.95	0.44	0.89	1.33	1.78	2.22	2.67	3.11	3.55	4.00	4.44
4.00	0.44	0.87	1.31	1.75	2.18	2.62	3.05	3.49	3.93	4.36
4.05	0.43	0.86	1.29	1.71	2.14	2.57	3.00	3.43	3.86	4.29
4.10	0.42	0.84	1.26	1.68	2.11	2.53	2.95	3.37	3.79	4.21
4.15	0.41	0.83	1.24	1.66	2.07	2.48	2.90	3.31	3.73	4.14
4.20	0.41	0.81	1.22	1.63	2.04	2.44	2.85	3.26	3.66	4.07
4.25	0.40	0.80	1.20	1.60	2.00	2.40	2.80	3.20	3.60	4.00
4.30	0.39	0.79	1.18	1.58	1.97	2.36	2.76	3.15	3.54	3.94
4.35	0.39	0.78	1.16	1.55	1.94	2.33	2.71	3.10	3.49	3.88
4.40	0.38	0.76	1.14	1.53	1.91	2.29	2.67	3.05	3.43	3.81
4.45	0.38	0.75	1.13	1.50	1.88	2.25	2.63	3.00	3.38	3.76
4.50	0.37	0.74	1.11	1.48	1.85	2.22	2.59	2.96	3.33	3.70
4.55	0.36	0.73	1.09	1.46	1.82	2.19	2.55	2.91	3.28	3.64
4.60	0.36	0.72	1.08	1.44	1.79	2.15	2.51	2.87	3.23	3.59
4.65	0.35	0.71	1.06	1.41	1.77	2.12	2.48	2.83	3.18	3.54
4.70	0.35	0.70	1.05	1.39	1.74	2.09	2.44	2.79	3.14	3.49
4.75	0.34	0.69	1.03	1.37	1.72	2.06	2.41	2.75	3.09	3.44
4.80	0.34	0.68	1.02	1.36	1.69	2.03	2.37	2.71	3.05	3.39
4.85	0.33	0.67	1.00	1.34	1.67	2.01	2.34	2.67	3.01	3.34
4.90	0.33	0.66	0.99	1.32	1.65	1.98	2.31	2.64	2.97	3.30
4.95	0.33	0.65	0.98	1.30	1.63	1.95	2.28	2.60	2.93	3.25
5.00	0.32	0.64	0.96	1.28	1.61	1.93	2.25	2.57	2.89	3.21

Important Notice:

- All rights are reserved. Reproduction in whole or in part is prohibited without the prior written approval of GTM.
- GTM reserves the right to make changes to its products without notice.
- GTM semiconductor products are not warranted to be suitable for use in life-support Applications, or systems.
- GTM assumes no liability for any consequence of customer product design, infringement of patents, or application assistance.

Head Office And Factory:

- **Taiwan:** No. 17-1 Tatung Rd. Fu Kou Hsin-Chu Industrial Park, Hsin-Chu, Taiwan, R. O. C.
- TEL : 886-3-597-7061 FAX : 886-3-597-9220, 597-0785
- **China:** (201203) No.255, Jang-Jiang Tsai-Lueng RD. , Pu-Dung-Hsin District, Shang-Hai City, China
- TEL : 86-21-5895-7671 ~ 4 FAX : 86-21-38950165