



# SBFP420B

Continued from preceding page.

Parameter	Symbol	Conditions	Ratings			Unit
			min	typ	max	
Forward Transfer Gain	$ S_{21e} ^{21}$	$V_{CE}=1V, I_C=10mA, f=1.8GHz$		16		dB
	$ S_{21e} ^{22}$	$V_{CE}=2V, I_C=20mA, f=1.8GHz$	14	17		dB
Noise Figure	NF	$V_{CE}=2V, I_C=5mA, f=1.8GHz$		1.1	1.5	dB

## Electrical Connection (Top view)

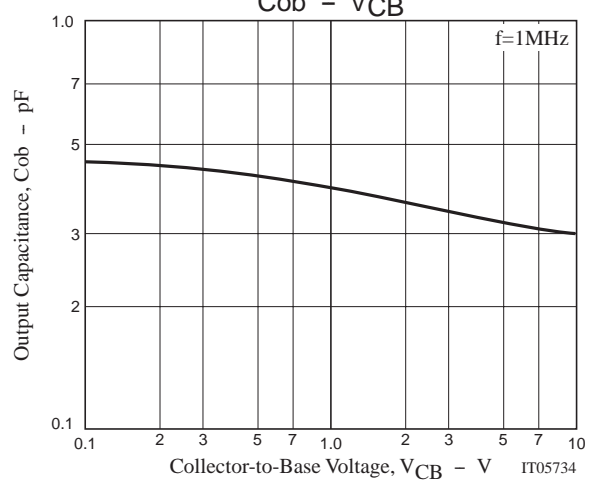
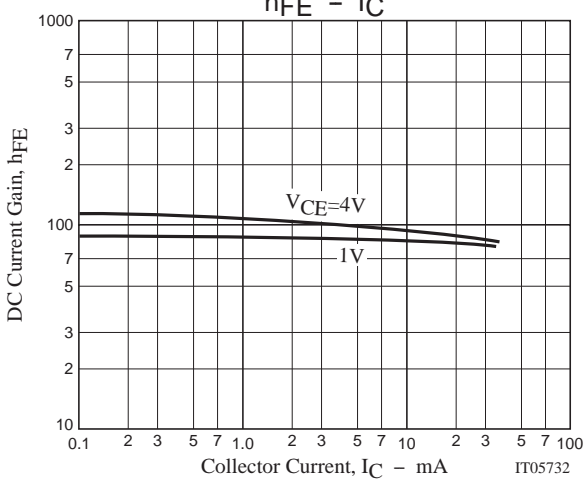
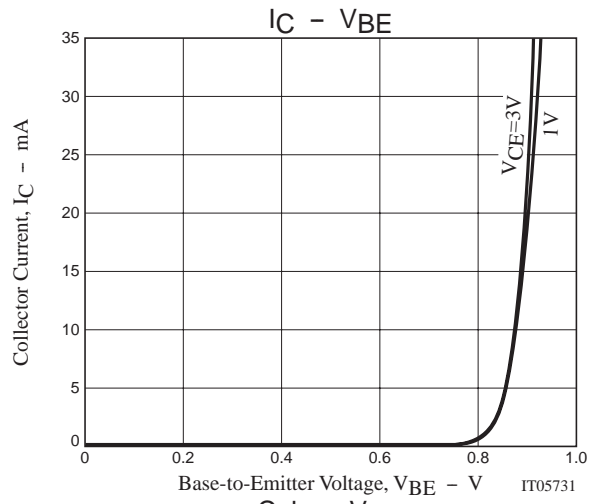
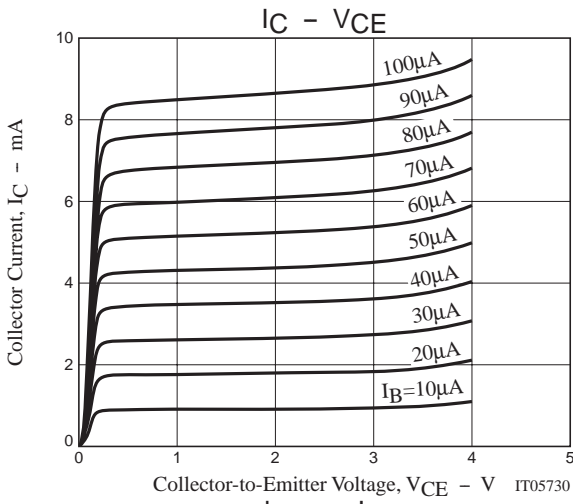
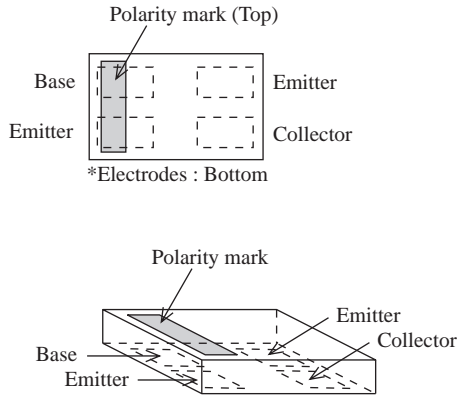

# SBFP420B

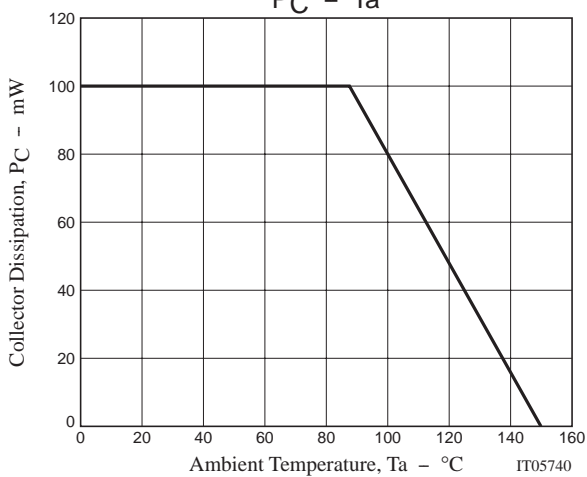
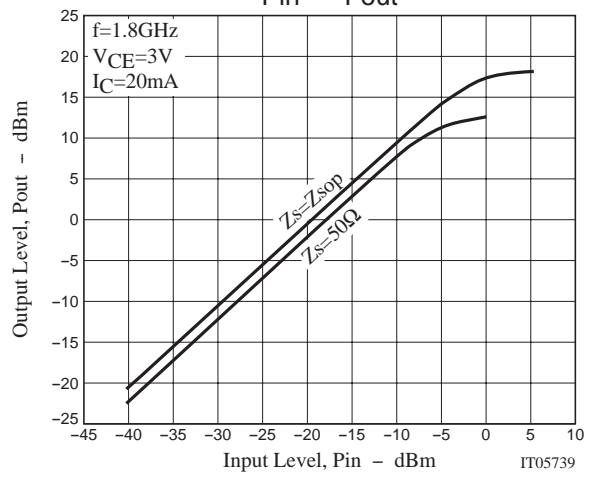
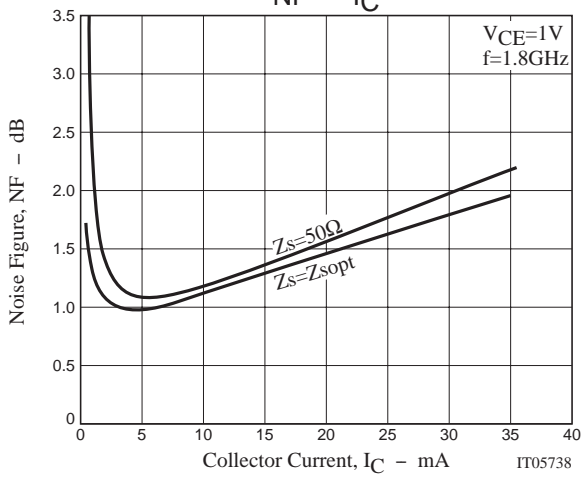
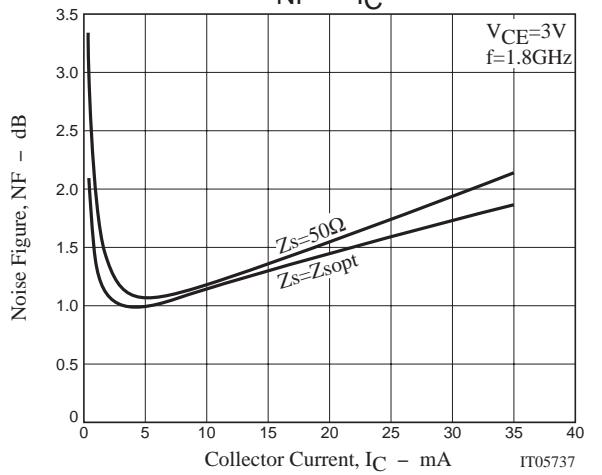
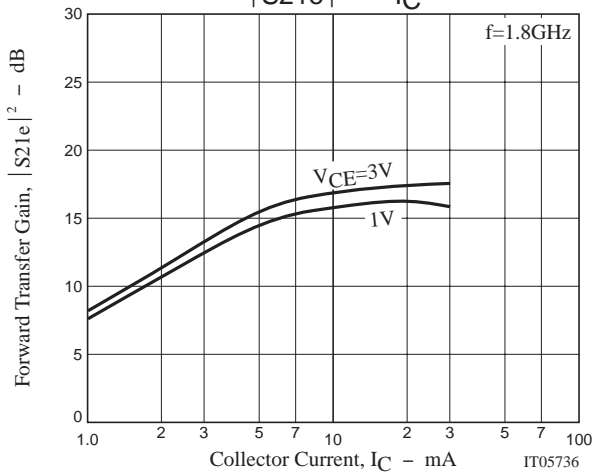
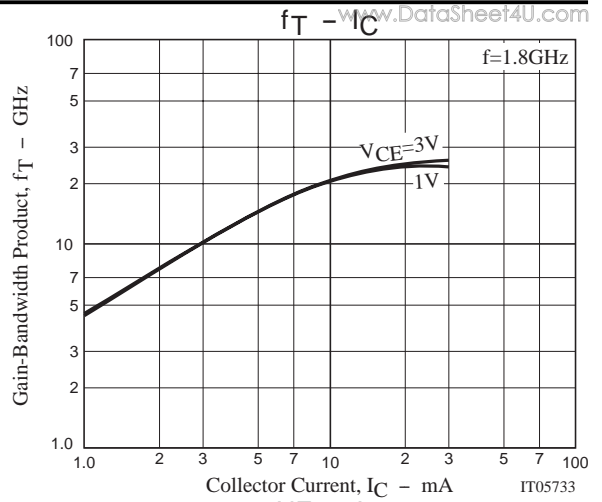
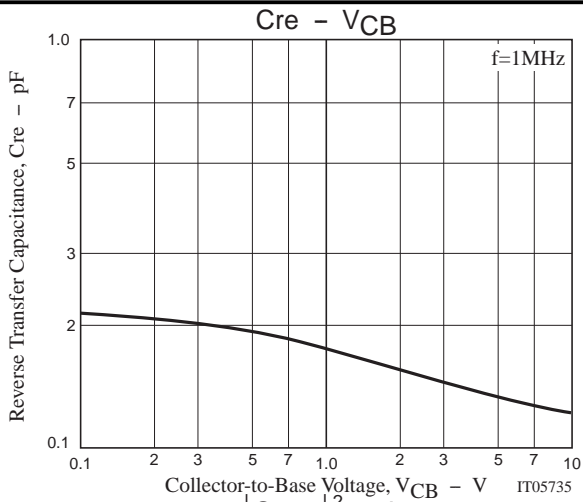

**SPICE PARAMETERS**

model : Gummel-Poon

Parameter	Value	Unit	Parameter	Value	Unit
IS	0.20045f	A	TF	6.7661p	S
BF	72.534		XTF	0.42199	
NF	1.2432		VTF	0.23794	V
VAF	28.383	V	ITF	1m	A
IKF	0.48731	A	PTF	0	deg
ISE	19.049f	A	CJC	234.53f	F
NE	2.0518		VJC	0.81969	V
BR	7.8287		MJC	0.30232	
NR	1.3325		XCJC	0.3	
VAR	19.705	V	TR	2.3249n	S
IKR	691.41m	A	FC	0.73234	
ISC	19.237a	A	CJS	0	F
NC	1.1724		VJS	0.75	V
RB	8.5757	Ω	MJS	0	
IRB	729.83μ	A	CC	100f	F
RBM	3.4849	Ω	Cbc	4f	F
RE	0.31111	Ω	Cbe	100f	F
RC	0.10105	Ω	Lb	0.6n	H
XTB	0		Lc	0.6n	H
EG	1.11	eV	Le	0.3n	H
XTI	3				
CJE	1.8063f	F			
VJE	0.8051	V			
MJE	0.46576				

**SCHEMATIC**

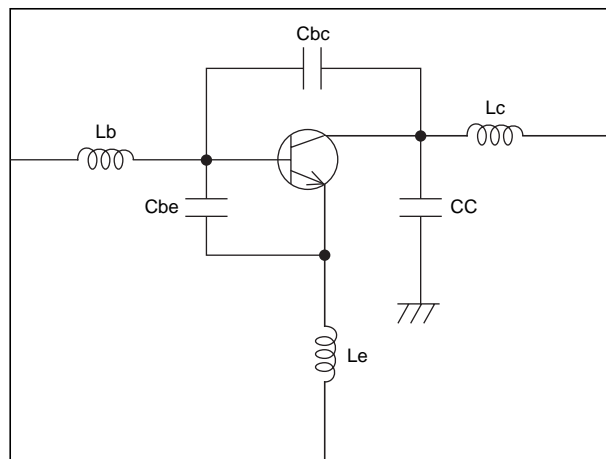

\*Information (including circuit diagrams and circuit parameters) herein is for example only ; it is not guaranteed for volume production.

# SBFP420B

## S Parameters (Common emitter)

V<sub>CE</sub>=1V, I<sub>C</sub>=1mA, Z<sub>O</sub>=50Ω

Freq(MHz)	S <sub>11</sub>	∠S <sub>11</sub>	S <sub>21</sub>	∠S <sub>21</sub>	S <sub>12</sub>	∠S <sub>12</sub>	S <sub>22</sub>	∠S <sub>22</sub>
200	0.966	-13.8	3.618	168.7	0.024	81.3	0.993	-8.0
400	0.942	-27.6	3.566	158.3	0.047	73.4	0.967	-15.6
600	0.920	-40.3	3.360	147.9	0.069	64.7	0.936	-22.7
800	0.895	-52.8	3.223	138.6	0.087	57.2	0.897	-29.4
1000	0.874	-64.5	3.039	128.2	0.104	50.3	0.854	-35.4
1200	0.859	-76.4	2.894	120.0	0.117	43.7	0.812	-40.9
1400	0.825	-86.3	2.703	112.4	0.128	38.1	0.776	-45.8
1600	0.800	-95.7	2.536	105.1	0.136	32.4	0.742	-50.3
1800	0.765	-104.6	2.361	98.2	0.143	27.5	0.709	-54.6
2000	0.756	-114.3	2.266	91.8	0.148	22.9	0.681	-58.3
2200	0.734	-122.3	2.114	85.4	0.152	18.9	0.656	-62.0
2400	0.716	-130.2	1.988	80.1	0.155	15.0	0.633	-65.5
2600	0.693	-137.3	1.867	74.2	0.156	11.8	0.612	-68.7
2800	0.688	-144.9	1.777	69.2	0.157	8.4	0.594	-71.9
3000	0.679	-151.1	1.692	63.7	0.158	5.4	0.579	-75.0
3200	0.665	-157.9	1.611	58.7	0.157	2.9	0.565	-78.0
3400	0.654	-163.4	1.537	54.8	0.156	0.5	0.550	-81.1
3600	0.654	-169.1	1.480	50.4	0.156	-1.6	0.538	-84.1
3800	0.647	-174.6	1.411	45.6	0.155	-3.5	0.527	-87.1
4000	0.644	-180.0	1.358	42.0	0.152	-5.4	0.518	-90.1
4200	0.638	174.8	1.314	37.7	0.151	-7.0	0.509	-93.2
4400	0.633	169.3	1.258	33.7	0.149	-7.9	0.502	-96.5
4600	0.632	164.8	1.214	30.0	0.148	-9.2	0.496	-99.6
4800	0.630	159.4	1.173	25.8	0.146	-9.9	0.489	-102.8
5000	0.627	155.2	1.142	22.6	0.145	-10.3	0.484	-106.0
5200	0.618	150.9	1.108	18.5	0.143	-10.8	0.481	-109.1
5400	0.622	146.6	1.062	15.7	0.142	-11.1	0.477	-112.4
5600	0.624	142.0	1.032	11.5	0.141	-11.1	0.474	-115.6
5800	0.622	137.2	1.003	9.1	0.141	-11.2	0.471	-118.8
6000	0.625	132.4	0.977	5.1	0.141	-10.8	0.467	-121.9

# SBFP420B

## S Parameters (Common emitter)

VCE=1V, IC=5mA, ZO=50Ω

Freq(MHz)	S <sub>11</sub>	∠S <sub>11</sub>	S <sub>21</sub>	∠S <sub>21</sub>	S <sub>12</sub>	∠S <sub>12</sub>	S <sub>22</sub>	∠S <sub>22</sub>
200	0.797	-29.6	14.707	159.5	0.022	73.5	0.953	-16.5
400	0.745	-52.0	13.292	142.4	0.041	64.1	0.861	-30.5
600	0.690	-73.2	11.337	128.3	0.054	54.8	0.761	-41.6
800	0.635	-90.6	9.824	117.2	0.063	48.0	0.668	-50.2
1000	0.597	-106.2	8.447	106.7	0.070	43.9	0.592	-57.2
1200	0.569	-118.1	7.421	99.0	0.075	40.6	0.528	-62.8
1400	0.540	-128.5	6.557	92.5	0.080	38.1	0.482	-67.4
1600	0.530	-137.3	5.836	86.6	0.084	35.9	0.444	-71.6
1800	0.504	-146.0	5.243	81.4	0.088	34.3	0.411	-75.4
2000	0.506	-154.0	4.814	76.3	0.092	33.1	0.383	-78.7
2200	0.495	-161.0	4.376	71.4	0.096	32.3	0.362	-81.9
2400	0.490	-167.8	4.033	67.5	0.100	31.4	0.342	-85.0
2600	0.478	-173.7	3.721	63.2	0.104	30.6	0.325	-87.8
2800	0.485	-180.0	3.467	59.3	0.108	29.5	0.311	-90.4
3000	0.474	175.4	3.249	55.2	0.112	28.6	0.300	-93.2
3200	0.478	170.2	3.039	51.2	0.116	27.8	0.289	-95.9
3400	0.472	165.7	2.871	48.3	0.121	26.7	0.279	-98.7
3600	0.471	161.4	2.739	44.7	0.125	26.0	0.269	-101.7
3800	0.473	157.4	2.591	41.3	0.130	25.0	0.261	-104.5
4000	0.465	152.4	2.476	38.1	0.135	23.9	0.255	-107.5
4200	0.469	149.4	2.385	34.6	0.140	22.8	0.248	-110.6
4400	0.466	144.5	2.273	31.5	0.145	21.4	0.244	-114.0
4600	0.473	141.3	2.174	28.2	0.150	20.2	0.240	-117.0
4800	0.467	137.2	2.088	25.2	0.156	19.0	0.237	-120.3
5000	0.476	132.9	2.015	21.8	0.161	17.6	0.233	-123.4
5200	0.468	129.8	1.947	18.5	0.166	16.3	0.232	-126.7
5400	0.473	127.1	1.868	15.8	0.171	14.9	0.229	-129.8
5600	0.470	123.1	1.813	12.5	0.177	13.4	0.227	-132.9
5800	0.474	119.7	1.757	10.2	0.182	11.9	0.225	-136.1
6000	0.482	115.3	1.708	6.8	0.188	10.1	0.222	-138.9

# SBFP420B

## S Parameters (Common emitter)

V<sub>CE</sub>=1V, I<sub>C</sub>=10mA, Z<sub>O</sub>=50Ω

Freq(MHz)	S <sub>11</sub>	∠S <sub>11</sub>	S <sub>21</sub>	∠S <sub>21</sub>	S <sub>12</sub>	∠S <sub>12</sub>	S <sub>22</sub>	∠S <sub>22</sub>
200	0.662	-40.2	23.505	152.0	0.020	69.3	0.898	-23.5
400	0.591	-72.9	19.411	131.5	0.034	58.7	0.747	-40.8
600	0.536	-96.4	15.298	116.9	0.043	52.1	0.616	-52.5
800	0.499	-114.0	12.548	106.7	0.049	49.0	0.519	-60.8
1000	0.477	-128.9	10.407	97.3	0.055	47.7	0.447	-67.3
1200	0.463	-140.4	8.898	90.8	0.061	47.1	0.392	-72.4
1400	0.451	-147.9	7.738	85.0	0.066	45.7	0.354	-76.7
1600	0.442	-157.5	6.813	80.0	0.071	45.3	0.325	-80.9
1800	0.434	-164.1	6.069	75.6	0.076	44.5	0.299	-84.7
2000	0.444	-170.9	5.526	71.1	0.082	44.0	0.278	-88.2
2200	0.440	-177.2	5.004	66.9	0.087	43.2	0.262	-91.3
2400	0.434	177.4	4.586	63.5	0.093	42.3	0.247	-94.7
2600	0.432	170.5	4.236	59.6	0.099	41.4	0.235	-97.7
2800	0.439	167.3	3.931	56.2	0.105	39.9	0.224	-100.7
3000	0.435	163.2	3.673	52.6	0.111	38.8	0.215	-103.7
3200	0.434	159.3	3.426	49.0	0.117	37.8	0.207	-106.6
3400	0.434	154.4	3.237	46.1	0.124	36.2	0.199	-109.7
3600	0.431	151.6	3.079	42.8	0.129	34.9	0.193	-113.0
3800	0.431	147.8	2.911	39.6	0.136	33.0	0.188	-116.4
4000	0.436	143.0	2.777	36.7	0.142	31.6	0.182	-119.5
4200	0.433	139.9	2.673	33.4	0.149	30.0	0.178	-123.3
4400	0.437	136.9	2.543	30.6	0.155	28.6	0.175	-126.9
4600	0.442	133.1	2.432	27.3	0.161	26.6	0.174	-130.3
4800	0.437	128.9	2.332	24.4	0.167	24.7	0.171	-133.9
5000	0.442	125.6	2.249	21.5	0.174	23.0	0.169	-137.2
5200	0.436	123.6	2.167	18.3	0.180	21.2	0.168	-140.7
5400	0.443	120.5	2.080	15.6	0.187	19.2	0.167	-144.3
5600	0.442	117.0	2.018	12.5	0.193	17.4	0.166	-147.6
5800	0.445	113.0	1.957	10.3	0.199	15.4	0.164	-150.8
6000	0.454	110.1	1.897	6.9	0.206	13.3	0.163	-154.0

# SBFP420B

## S Parameters (Common emitter)

V<sub>CE</sub>=1V, I<sub>C</sub>=15mA, Z<sub>O</sub>=50Ω

Freq(MHz)	S <sub>11</sub>	∠S <sub>11</sub>	S <sub>21</sub>	∠S <sub>21</sub>	S <sub>12</sub>	∠S <sub>12</sub>	S <sub>22</sub>	∠S <sub>22</sub>
200	0.560	-51.1	28.841	147.1	0.019	69.4	0.855	-28.1
400	0.515	-87.8	22.378	125.3	0.030	60.5	0.669	-46.8
600	0.471	-111.0	16.951	111.3	0.037	54.4	0.534	-58.1
800	0.445	-128.2	13.565	101.8	0.044	51.6	0.442	-66.0
1000	0.436	-142.4	11.082	93.2	0.050	51.4	0.378	-72.0
1200	0.424	-152.4	9.392	87.1	0.055	51.0	0.330	-77.1
1400	0.422	-159.6	8.133	81.9	0.062	51.4	0.298	-81.5
1600	0.420	-167.3	7.132	77.4	0.068	50.5	0.274	-85.8
1800	0.415	-173.4	6.339	73.3	0.074	50.1	0.252	-89.8
2000	0.422	-178.7	5.757	69.0	0.080	49.2	0.234	-93.4
2200	0.423	175.7	5.206	65.0	0.086	48.1	0.221	-96.9
2400	0.423	170.7	4.768	61.8	0.093	46.8	0.209	-100.4
2600	0.417	165.8	4.389	58.3	0.100	46.0	0.199	-103.7
2800	0.427	161.3	4.080	54.9	0.105	44.1	0.189	-106.6
3000	0.428	158.7	3.807	51.4	0.112	42.7	0.183	-110.2
3200	0.426	153.2	3.554	47.9	0.119	41.4	0.176	-113.2
3400	0.423	149.5	3.349	45.3	0.126	39.5	0.169	-116.7
3600	0.424	146.9	3.188	42.1	0.133	38.0	0.164	-120.3
3800	0.420	143.2	3.017	39.0	0.140	36.3	0.159	-124.0
4000	0.426	139.2	2.884	36.1	0.146	34.4	0.156	-127.6
4200	0.428	135.7	2.756	32.9	0.153	32.5	0.152	-131.3
4400	0.429	132.5	2.626	30.1	0.159	30.6	0.151	-135.3
4600	0.430	129.0	2.518	27.1	0.167	28.5	0.149	-139.0
4800	0.426	126.0	2.408	24.2	0.173	26.7	0.148	-142.8
5000	0.435	123.1	2.331	21.2	0.180	24.8	0.147	-146.4
5200	0.431	120.2	2.236	18.1	0.186	22.8	0.147	-149.8
5400	0.437	117.9	2.148	15.7	0.193	20.6	0.147	-153.5
5600	0.431	113.9	2.080	12.6	0.199	18.6	0.146	-156.7
5800	0.440	111.1	2.022	10.1	0.206	16.7	0.145	-160.3
6000	0.442	107.4	1.966	7.0	0.213	14.6	0.144	-163.3



# SBFP420B

## S Parameters (Common emitter)

V<sub>CE</sub>=1V, I<sub>C</sub>=20mA, Z<sub>O</sub>=50Ω

Freq(MHz)	S <sub>11</sub>	∠S <sub>11</sub>	S <sub>21</sub>	∠S <sub>21</sub>	S <sub>12</sub>	∠S <sub>12</sub>	S <sub>22</sub>	∠S <sub>22</sub>
200	0.490	-60.8	32.300	143.6	0.017	69.2	0.815	-31.4
400	0.470	-98.5	23.945	121.3	0.028	58.2	0.614	-50.7
600	0.435	-122.3	17.681	107.8	0.035	56.9	0.479	-61.5
800	0.420	-138.9	13.993	98.9	0.041	55.3	0.393	-69.0
1000	0.417	-150.2	11.344	90.8	0.047	55.0	0.336	-75.1
1200	0.412	-160.0	9.570	85.0	0.053	55.0	0.293	-80.1
1400	0.417	-166.3	8.269	80.1	0.059	54.3	0.266	-84.5
1600	0.412	-172.3	7.233	75.8	0.066	53.9	0.244	-88.9
1800	0.410	-178.8	6.424	71.8	0.073	52.7	0.225	-93.1
2000	0.417	176.8	5.824	67.9	0.079	51.8	0.210	-97.0
2200	0.419	171.5	5.272	63.9	0.086	50.8	0.199	-100.6
2400	0.418	166.5	4.825	60.8	0.092	49.2	0.188	-104.2
2600	0.421	161.5	4.442	57.3	0.100	48.3	0.178	-107.8
2800	0.425	157.3	4.124	54.1	0.107	46.6	0.171	-111.1
3000	0.425	154.8	3.844	50.8	0.113	44.9	0.165	-114.3
3200	0.425	151.5	3.585	47.3	0.121	43.3	0.159	-117.5
3400	0.424	147.2	3.386	44.7	0.127	41.5	0.154	-121.5
3600	0.424	144.1	3.218	41.5	0.135	39.7	0.149	-125.3
3800	0.420	139.7	3.043	38.5	0.141	37.6	0.145	-128.9
4000	0.431	136.5	2.903	35.6	0.149	35.7	0.142	-132.8
4200	0.430	133.8	2.788	32.5	0.155	33.8	0.139	-137.1
4400	0.428	130.6	2.650	29.8	0.162	31.8	0.139	-141.3
4600	0.427	128.0	2.536	26.8	0.169	29.8	0.138	-144.9
4800	0.429	123.3	2.433	23.8	0.176	27.9	0.137	-148.6
5000	0.436	120.6	2.345	21.0	0.183	25.7	0.136	-152.3
5200	0.431	118.4	2.256	17.7	0.189	23.7	0.137	-155.8
5400	0.438	115.7	2.162	15.2	0.196	21.5	0.138	-159.5
5600	0.437	112.6	2.102	12.3	0.203	19.4	0.137	-162.8
5800	0.436	109.0	2.036	10.0	0.210	17.3	0.136	-166.3
6000	0.444	105.5	1.977	6.9	0.216	15.0	0.135	-169.7

# SBFP420B

## S Parameters (Common emitter)

VCE=3V, IC=1mA, ZO=50Ω

Freq(MHz)	S <sub>11</sub>	∠S <sub>11</sub>	S <sub>21</sub>	∠S <sub>21</sub>	S <sub>12</sub>	∠S <sub>12</sub>	S <sub>22</sub>	∠S <sub>22</sub>
200	0.972	-13.9	3.620	169.4	0.018	80.7	0.994	-6.5
400	0.940	-24.9	3.580	160.1	0.036	74.9	0.977	-12.8
600	0.940	-37.7	3.406	150.2	0.052	67.9	0.956	-18.8
800	0.910	-49.2	3.305	141.6	0.067	61.4	0.928	-24.5
1000	0.888	-60.1	3.131	131.8	0.080	53.8	0.896	-29.8
1200	0.864	-71.6	3.016	123.8	0.091	47.9	0.861	-34.8
1400	0.843	-81.1	2.837	116.5	0.100	42.3	0.830	-39.3
1600	0.817	-90.9	2.682	109.2	0.108	36.9	0.801	-43.5
1800	0.785	-99.9	2.510	102.4	0.113	32.6	0.772	-47.4
2000	0.769	-108.9	2.412	96.1	0.119	27.9	0.747	-51.0
2200	0.747	-117.3	2.256	89.7	0.122	23.9	0.724	-54.4
2400	0.727	-124.8	2.135	84.4	0.125	20.2	0.702	-57.7
2600	0.702	-132.4	2.008	78.4	0.126	16.8	0.682	-60.7
2800	0.701	-139.7	1.918	73.1	0.127	13.8	0.665	-63.7
3000	0.684	-146.3	1.832	68.1	0.128	10.8	0.650	-66.6
3200	0.673	-152.5	1.738	62.9	0.128	8.4	0.635	-69.4
3400	0.656	-158.8	1.659	58.9	0.128	6.1	0.621	-72.2
3600	0.654	-164.8	1.602	54.5	0.127	4.0	0.607	-75.0
3800	0.644	-170.4	1.523	49.9	0.126	2.2	0.597	-77.8
4000	0.636	-175.4	1.463	46.0	0.125	0.6	0.587	-80.5
4200	0.635	179.0	1.419	42.2	0.124	-0.5	0.577	-83.4
4400	0.628	173.7	1.361	38.1	0.122	-1.6	0.570	-86.4
4600	0.628	168.2	1.305	34.0	0.122	-2.5	0.562	-89.2
4800	0.619	163.2	1.260	30.0	0.120	-2.8	0.555	-92.2
5000	0.622	158.1	1.225	26.6	0.119	-3.2	0.550	-95.1
5200	0.607	154.4	1.189	22.8	0.119	-3.3	0.546	-98.0
5400	0.615	149.4	1.141	19.4	0.118	-3.5	0.542	-101.0
5600	0.612	144.9	1.118	15.7	0.119	-2.8	0.539	-104.0
5800	0.613	139.6	1.077	12.9	0.119	-2.6	0.534	-106.9
6000	0.615	135.3	1.047	9.6	0.119	-2.1	0.531	-109.9

# SBFP420B

## S Parameters (Common emitter)

V<sub>CE</sub>=3V, I<sub>C</sub>=5mA, Z<sub>O</sub>=50Ω

Freq(MHz)	S <sub>11</sub>	∠S <sub>11</sub>	S <sub>21</sub>	∠S <sub>21</sub>	S <sub>12</sub>	∠S <sub>12</sub>	S <sub>22</sub>	∠S <sub>22</sub>
200	0.808	-24.0	14.851	161.3	0.016	73.3	0.966	-12.6
400	0.772	-46.1	13.683	145.9	0.031	67.7	0.897	-23.5
600	0.706	-65.1	11.933	132.1	0.041	59.1	0.818	-32.4
800	0.655	-81.2	10.529	121.3	0.049	53.3	0.742	-39.5
1000	0.601	-95.2	9.205	110.6	0.056	48.6	0.675	-45.1
1200	0.573	-108.7	8.160	102.7	0.060	44.3	0.616	-49.8
1400	0.540	-119.1	7.255	95.9	0.065	41.8	0.573	-53.6
1600	0.519	-128.2	6.478	89.9	0.069	40.6	0.536	-57.2
1800	0.500	-137.5	5.835	84.4	0.073	39.0	0.503	-60.2
2000	0.489	-145.4	5.382	79.3	0.076	37.7	0.477	-62.9
2200	0.475	-153.2	4.898	74.2	0.080	36.7	0.456	-65.5
2400	0.460	-159.6	4.509	70.3	0.083	35.8	0.435	-68.0
2600	0.454	-166.9	4.159	65.7	0.087	34.8	0.419	-70.3
2800	0.457	-172.4	3.895	61.9	0.090	34.5	0.405	-72.5
3000	0.445	-177.6	3.639	57.9	0.094	33.6	0.393	-74.8
3200	0.442	176.9	3.410	53.9	0.098	32.7	0.381	-77.0
3400	0.435	172.2	3.216	50.8	0.102	31.9	0.370	-79.3
3600	0.438	167.6	3.066	47.4	0.106	30.8	0.360	-81.5
3800	0.432	163.3	2.900	43.8	0.110	30.1	0.351	-84.0
4000	0.430	158.6	2.771	40.7	0.115	28.8	0.344	-86.4
4200	0.432	154.2	2.663	37.2	0.119	27.5	0.336	-89.0
4400	0.430	150.0	2.529	34.1	0.123	26.8	0.330	-91.8
4600	0.433	146.4	2.420	30.8	0.129	25.7	0.325	-94.4
4800	0.432	142.1	2.319	27.6	0.133	24.6	0.321	-97.1
5000	0.436	137.9	2.244	24.6	0.138	23.1	0.316	-99.8
5200	0.430	135.1	2.166	21.4	0.143	21.7	0.314	-102.5
5400	0.441	131.7	2.073	18.7	0.147	20.4	0.310	-105.4
5600	0.439	128.2	2.017	15.5	0.153	19.2	0.308	-108.1
5800	0.437	123.6	1.944	12.9	0.158	17.5	0.305	-110.7
6000	0.444	120.0	1.890	9.5	0.163	16.0	0.302	-113.3

# SBFP420B

## S Parameters (Common emitter)

V<sub>CE</sub>=3V, I<sub>C</sub>=10mA, Z<sub>O</sub>=50Ω

Freq(MHz)	S <sub>11</sub>	∠S <sub>11</sub>	S <sub>21</sub>	∠S <sub>21</sub>	S <sub>12</sub>	∠S <sub>12</sub>	S <sub>22</sub>	∠S <sub>22</sub>
200	0.671	-34.9	23.953	154.7	0.015	70.8	0.927	-17.4
400	0.608	-62.7	20.493	135.6	0.025	63.8	0.808	-30.4
600	0.540	-84.5	16.604	121.1	0.034	56.5	0.699	-39.4
800	0.488	-102.0	13.870	110.6	0.040	52.7	0.610	-45.5
1000	0.459	-117.1	11.637	100.7	0.045	51.7	0.544	-50.2
1200	0.440	-128.2	10.011	93.9	0.049	50.6	0.492	-53.9
1400	0.423	-138.1	8.747	88.0	0.054	50.0	0.455	-57.1
1600	0.407	-147.4	7.719	82.8	0.058	49.1	0.425	-60.1
1800	0.397	-154.8	6.880	78.1	0.063	48.9	0.399	-62.8
2000	0.400	-162.1	6.279	73.6	0.068	48.1	0.378	-65.1
2200	0.393	-168.3	5.686	69.2	0.073	47.2	0.362	-67.4
2400	0.390	-175.1	5.209	65.7	0.078	46.6	0.346	-69.8
2600	0.383	178.6	4.807	61.8	0.082	45.0	0.333	-71.7
2800	0.390	174.6	4.465	58.3	0.088	44.3	0.323	-73.7
3000	0.386	170.3	4.165	54.7	0.093	43.1	0.313	-75.9
3200	0.385	166.0	3.891	51.1	0.099	42.0	0.304	-78.1
3400	0.383	161.5	3.664	48.3	0.104	40.6	0.295	-80.2
3600	0.384	157.5	3.487	45.0	0.110	39.2	0.286	-82.5
3800	0.380	152.6	3.299	41.8	0.116	37.8	0.279	-84.9
4000	0.380	148.3	3.145	38.9	0.121	36.1	0.272	-87.2
4200	0.386	144.6	3.014	35.8	0.126	34.9	0.265	-90.1
4400	0.387	141.5	2.865	32.9	0.132	33.1	0.262	-92.9
4600	0.384	137.9	2.740	29.6	0.137	31.4	0.257	-95.6
4800	0.381	133.8	2.623	26.8	0.143	29.8	0.253	-98.6
5000	0.392	130.7	2.532	23.9	0.149	28.0	0.250	-101.3
5200	0.383	127.0	2.443	20.7	0.154	26.2	0.249	-104.1
5400	0.391	125.1	2.337	18.2	0.159	24.3	0.247	-107.1
5600	0.395	121.2	2.268	15.1	0.166	22.8	0.244	-109.8
5800	0.394	117.2	2.191	12.7	0.172	20.7	0.242	-112.2
6000	0.399	113.7	2.134	9.4	0.178	19.0	0.240	-114.8

# SBFP420B

## S Parameters (Common emitter)

V<sub>CE</sub>=3V, I<sub>C</sub>=15mA, Z<sub>O</sub>=50Ω

Freq(MHz)	S <sub>11</sub>	∠S <sub>11</sub>	S <sub>21</sub>	∠S <sub>21</sub>	S <sub>12</sub>	∠S <sub>12</sub>	S <sub>22</sub>	∠S <sub>22</sub>
200	0.581	-41.7	29.624	150.5	0.014	69.8	0.897	-20.2
400	0.512	-73.8	24.021	129.9	0.023	62.9	0.749	-33.9
600	0.458	-96.9	18.679	115.5	0.030	58.0	0.632	-42.0
800	0.417	-114.8	15.225	105.6	0.035	56.8	0.546	-47.2
1000	0.393	-129.8	12.576	96.5	0.041	55.6	0.485	-51.2
1200	0.389	-139.2	10.715	90.1	0.045	55.1	0.438	-54.4
1400	0.374	-148.9	9.291	84.6	0.050	54.7	0.407	-57.2
1600	0.373	-156.6	8.161	79.8	0.055	54.2	0.382	-59.9
1800	0.366	-163.6	7.265	75.5	0.061	53.5	0.359	-62.5
2000	0.371	-169.8	6.608	71.3	0.066	53.3	0.340	-64.7
2200	0.368	-175.8	5.971	67.3	0.071	51.8	0.327	-66.9
2400	0.367	178.5	5.468	63.9	0.077	50.8	0.313	-69.3
2600	0.362	172.4	5.033	60.2	0.083	49.9	0.302	-71.3
2800	0.370	168.3	4.669	56.8	0.089	48.5	0.292	-73.1
3000	0.367	164.2	4.363	53.5	0.094	47.0	0.284	-75.5
3200	0.367	160.4	4.069	50.0	0.100	45.7	0.276	-77.6
3400	0.363	155.4	3.832	47.3	0.106	44.0	0.268	-79.8
3600	0.365	152.2	3.642	44.2	0.112	42.5	0.260	-82.0
3800	0.365	148.7	3.443	41.0	0.117	40.9	0.254	-84.5
4000	0.374	144.9	3.278	38.3	0.123	38.7	0.249	-86.9
4200	0.369	140.9	3.145	35.1	0.129	37.1	0.243	-89.7
4400	0.371	137.3	2.990	32.4	0.135	35.4	0.239	-92.6
4600	0.370	133.7	2.860	29.2	0.141	33.4	0.234	-95.4
4800	0.371	130.2	2.738	26.3	0.146	31.7	0.232	-98.2
5000	0.375	126.8	2.640	23.6	0.153	29.7	0.228	-101.1
5200	0.370	124.7	2.550	20.4	0.158	28.0	0.227	-104.0
5400	0.379	122.2	2.439	18.0	0.164	25.9	0.224	-106.9
5600	0.379	118.8	2.362	14.8	0.171	24.1	0.223	-109.5
5800	0.384	114.4	2.289	12.7	0.177	21.9	0.220	-112.2
6000	0.392	111.5	2.217	9.5	0.183	20.0	0.218	-114.8

# SBFP420B

## S Parameters (Common emitter)

V<sub>CE</sub>=3V, I<sub>C</sub>=20mA, Z<sub>O</sub>=50Ω

Freq(MHz)	S <sub>11</sub>	∠S <sub>11</sub>	S <sub>21</sub>	∠S <sub>21</sub>	S <sub>12</sub>	∠S <sub>12</sub>	S <sub>22</sub>	∠S <sub>22</sub>
200	0.492	-48.5	33.460	147.5	0.013	67.4	0.875	-22.2
400	0.457	-82.8	26.097	126.1	0.022	62.3	0.710	-35.7
600	0.405	-106.7	19.813	112.1	0.028	59.5	0.590	-43.1
800	0.387	-124.4	15.904	102.6	0.032	58.8	0.509	-47.7
1000	0.367	-138.1	13.013	94.0	0.038	59.3	0.453	-51.1
1200	0.365	-146.8	11.041	88.0	0.043	58.6	0.410	-54.0
1400	0.356	-155.4	9.556	82.8	0.048	57.8	0.382	-56.6
1600	0.353	-163.0	8.367	78.2	0.054	58.0	0.359	-59.2
1800	0.353	-169.6	7.434	74.0	0.060	56.7	0.338	-61.6
2000	0.353	-175.3	6.754	70.1	0.065	56.1	0.322	-63.8
2200	0.357	179.5	6.109	66.1	0.071	54.8	0.309	-66.0
2400	0.351	173.9	5.585	62.9	0.077	53.4	0.297	-68.3
2600	0.356	167.8	5.141	59.2	0.083	52.5	0.287	-70.4
2800	0.361	164.0	4.777	56.0	0.088	50.5	0.279	-72.3
3000	0.356	161.6	4.444	52.8	0.094	48.7	0.271	-74.5
3200	0.359	156.9	4.149	49.3	0.100	47.4	0.263	-76.7
3400	0.355	152.5	3.904	46.7	0.106	45.9	0.256	-78.8
3600	0.352	149.2	3.711	43.8	0.112	44.4	0.248	-80.8
3800	0.357	145.4	3.512	40.6	0.118	42.2	0.243	-83.6
4000	0.359	142.3	3.345	37.8	0.125	40.6	0.238	-86.0
4200	0.356	137.9	3.209	34.7	0.130	38.5	0.232	-88.8
4400	0.369	134.8	3.042	31.9	0.136	36.6	0.228	-91.8
4600	0.362	131.5	2.913	28.9	0.142	35.0	0.225	-94.4
4800	0.366	128.0	2.794	26.1	0.148	33.0	0.222	-97.4
5000	0.367	124.8	2.689	23.4	0.155	31.0	0.219	-100.3
5200	0.365	122.3	2.595	20.2	0.161	28.9	0.218	-103.1
5400	0.373	119.9	2.482	18.0	0.167	26.8	0.215	-106.1
5600	0.373	116.8	2.408	14.7	0.172	24.9	0.213	-108.7
5800	0.374	112.2	2.326	12.5	0.178	22.9	0.210	-111.5
6000	0.386	109.7	2.262	9.4	0.184	20.9	0.208	-113.9

- Specifications of any and all SANYO products described or contained herein stipulate the performance, characteristics, and functions of the described products in the independent state, and are not guarantees of the performance, characteristics, and functions of the described products as mounted in the customer's products or equipment. To verify symptoms and states that cannot be evaluated in an independent device, the customer should always evaluate and test devices mounted in the customer's products or equipment.
- SANYO Electric Co., Ltd. strives to supply high-quality high-reliability products. However, any and all semiconductor products fail with some probability. It is possible that these probabilistic failures could give rise to accidents or events that could endanger human lives, that could give rise to smoke or fire, or that could cause damage to other property. When designing equipment, adopt safety measures so that these kinds of accidents or events cannot occur. Such measures include but are not limited to protective circuits and error prevention circuits for safe design, redundant design, and structural design.
- In the event that any or all SANYO products(including technical data, services) described or contained herein are controlled under any of applicable local export control laws and regulations, such products must not be exported without obtaining the export license from the authorities concerned in accordance with the above law.
- No part of this publication may be reproduced or transmitted in any form or by any means, electronic or mechanical, including photocopying and recording, or any information storage or retrieval system, or otherwise, without the prior written permission of SANYO Electric Co., Ltd.
- Any and all information described or contained herein are subject to change without notice due to product/technology improvement, etc. When designing equipment, refer to the "Delivery Specification" for the SANYO product that you intend to use.
- Information (including circuit diagrams and circuit parameters) herein is for example only ; it is not guaranteed for volume production. SANYO believes information herein is accurate and reliable, but no guarantees are made or implied regarding its use or any infringements of intellectual property rights or other rights of third parties.

This catalog provides information as of June, 2003. Specifications and information herein are subject to change without notice.