

SPECIFICATION FOR LCD MODULE

Model No. TM12864NCAG

| | |
|----------------------|--------------|
| Prepared by: | Date: |
| Checked by : | Date: |
| Verified by : | Date: |
| Approved by: | Date: |

TIANMA MICROELECTRONICS CO., LTD

REVISION RECORD

| Date | Ref. Page | Revision No. | Revision Items | Check & Approval |
|-------------|------------------|---------------------|-----------------------|-----------------------------|
| | | | | |

1. General Specifications:

- 1.1 Display type: FSTN
- 1.2 Display color*:
 - Display color: Blue-Black
 - Background: White
- 1.3 Polarizer mode: Reflective/Positive
- 1.4 Viewing Angle: 6:00
- 1.5 Driving Method: 1/65Duty 1/9 Bias
- 1.6 Without backlight
- 1.7 Controller: S6B0724
- 1.8 Data Transfer: Serial
- 1.9 Operating Temperature: 0----+50°C
 - Storage Temperature: -20----+60°C
- 1.10 Outline Dimensions: Refer to outline drawing on next page
- 1.11 Dot Matrix: 128 X64
- 1.12 Dot Size: 0.39X0.39(mm)
- 1.13 Dot Pitch: 0.43X0.43 (mm)
- 1.14 Weight: 20g

* Color tone is slightly changed by temperature and driving voltage.

3. LCD Module Part Numbering System

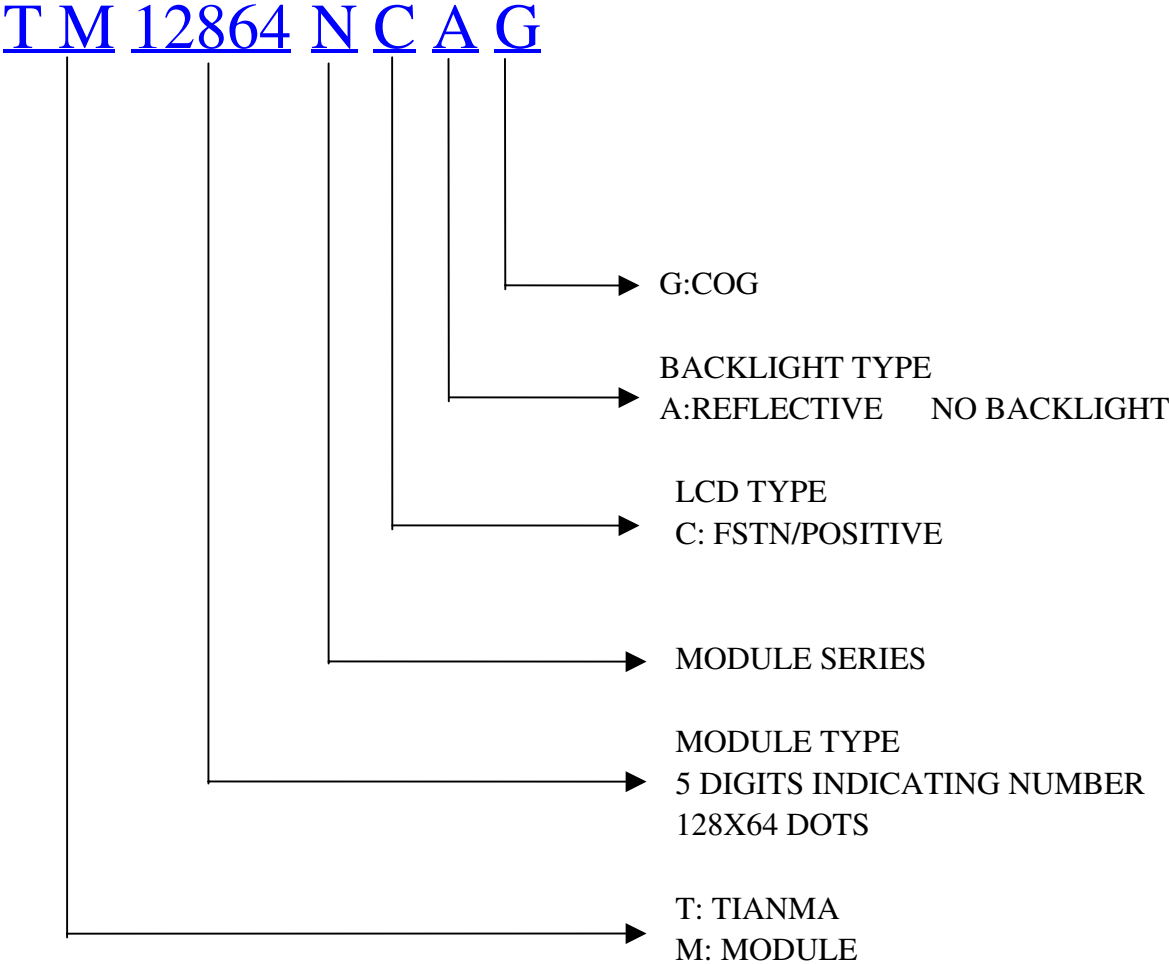

4 Circuit Block Diagram

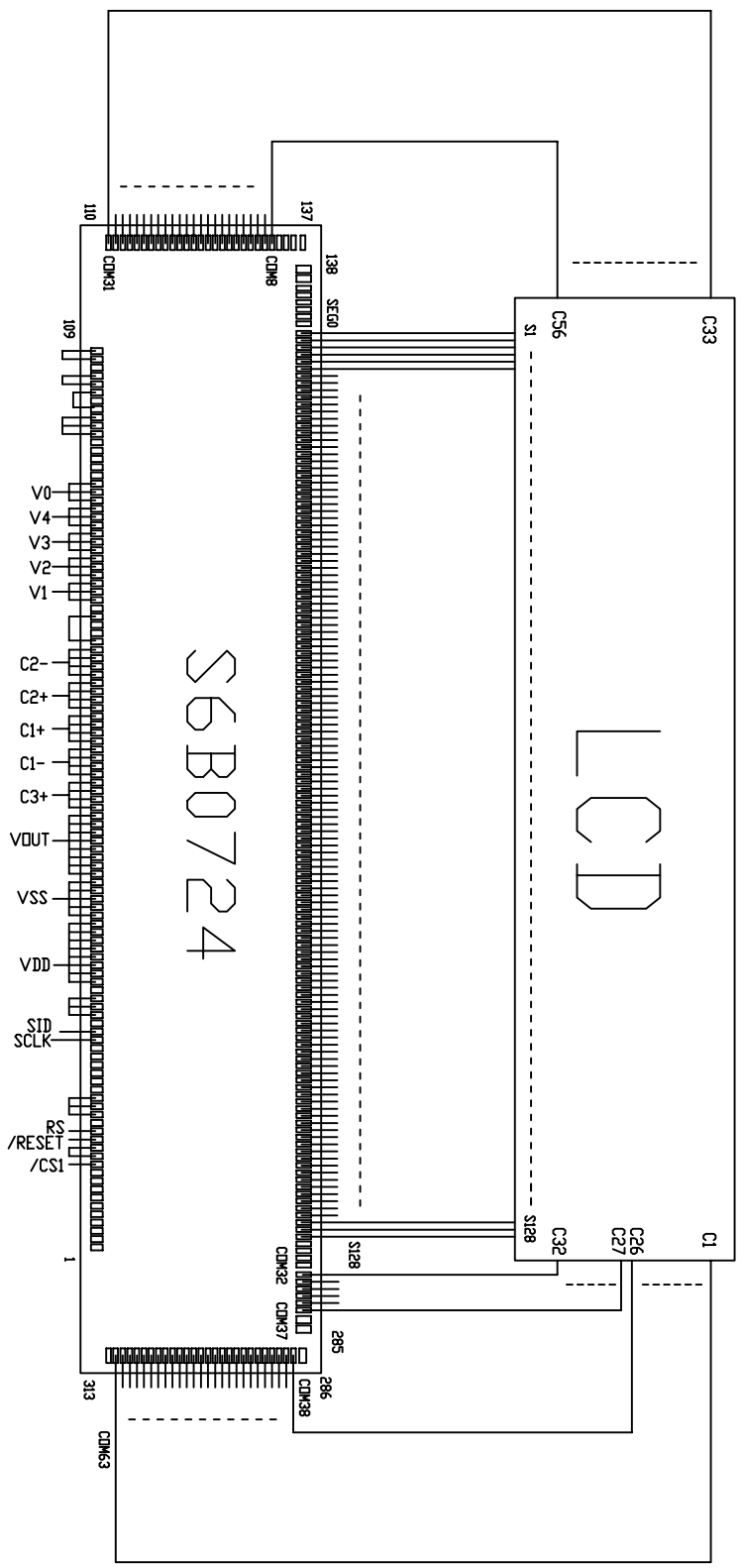

5 Absolute Maximum Ratings

| Item | Symbol | Min. | Max. | Unit | Remark |
|-----------------------------|-----------------|------|------|------|--------------------|
| Power Supply Voltage | $V_{DD}-V_{SS}$ | 2.4 | 3.6 | V | |
| LCD Driving Voltage | V_{LCD} | 4.5 | 15.0 | | |
| Operating Temperature Range | T_{OP} | 0 | +50 | °C | No Condensation |
| Storage Temperature Range | T_{ST} | -20 | +60 | | |

6 Electrical Specifications and Instruction Code

6.1 Electrical characteristics

| Item | Symbol | Min. | Typ. | Max. | Unit | |
|-------------------------------|--------------------------------------|------------------------------|--------------|------|--------------|---|
| Supply Voltage (Logic) | $V_{DD}-V_{SS}$ | 2.4 | 3.0 | 3.6 | V | |
| Supply Voltage (LCD Drive) | V_{LCD} | - | 9.0 | - | V | |
| Input Signal Voltage | High | V_{IH} ($V_{DD}=3.0$) | 0.8 V_{DD} | - | V_{DD} | V |
| | Low | V_{IL} ($V_{DD}=3.0$) | 0 | - | 0.2 V_{DD} | V |
| Supply current (Logic) | I_{DD} ($V_{DD}-V_{SS}=3.0V$) | - | - | 200 | μA | |

6.2 Interface Signals

| Pin No. | Symbol | Level | Description |
|---------|--------|-------|-------------------------------------|
| 1 | NC | - | No connection |
| 2 | V4 | - | Power supply voltage for LCD |
| 3 | V3 | - | Power supply voltage for LCD |
| 4 | V2 | - | Power supply voltage for LCD |
| 5 | V1 | - | Power supply voltage for LCD |
| 6 | V0 | 9.0V | Power supply voltage for LCD |
| 7 | C2- | - | Capacitor pin for voltage converter |
| 8 | C2+ | - | Capacitor pin for voltage converter |
| 9 | C1+ | - | Capacitor pin for voltage converter |
| 10 | C1- | - | Capacitor pin for voltage converter |
| 11 | C3+ | - | Capacitor pin for voltage converter |
| 12 | VOUT | - | DC/DC voltage converter output |
| 13 | VSS | 0V | Ground |
| 14 | VDD | 3.0V | Power supply voltage for logic |
| 15 | SI | H/L | Serial data input pin |
| 16 | SCL | H/L | Serial clock input pin |
| 17 | RS | H/L | Register select input pin |
| 18 | /RES | H/L | Reset input pin |
| 19 | /CS1 | H/L | Chip select input pin |
| 20 | NC | - | No connection |

6.3 Interface Timing Chart

Serial Interface Characteristics

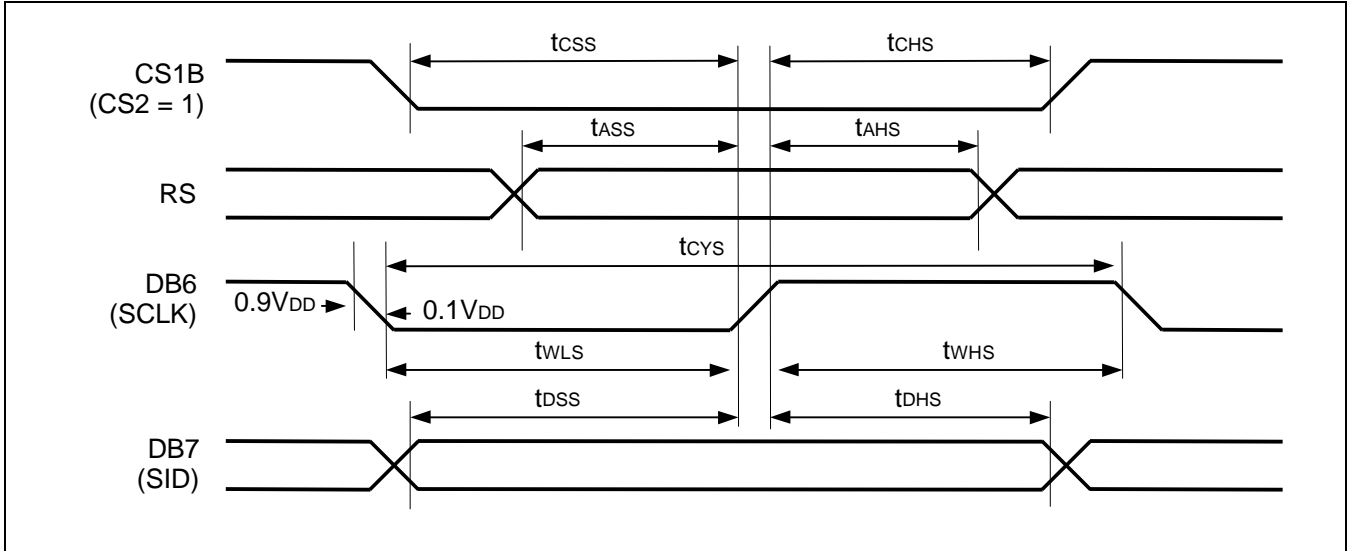

Serial Interface Characteristics

($V_{DD} = 2.4$ to $3.6V$, $T_a = -40$ to $+85^{\circ}C$)

| Item | Signal | Symbol | Min. | Typ. | Max. | Unit | Remark |
|-----------------------|------------|-----------|------|------|------|------|--------|
| Serial clock cycle | DB6 (SCLK) | t_{CYS} | 250 | - | - | | |
| SCLK high pulse width | DB6 (SCLK) | t_{WHS} | 100 | - | - | ns | |
| SCLK low pulse width | DB6 (SCLK) | t_{WLS} | 100 | - | - | | |
| Address setup time | RS | t_{ASS} | 150 | - | - | ns | |
| Address hold time | RS | t_{AHS} | 150 | - | - | | |
| Data setup time | DB7 (SID) | t_{DSS} | 100 | - | - | ns | |
| Data hold time | DB7 (SID) | t_{DHS} | 100 | - | - | | |
| CS1B setup time | CS1B | t_{CSS} | 150 | - | - | ns | |
| CS1B hold time | CS1B | t_{CHS} | 150 | - | - | | |

6.4 Instruction Code

INSTRUCTION DESCRIPTION

Instruction Table

×: Don't care

| Instruction | RS | RW | DB7 | DB6 | DB5 | DB4 | DB3 | DB2 | DB1 | DB0 | Description |
|--------------------------------|----|----|------------|-----|-------|--------|-----|-----|-----|------|--|
| Display ON / OFF | 0 | 0 | 1 | 0 | 1 | 0 | 1 | 1 | 1 | DON | Turn on/off LCD panel When DON = 0: display OFF When DON = 1: display ON |
| Initial display line | 0 | 0 | 0 | 1 | ST5 | ST4 | ST3 | ST2 | ST1 | ST0 | Specify DDRAM line for COM0 |
| Set page address | 0 | 0 | 1 | 0 | 1 | 1 | P3 | P2 | P1 | P0 | Set page address |
| Set column address MSB | 0 | 0 | 0 | 0 | 0 | 1 | Y7 | Y6 | Y5 | Y4 | Set column address MSB |
| Set column address LSB | 0 | 0 | 0 | 0 | 0 | 0 | Y3 | Y2 | Y1 | Y0 | Set column address LSB |
| Read status | 0 | 1 | BUSY | ADC | ONOFF | RESETB | 0 | 0 | 0 | 0 | Read the internal status |
| Write display data | 1 | 0 | Write data | | | | | | | | Write data into DDRAM |
| Read display data | 1 | 1 | Read data | | | | | | | | Read data from DDRAM |
| ADC select | 0 | 0 | 1 | 0 | 1 | 0 | 0 | 0 | 0 | ADC | Select SEG output direction When ADC = 0: normal direction (SEG0→SEG131) When ADC = 1: reverse direction (SEG131→SEG0) |
| Reverse display ON / OFF | 0 | 0 | 1 | 0 | 1 | 0 | 0 | 1 | 1 | REV | Select normal / reverse display When REV = 0: normal display When REV = 1: reverse display |
| Entire display ON / OFF | 0 | 0 | 1 | 0 | 1 | 0 | 0 | 1 | 0 | EON | Select normal/entire display ON When EON = 0: normal display. When EON = 1: entire display ON |
| LCD bias select | 0 | 0 | 1 | 0 | 1 | 0 | 0 | 0 | 1 | BIAS | Select LCD bias |
| Set modify-read | 0 | 0 | 1 | 1 | 1 | 0 | 0 | 0 | 0 | 0 | Set modify-read mode |
| Reset modify-read | 0 | 0 | 1 | 1 | 1 | 0 | 1 | 1 | 1 | 0 | release modify-read mode |
| Reset | 0 | 0 | 1 | 1 | 1 | 0 | 0 | 0 | 1 | 0 | Initialize the internal functions |
| SHL select | 0 | 0 | 1 | 1 | 0 | 0 | SHL | × | × | × | Select COM output direction When SHL = 0: normal direction (COM0→COM63) When SHL = 1: reverse direction (COM63→COM0) |
| Power control | 0 | 0 | 0 | 0 | 1 | 0 | 1 | VC | VR | VF | Control power circuit operation |
| Regulator resistor select | 0 | 0 | 0 | 0 | 1 | 0 | 0 | R2 | R1 | R0 | Select internal resistance ratio of the regulator resistor |
| Set reference voltage mode | 0 | 0 | 1 | 0 | 0 | 0 | 0 | 0 | 0 | 1 | Set reference voltage mode |
| Set reference voltage register | 0 | 0 | × | × | SV5 | SV4 | SV3 | SV2 | SV1 | SV0 | Set reference voltage register |
| Set static indicator mode | 0 | 0 | 1 | 0 | 1 | 0 | 1 | 1 | 0 | SM | Set static indicator mode |
| Set static indicator register | 0 | 0 | × | × | × | × | × | × | S1 | S0 | Set static indicator register |
| Power save | - | - | - | - | - | - | - | - | - | - | Compound Instruction of display OFF and entire display ON |

7 Optical Characteristics

7.1 Optical Characteristics

Ta=25°C

| Item | Symbol | Condition | Min. | Typ. | Max. | Unit | |
|----------------|------------|--|--|------|------|------|-----|
| Viewing Angle | θ_x | $C_r \geq 2$ | $\theta_y = 0^\circ$ | -30 | -- | 20 | Deg |
| | θ_y | | | | | | |
| Contrast Ratio | C_r | $\theta_x = 0^\circ$ $\theta_y = 0^\circ$ | 3.0 | - | - | | |
| Response Time | Turn on | T_{on} | $\theta_x = 0^\circ$ $\theta_y = 0^\circ$ | - | - | 300 | ms |
| | Turn off | T_{off} | | - | - | 300 | |

7.2 Definition of Optical Characteristics

7.2.1 Definition of Viewing Angle

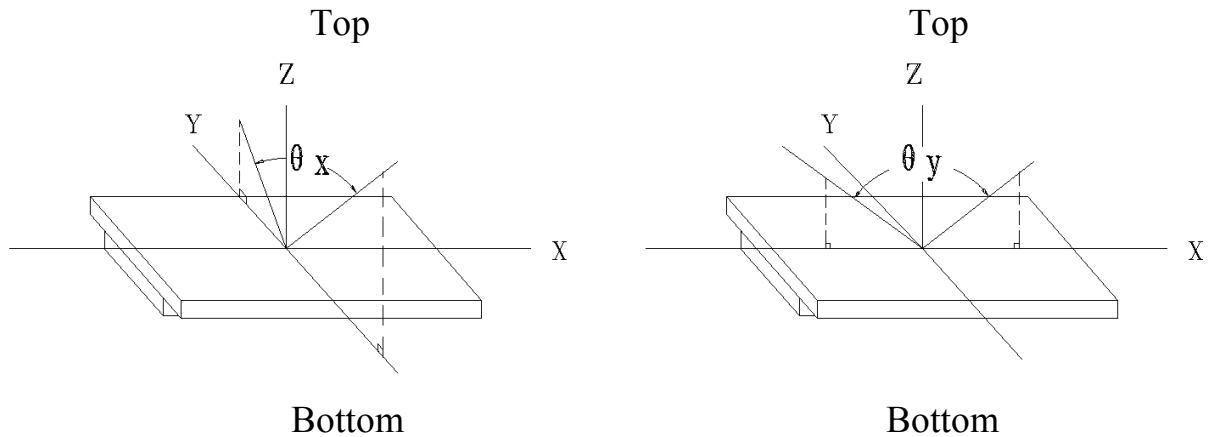

7.2.2 Definition of Contrast Ratio

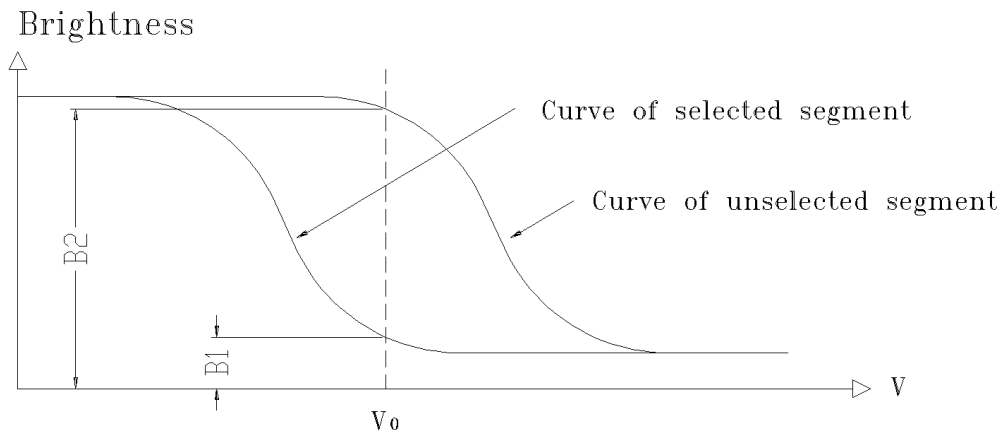

$$\text{Contrast Ratio} = B2/B1 = \frac{\text{unselected state brightness}}{\text{selected state brightness}}$$

Measuring Conditions:

- 1) Ambient Temperature: 25°C ;
- 2) Frame frequency: 64Hz

7.2.3 Definition of Response time

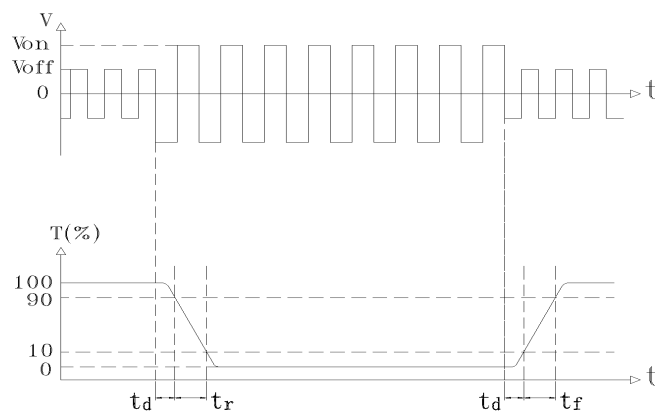

Turn on time: $t_{on} = t_d + t_r$ Turn off time: $t_{off} = t_d + t_f$

Measuring Condition:

- 1) Operating Voltage: 9.0V
- 2) Frame frequency: 64Hz

8 Reliability

8.1 Content of Reliability Test

Ta=25°C

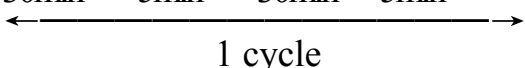
| No. | Test Item | Content of Test | Test condition |
|-----|------------------------------------|---|--|
| 1 | High Temperature Storage | Endurance test applying the high storage temperature for a long time | 60°C 96H |
| 2 | Low Temperature Storage | Endurance test applying the low storage temperature for a long time | -20°C 96H |
| 3 | High Temperature Operation | Endurance test applying the electric stress (voltage & current) and the thermal stress to the element for a long time | 50°C 96H |
| 4 | Low Temperature Operation | Endurance test applying the electric stress under low temperature for a long time | 0°C 96H |
| 5 | High Temperature /Humidity Storage | Endurance test applying the high temperature and high humidity storage for a long time | 40°C 90%RH 96H |
| 6 | Temperature Cycle | Endurance test applying the low and high temperature cycle $-20^{\circ}\text{C} \longleftrightarrow 25^{\circ}\text{C} \longleftrightarrow 60^{\circ}\text{C} \longleftrightarrow 25^{\circ}\text{C}$ $30\text{min} \quad 5\text{min} \quad 30\text{min} \quad 5\text{min}$  | -20°C/60°C 10 cycles |
| 7 | Vibration Test (package state) | Endurance test applying the vibration during transportation | 10Hz~150Hz, 50m/s ² , 40min |
| 8 | Shock Test (package state) | Endurance test applying the shock during transportation | Half- sine wave, 100m/s ² , 1ms |
| 9 | Atmospheric Pressure Test | Endurance test applying the atmospheric pressure during transportation by air | 40kPa 16H |

8.2 Failure Judgment Criterion

| Criterion Item | Test Item No. | | | | | | | | | Failure Judgement Criterion |
|--------------------------|--|---|---|---|---|---|---|---|---|-------------------------------------|
| | 1 | 2 | 3 | 4 | 5 | 6 | 7 | 8 | 9 | |
| Basic Specification | √ | √ | √ | √ | √ | √ | √ | √ | √ | Out of the basic Specification |
| Electrical specification | √ | √ | √ | √ | √ | | | | | Out of the electrical specification |
| Mechanical Specification | | | | | | | √ | √ | | Out of the mechanical specification |
| Optical Characteristic | √ | √ | √ | √ | √ | √ | | | √ | Out of the optical specification |
| Note | For test item refer to 8.1 | | | | | | | | | |
| Remark | Basic specification = Optical specification + Mechanical specification | | | | | | | | | |

9 QUALITY LEVEL

| Examination or Test | At $T_a=25^\circ\text{C}$ (unless otherwise stated) | Inspection | | | | |
|---|--|----------------|------|------|----|------------------------------|
| | | Min. | Max. | Unit | IL | AQL |
| External Visual Inspection | Under normal illumination and eyesight condition, the distance between eyes and LCD is 25cm. | See Appendix A | | | II | Major 1.0 Minor 2.5 |
| Display Defects | Under normal illumination and eyesight condition, display on inspection. | See Appendix B | | | II | Major 1.0 Minor 2.5 |
| Note: Major defects: Open segment or common, Short, Serious damages, Leakage Miner defects: Others Sampling standard conforms to GB2828 | | | | | | |

10 Precautions for Use of LCD Modules

10.1 Handling Precautions

10.1.1 The display panel is made of glass. Do not subject it to a mechanical shock by dropping it from a high place, etc.

10.1.2 If the display panel is damaged and the liquid crystal substance inside it leaks out, be sure not to get any in your mouth, if the substance comes into contact with your skin or clothes, promptly wash it off using soap and water.

10.1.3 Do not apply excessive force to the display surface or the adjoining areas since this may cause the color tone to vary.

10.1.4 The polarizer covering the display surface of the LCD module is soft and easily scratched. Handle this polarizer carefully.

10.1.5 If the display surface is contaminated, breathe on the surface and gently wipe it with a soft dry cloth. If still not completely clear, moisten cloth with one of the following solvents:

- Isopropyl alcohol
- Ethyl alcohol

Solvents other than those mentioned above may damage the polarizer. Especially, do not use the following:

- Water
- Ketone
- Aromatic solvents

10.1.6 Do not attempt to disassemble the LCD Module.

10.1.7 If the logic circuit power is off, do not apply the input signals.

10.1.8 To prevent destruction of the elements by static electricity, be careful to maintain an optimum work environment.

- a. Be sure to ground the body when handling the LCD Modules.
- b. Tools required for assembly, such as soldering irons, must be properly ground.
- c. To reduce the amount of static electricity generated, do not conduct assembly and other work under dry conditions.
- d. The LCD Module is coated with a film to protect the display surface. Be care when peeling off this protective film since static electricity may be generated.

10.2 Storage precautions

10.2.1 When storing the LCD modules, avoid exposure to direct sunlight or to the light of fluorescent lamps.

10.2.2 The LCD modules should be stored under the storage temperature range. If the LCD modules will be stored for a long time, the recommend condition is:

Temperature : $0^{\circ}\text{C} \sim 40^{\circ}\text{C}$

Relatively humidity: $\leq 80\%$

10.2.3 The LCD modules should be stored in the room without acid, alkali and harmful gas.

10.3 The LCD modules should be no falling and violent shocking during transportation, and also should avoid excessive press, water, damp and sunshine.

Appendix A

Inspection items and criteria for appearance defects

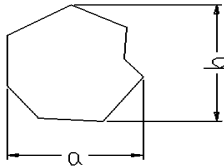
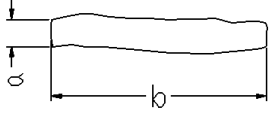
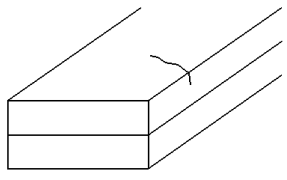
| Items | Contents | Criteria | | |
|---------------------------------|---|---|--|--|
| Protective Glue | | No clear defects | | |
| Cover Tape | | Covering all of the chip and no clear crimple | | |
| Leakage | | Not permitted | | |
| Rainbow | | According to the limit specimen | | |
| Polarizer | Wrong polarizer attachment | Not permitted | | |
| | Bubble between polarizer and glass | Not counted | Max. 3 defects allowed | |
| | | $\phi < 0.3\text{mm}$ | $0.3\text{mm} \leq \phi \leq 0.5\text{mm}$ | |
| | Scratches of polarizer | According to the limit specimen | | |
| Black spot (in viewing area) |  | Not counted | Max. 3 spots allowed | |
| | | $X < 0.2\text{mm}$ | $0.2\text{mm} \leq X \leq 0.5\text{mm}$ | |
| | | $X = (a+b)/2$ | | |
| Black line (in viewing area) |  | Not counted | Max. 3 lines allowed | |
| | | $a < 0.02\text{mm}$ | $0.02\text{mm} \leq a \leq 0.05\text{mm}$ $b \leq 2.0\text{mm}$ | |
| Progressive cracks |  | Not permitted | | |

Appendix A

Inspection item and criteria for appearance defects (continued)

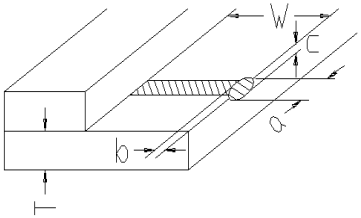
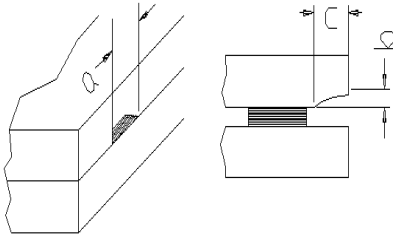
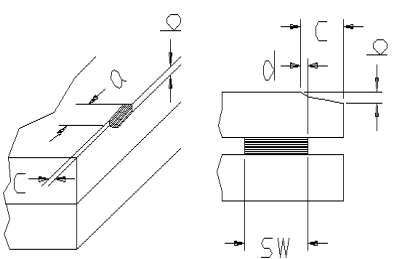
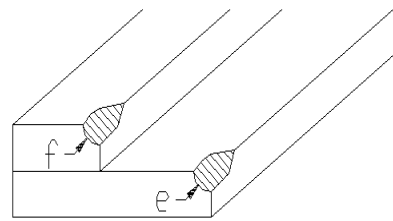
| Items | Contents | Criteria | | | | | | | |
|--------------|---|--|-------------------|-----------------------|-----------------------|-----------------------|-----------------------|-----------------------|--|
| Glass Cracks | <p>Cracks on pads</p>  | a | b | c | Max. 2 cracks allowed | Max. 5 cracks allowed | | | |
| | $\leq 3\text{mm}$ | $\leq W/5$ | $\leq T/2$ | $\leq 2\text{mm}$ | | | $\leq W/5$ | $T/2 < C < T$ | |
| | <p>Cracks on contact side</p>  | a | b | Max. 2 cracks allowed | Max. 5 cracks allowed | | | | |
| | $\leq 3\text{mm}$ | $\leq T/2$ | $\leq 2\text{mm}$ | | | | $T/2 < b < T$ | | |
| | C shall be not reach the seal area | | | | | | | | |
| | <p>Cracks on non-contact side</p>  | a | b | | | | Max. 2 cracks allowed | Max. 5 cracks allowed | |
| | $\leq 3\text{mm}$ | $\leq T/2$ | $\leq 2\text{mm}$ | $T/2 < b < T$ | | | | | |
| | $C \leq 0.5\text{mm}$ | | | | | | | | |
| | $d \leq SW/3$ | | | | | | | | |
| | <p>Corner cracks</p>  | $e < 2.0\text{mm}^2$ $f < 2.0\text{mm}^2$ | | | | | Max. 3 cracks allowed | | |

Appendix B

Inspection items and criteria for display defects

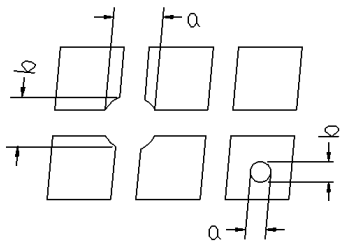
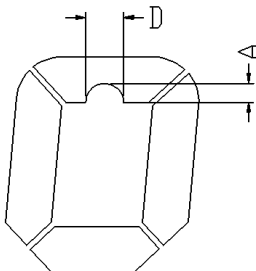
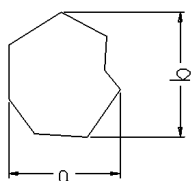
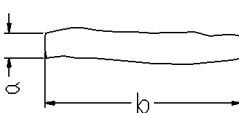
| Items | Contents | Criteria | | |
|---------------------------------------|---|--|--|-----------------------------|
| Open segment or open common | | Not permitted | | |
| Short | | Not permitted | | |
| Wrong viewing angle | | Not permitted | | |
| Contrast ratio uneven | | According to the limit specimen | | |
| Crosstalk | | According to the limit specimen | | |
| Pin holes and cracks in segment (DOT) |  | Not counted | Max.3 dots allowed | Max.3 dots allowed |
| | | $X < 0.1 \text{ mm}$ | $0.1 \text{ mm} \leq X \leq 0.2 \text{ mm}$ | |
| | | $X = (a+b)/2$ | | |
| |  | Not counted | Max.2 dots allowed | |
| $A < 0.1 \text{ mm}$ | | $0.1 \text{ mm} \leq A \leq 0.2 \text{ mm}$ $D < 0.25 \text{ mm}$ | | |
| Black spot (in viewing area) |  | Not counted | Max.3 spots allowed | Max.3 spots (lines) allowed |
| | | $X < 0.1 \text{ mm}$ | $0.1 \text{ mm} \leq X \leq 0.2 \text{ mm}$ | |
| | | $X = (a+b)/2$ | | |
| Black line (in viewing area) |  | Not counted | Max.3 lines allowed | |
| | | $a < 0.02 \text{ mm}$ | $0.02 \text{ mm} \leq a \leq 0.05 \text{ mm}$ $b \leq 0.5 \text{ mm}$ | |

Appendix B

Inspection items and criteria for display defects (continued)

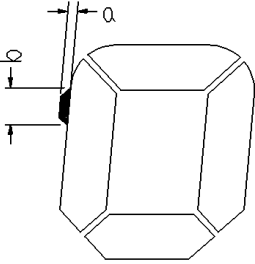
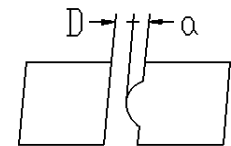
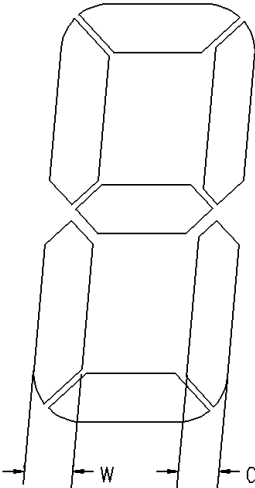
| Items | Content | Criteria | | | |
|---------------------------|---|---|------------------------|-----------------------|--|
| Transformation of segment |  | Not counted | Max. 2 defects allowed | Max.3 defects allowed | |
| | $x < 0.1\text{mm}$ | $0.1\text{mm} \leq x \leq 0.2\text{mm}$ | | | |
| | $x = (a+b)/2$ | | | | |
| |  | Not counted | Max. 1 defects allowed | | |
| | $a < 0.1\text{mm}$ | $0.1\text{mm} \leq a \leq 0.2\text{mm}$ $D > 0$ | | | |
| |  | Max.2 defects allowed $0.8W \leq a \leq 1.2W$ a=measured value of width W=nominal value of width | | | |