

## LOW NOISE 300mA LDO REGULATOR

E20060919

### OUTLINE

The RP102 Series are CMOS-based voltage regulator ICs with high output voltage accuracy, extremely low supply current, low ON-resistance, and high ripple rejection. Each of these ICs consists of a voltage reference unit, an error amplifier, a resistor-net for voltage setting, a current limit circuit and a chip enable circuit.

These ICs perform with low dropout voltage and "chip enable" function. The line transient response and load transient response of the RP102 Series are excellent, thus these ICs are very suitable for the power supply for hand-held communication equipment.

The output voltage of these ICs is fixed with high accuracy. Since the packages for these ICs are SOT23-5, PLP1820-6(Under Development), and WL-CSP-4-P2(Under Development), therefore high density mounting of the ICs on boards is possible.

### FEATURES

- Low Supply Current..... Typ. 50 $\mu$ A
- Standby Mode ..... Typ. 0.1 $\mu$ A
- Low Dropout Voltage ..... Typ. 0.12V ( $I_{OUT}$ =300mA 3.3V Output type)  
..... Typ. 0.14V ( $I_{OUT}$ =300mA 2.5V Output type)
- High Ripple Rejection ..... Typ. 80dB ( $f$ =1kHz 2.5V Output type)
- Low Temperature-Drift Coefficient of Output Voltage..... Typ.  $\pm$ 20ppm/ $^{\circ}$ C
- Excellent Line Regulation..... Typ. 0.02%/V
- High Output Voltage Accuracy.....  $\pm$ 1.0%
- Small Packages ..... WL-CSP-4-P2 (Under development), SOT-23-5,  
PLP1820-6(Under Development)
- Output Voltage..... 1.2V, 1.3V, 1.5V, 1.8V, 2.5V, 2.6V, 2.8V,  
2.85V, 2.9V, 3.0V, 3.3V
- Built-in Fold Back Protection Circuit..... Typ. 50mA (Current at short mode)
- Ceramic capacitors are recommended to be used with this IC.....  $C_{IN}$ = $C_{OUT}$ =1 $\mu$ F or more

### APPLICATIONS

- Power source for portable communication equipment.
- Power source for electrical appliances such as cameras, VCRs and camcorders.
- Power source for battery-powered equipment.

## BLOCK DIAGRAMS

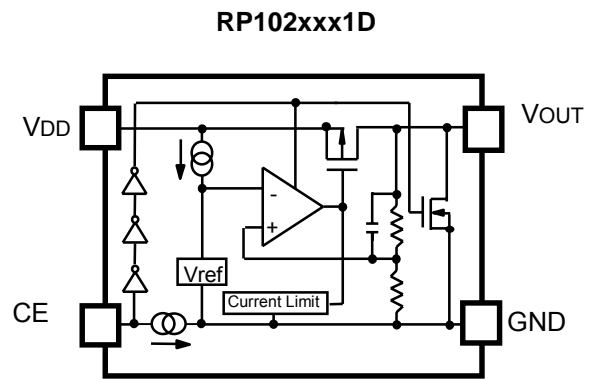
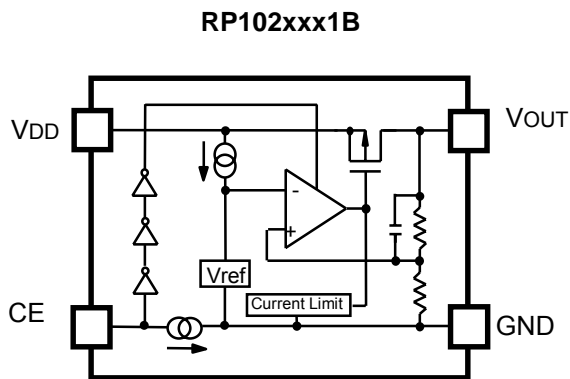

## SELECTION GUIDE

The output voltage, version, and the taping type for the ICs can be selected at the user's request. The selection can be made with designating the part number as shown below;

**RP102xxx1xx-xx**      ←Part Number  
 ↑ ↑    ↑ ↑    ↑  
 a b    c d    e

Code	Contents
a	Designation of Package Type: K: PLP1820-6(Under Development) N: SOT-23-5 Z: WL-CSP4-P2(Under Development)
b	Setting Output Voltage ( $V_{OUT}$ ): 1.2V, 1.3V, 1.5V, 1.8V, 2.5V, 2.6V, 2.8V, 2.85V, 2.9V, 3.0V, 3.3V
c	Designation of Active Type: B: active high type D: active high, with auto discharge
d	Designation of 50mV step of Output Voltage Type: Ex. If $V_{OUT}=2.85$ this digit is described as 5. (RP102X281X5-TR)
e	Designation of Taping Type: Ex. TR (refer to Taping Specifications; TR type is the standard direction.)

**PIN CONFIGURATION**

● **PLP1820-6**

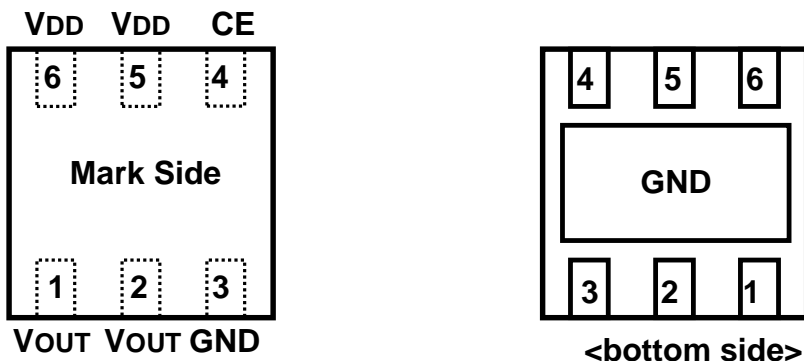

● **SOT-23-5**

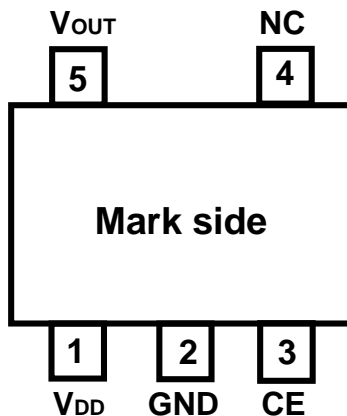

● **WL-CSP4-P2**

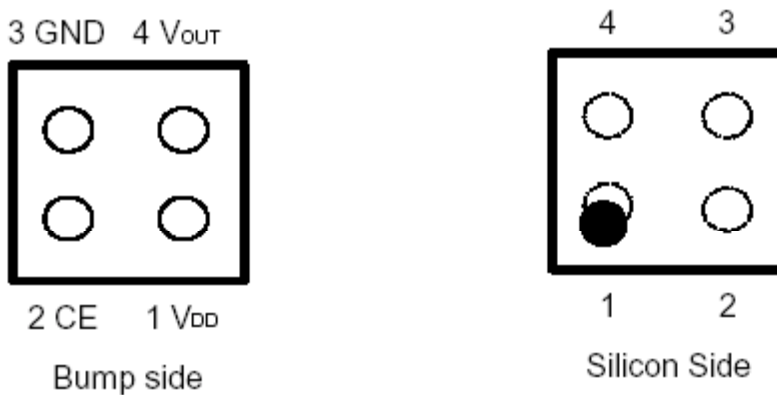

---

**RP102**

---

**PIN DESCRIPTIONS****• RP102K**

Pin No.	Symbol	Description
1	V <sub>OUT</sub>	Output Pin
2	V <sub>OUT</sub>	Output Pin
3	GND	Ground Pin
4	CE	Chip Enable Pin
5	V <sub>DD</sub>	Input Pin
6	V <sub>DD</sub>	Input Pin

**• RP102N**

Pin No.	Symbol	Description
1	V <sub>DD</sub>	Input Pin
2	GND	Ground Pin
3	CE	Chip Enable Pin
4	NC	No Connection
5	V <sub>OUT</sub>	Output Pin

**• RP102Z**

Pin No.	Symbol	Description
1	V <sub>DD</sub>	Input Pin
2	CE	Chip Enable Pin
3	GND	Ground Pin
4	V <sub>OUT</sub>	Output Pin

## ABSOLUTE MAXIMUM RATINGS

Symbol	Item	Rating	Unit
V <sub>DD</sub>	Input Voltage	6.0	V
V <sub>CE</sub>	Input Voltage (CE Pin)	6.0	V
V <sub>OUT</sub>	Output Voltage	-0.3 ~ V <sub>DD</sub> + 0.3	V
I <sub>OUT</sub>	Output Current	400	mA
P <sub>D</sub>	Power Dissipation	PLP1820-6 (Under Development)	880 *
		SOT-23-5 (Free Air)	250
		WLCSP4-P2 (Under Development)	530 *
T <sub>opt</sub>	Operating Temperature Range	-40~85	°C
T <sub>stg</sub>	Storage Temperature Range	-55~125	°C

Measurement Conditions;

Environment: Mounting on Board (Wind velocity=0m/s)

Board Material: Glass cloth epoxy plactic (Double sided)

Board Dimensions: 40mm \* 40mm \* 1.6mm

Copper Ratio: Top side: Approx. 50%, Back side: Approx. 50%

Through-holes: φ0.54mm \* 30pcs(PLP1820-6)

## ELECTRICAL CHARACTERISTICS

- RP102xxx

- $V_{IN}$  = Set  $V_{OUT} + 1V$  for  $V_{OUT}$  options grater than 1.5V.  $V_{IN} = 2.5V$  for  $V_{OUT} \leq 1.5V$ .  $I_{OUT} = 1mA$ ,  $C_{IN} = C_{OUT} = 1\mu F$ , unless otherwise noted.

$T_{opt} = 25^\circ C$

Symbol	Item	Conditions	Min.	Typ.	Max.	Unit
$V_{OUT}$	Output Voltage	(*1)	$V_{OUT} \times 0.99$ (-20mV)		$V_{OUT} \times 1.01$ (20mV)	V
$I_{OUT}$	Output Current		300			mA
$\Delta V_{OUT} / \Delta I_{OUT}$	Load Regulation	$1mA \leq I_{OUT} \leq 150mA$		10	40	mV
$V_{DIF}$	Dropout Voltage	Please see the data sheet below				
$I_{SS}$	Supply Current	$I_{OUT} = 0mA$		50	70	$\mu A$
Istandby	Supply Current (Standby)	$V_{CE} = 0V$		0.1	2.0	$\mu A$
$\Delta V_{OUT} / \Delta V_{IN}$	Line Regulation	Set $V_{OUT} + 0.5V \leq V_{IN} \leq 5.0V$		0.02	0.10	%/V
RR	Ripple Rejection	$f = 1kHz$ , Ripple 0.2Vp-p $V_{IN} = \text{Set } V_{OUT} + 1V$ , $I_{OUT} = 30mA$ (In case that $V_{OUT} \leq 2.0V$ , $V_{IN} = 3V$ )		80		dB
$V_{DD}$	Input Voltage		1.7		5.0	V
$\Delta V_{OUT} / \Delta T$	Output Voltage Temperature Coefficient	$-40^\circ C \leq T_{opt} \leq 85^\circ C$		$\pm 20$		ppm/ $^\circ C$
$I_{LIM}$	Short Current Limit	$V_{OUT} = 0V$		50		mA
$I_{PD}$	CE Pull-down Current		0.05	0.30	0.60	$\mu A$
$V_{CEH}$	CE Input Voltage "H"		1.5			V
$V_{CEL}$	CE Input Voltage "L"				0.3	V
en	Output Noise	$BW = 10Hz$ to $100kHz$ $I_{OUT} = 30mA$		30		$\mu V_{rms}$
Rlow	Nch On Resistance For auto discharge (D version)	$V_{IN} = 4.0V$ $V_{CE} = 0V$		30		$\Omega$

(\*1)  $V_{out} \leq 2.0V \pm 20mV$  accuracy

(\*2) Max. Input Voltage is 5.5V during 500hours

- Dropout Voltage

$V_{OUT}$ (V)	Dropout Voltage					
	Condition	TYP.	MAX.	Condition	TYP.	MAX.
$1.2V \leq V_{OUT} < 1.5V$	$I_{OUT} = 150mA$	145	500	$I_{OUT} = 300mA$	290	500
$1.5V \leq V_{OUT} < 1.7V$		110	160		220	320
$1.7V \leq V_{OUT} < 2.0V$		100	140		200	280
$2.0V \leq V_{OUT} < 2.5V$		85	120		170	240
$2.5V \leq V_{OUT} < 2.8V$		70	100		140	200
$2.8V \leq V_{OUT} \leq 3.3V$		60	95		120	190

## TECHNICAL NOTES

When using these ICs, consider the following points:

### Phase Compensation

In these ICs, phase compensation is made for securing stable operation even if the load current is varied. For this purpose, use a capacitor  $C_{OUT}$  with good frequency characteristics and ESR (Equivalent Series Resistance). (Note: If additional ceramic capacitors are connected with parallel to the output pin with an output capacitor for phase compensation, the operation might be unstable. Because of this, test these ICs with as same external components as ones to be used on the PCB.)

### PCB Layout

Make  $V_{DD}$  and GND lines sufficient. If their impedance is high, noise pickup or unstable operation may result. Connect a capacitor with a capacitance value as much as  $1.0\mu\text{F}$  or more between  $V_{DD}$  and GND pin, and as close as possible to the pins.

Set external components, especially the output capacitor, as close as possible to the ICs, and make wiring as short as possible.

## TYPICAL CHARACTERISTICS

### 1) Output Voltage vs. Output Current ( $C_{in}=1.0\mu\text{F}$ , $C_{out}=1.0\mu\text{F}$ )

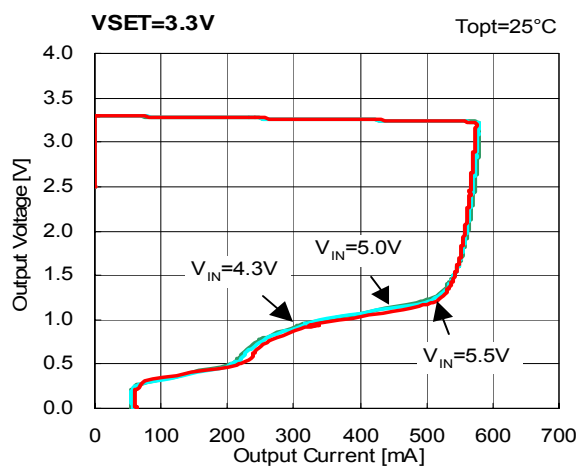
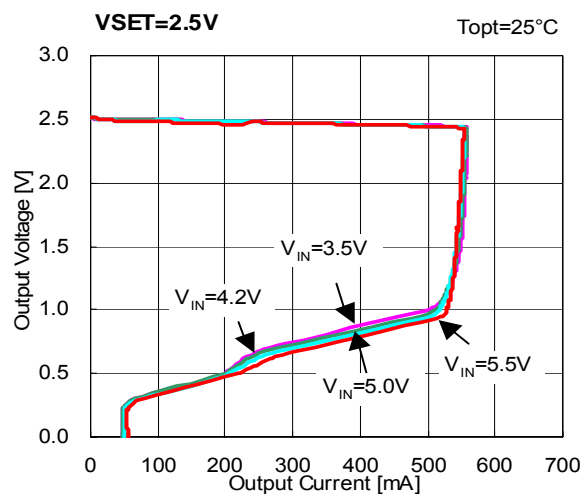
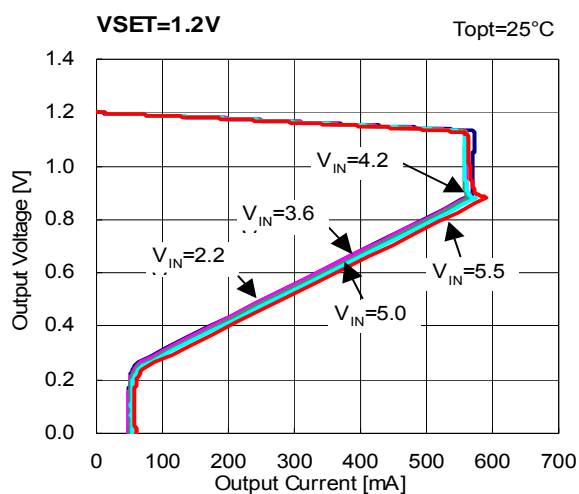

## RP102

### 2) Output Voltage vs. Input Voltage ( $C_{in}=1.0\mu F$ , $C_{out}=1.0\mu F$ )

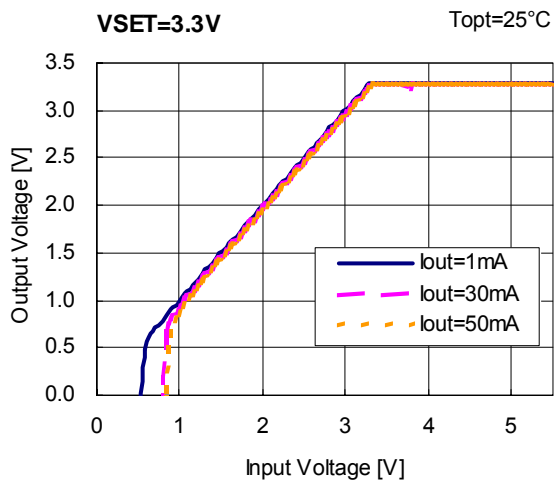
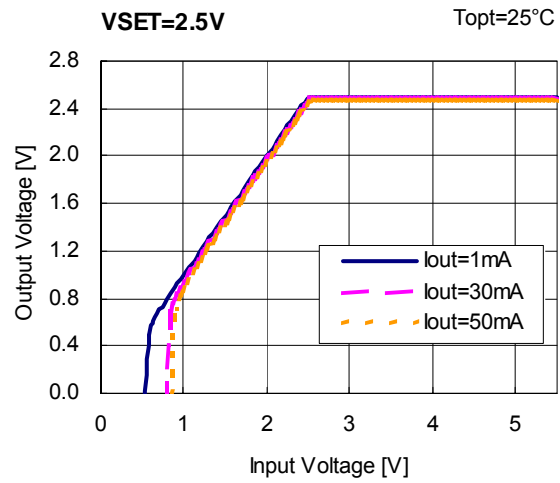
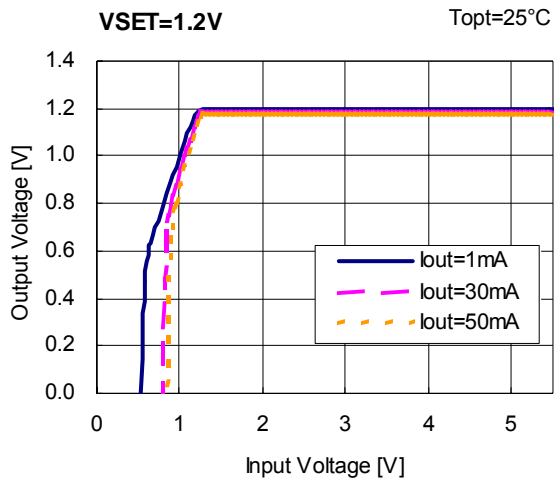

### 3) Supply Current vs. Input Voltage ( $C_{in}=1.0\mu F$ , $C_{out}=1.0\mu F$ )

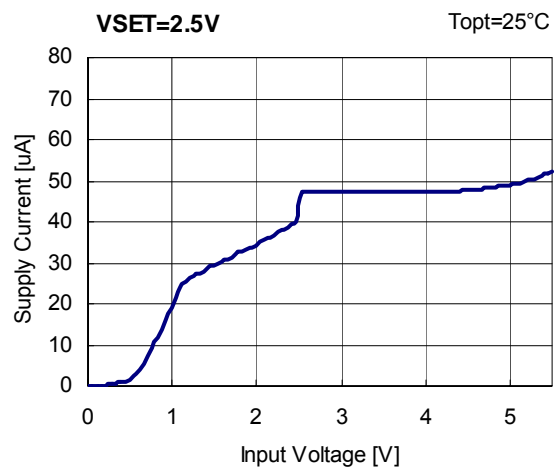
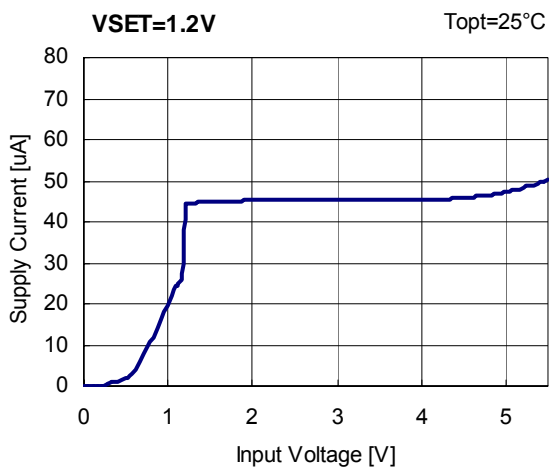



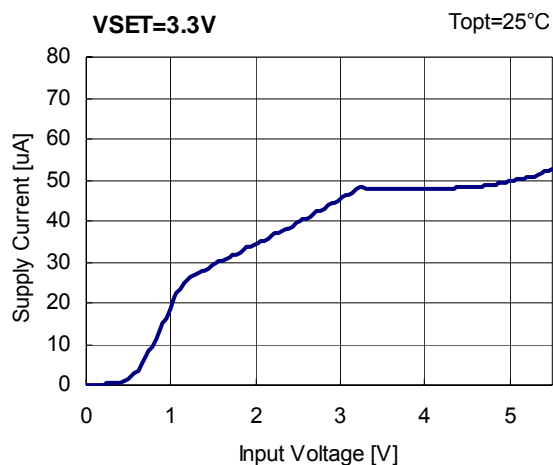

4) Output Voltage vs. Temperature (C<sub>in</sub>=1.0uF , C<sub>out</sub>=1.0uF)

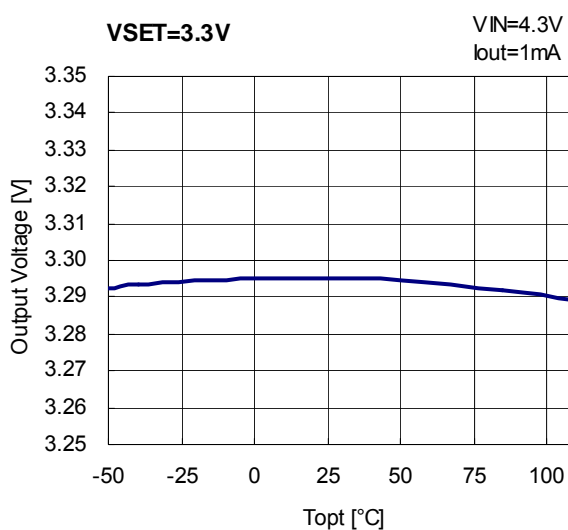
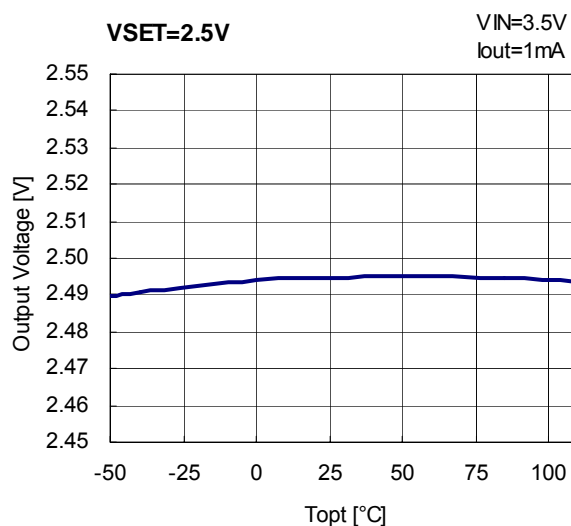
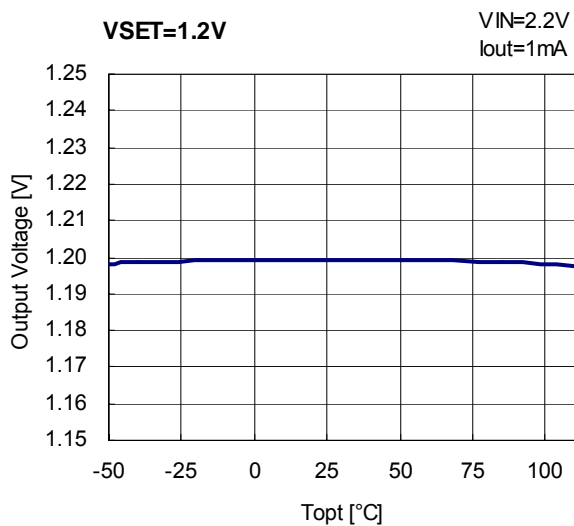

5) Supply Current vs. Temperature (Cin=1.0uF , Cout=1.0uF)

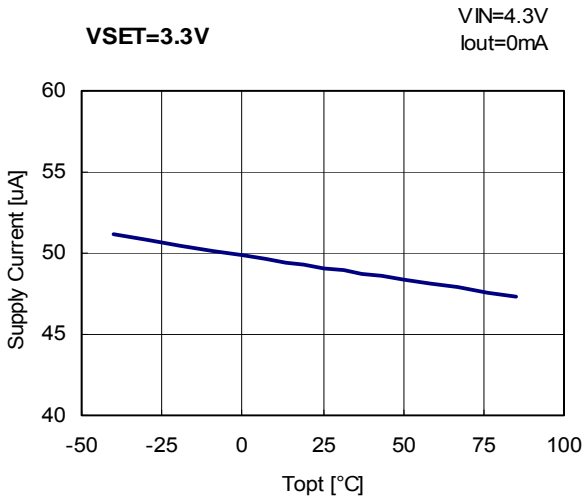
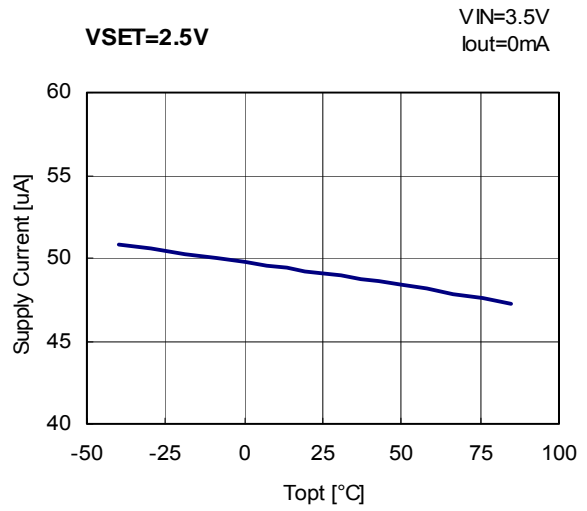
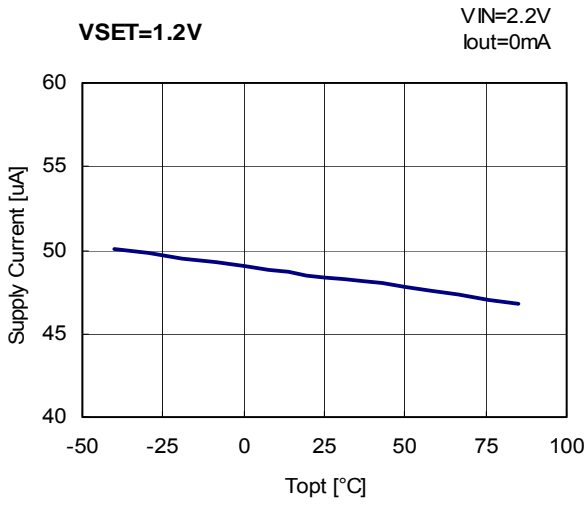

6) Dropout Voltage vs. Output Current (Cin=1.0uF , Cout=1.0uF)

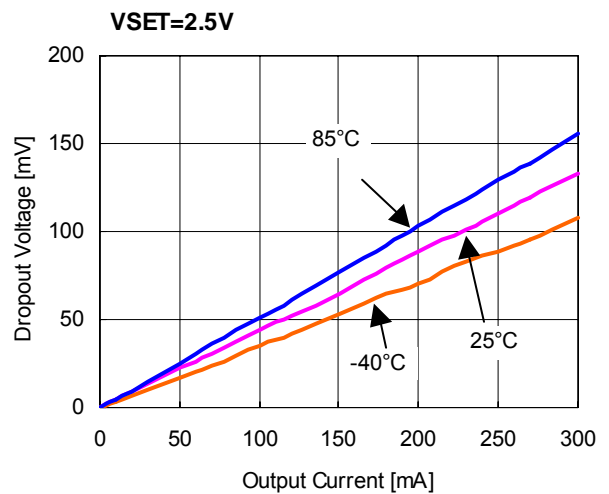
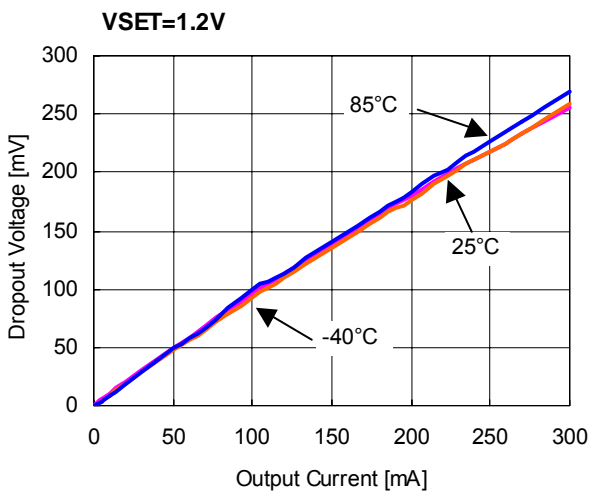

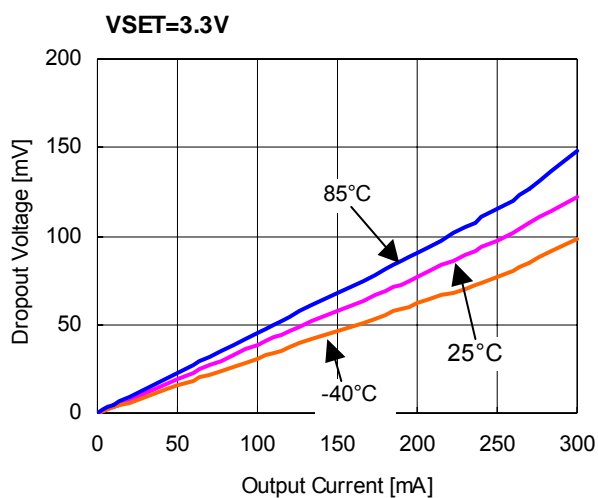

**7) Dropout Voltage vs. VSET (Cin=1.0uF , Cout=1.0uF)**  
Topt=25°C

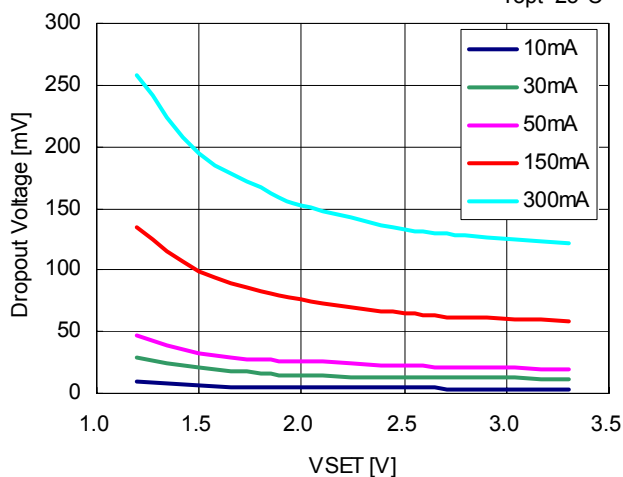

**8) Ripple Rejection vs. Input Bias (Cin=none , Cout=1.0uF)**

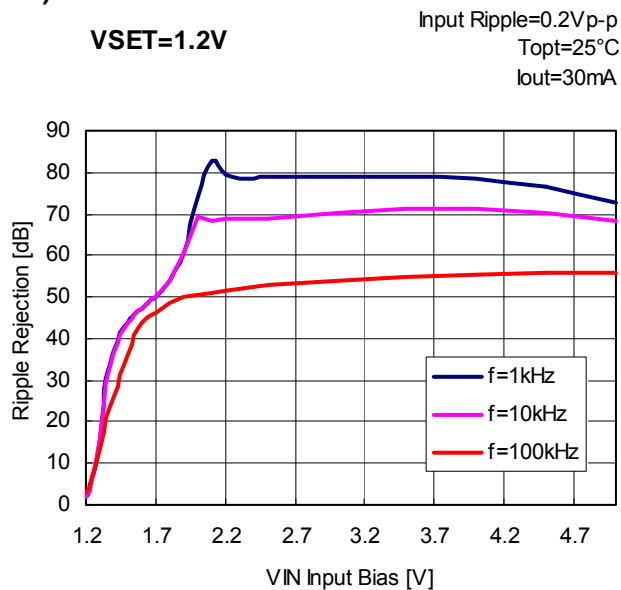
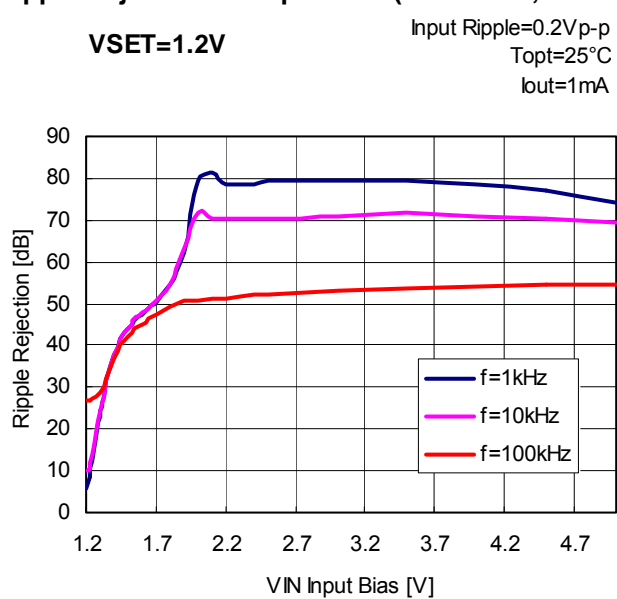

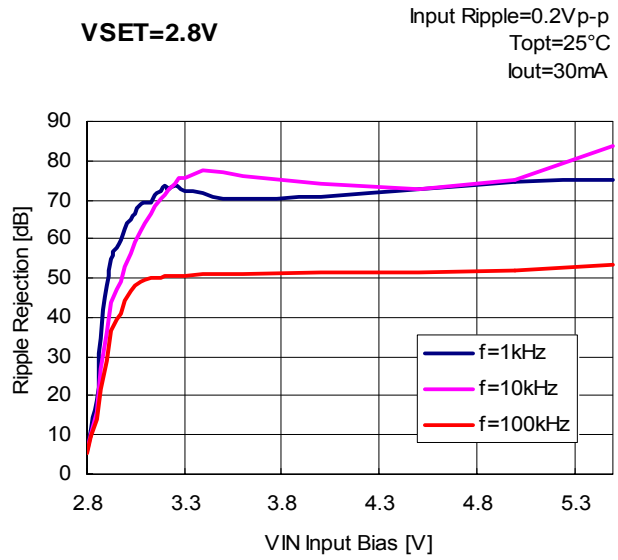
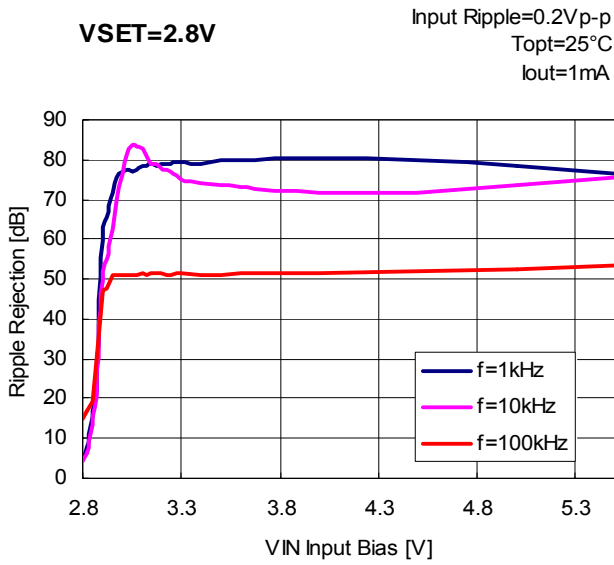

**9) Ripple Rejection vs. Frequency (Cin=none, Cout=1.0uF)**

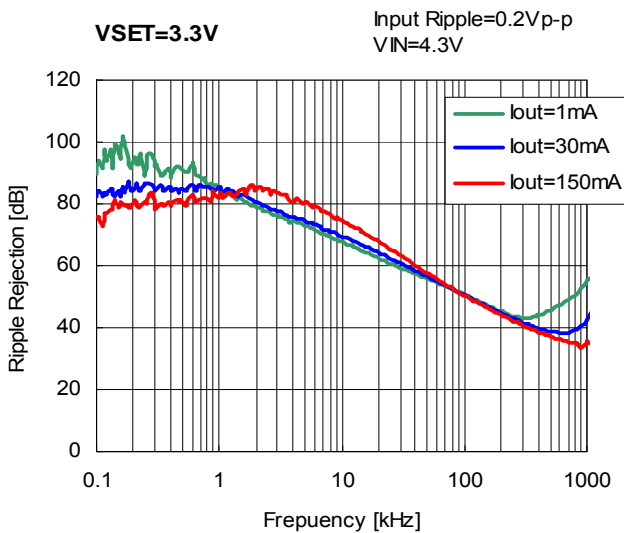
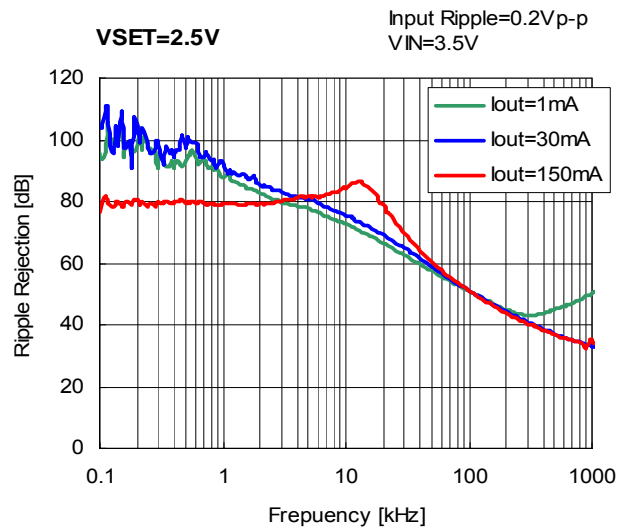
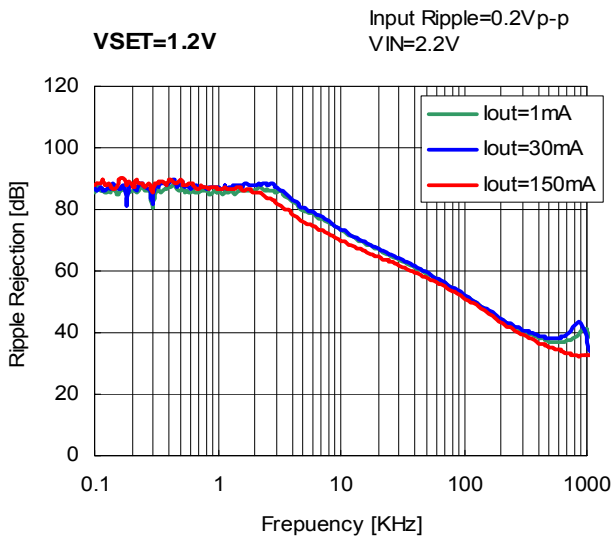

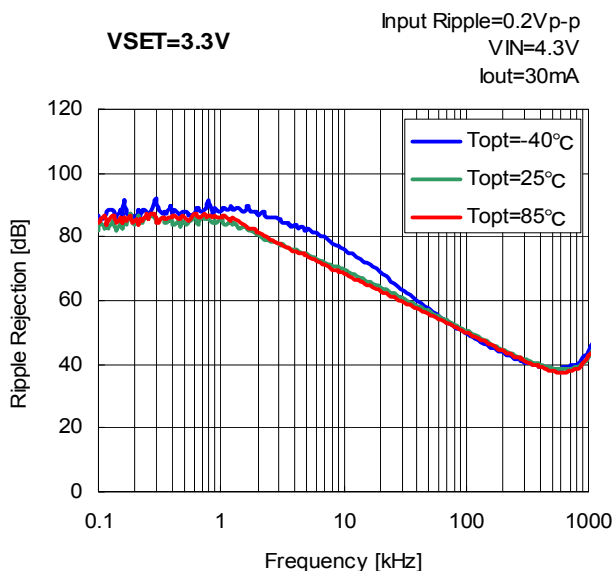
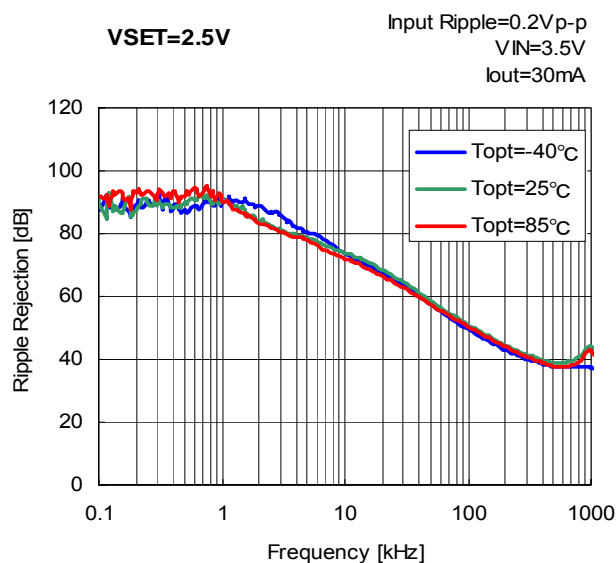
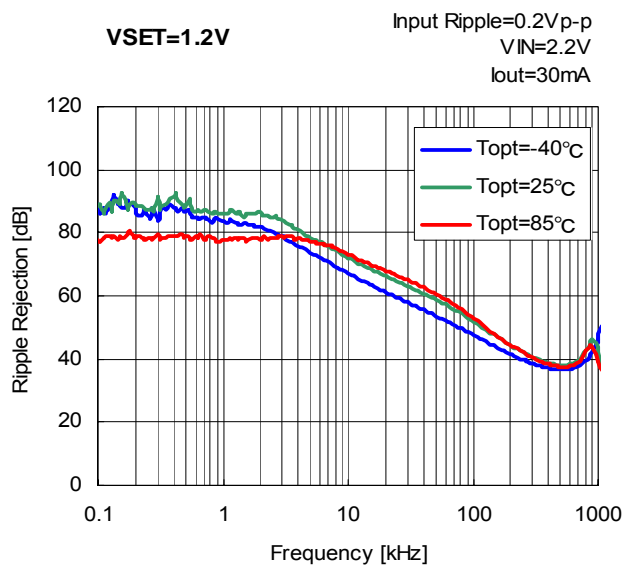

10) Input Transient Response (Cin=none, Cout=1.0uF)

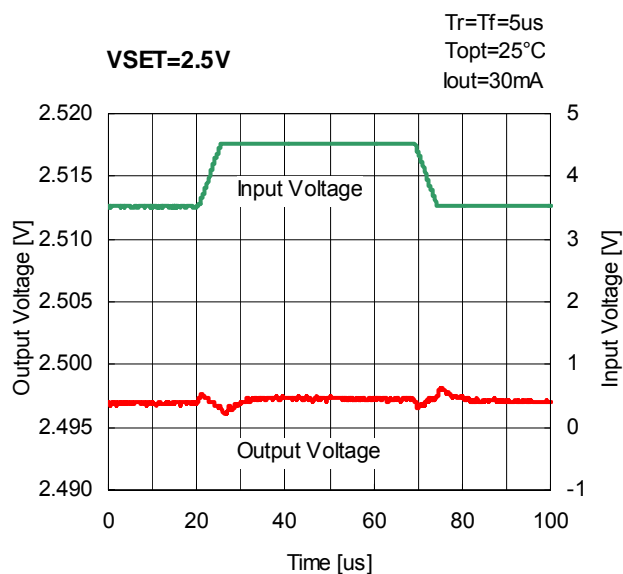
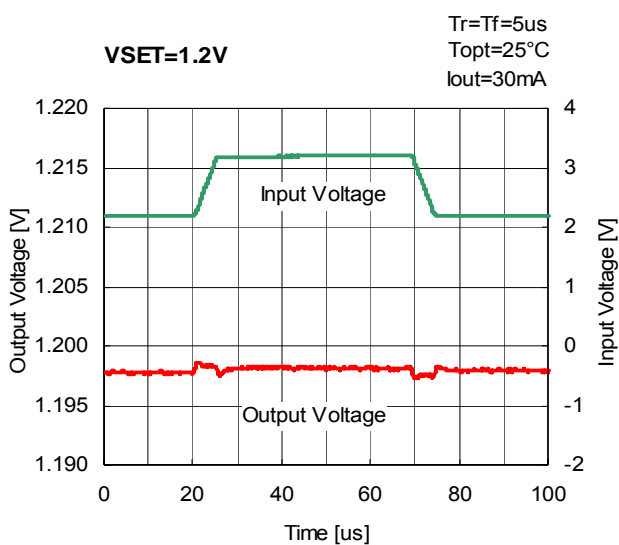

VSET=3.3V

Tr=Tf=5us  
Topt=25°C  
Iout=30mA

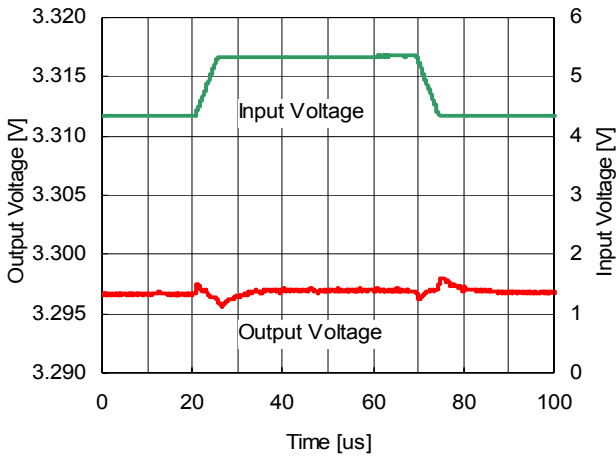

11) Load Transient Response (Cin=1.0uF, Cout=1.0uF)

VSET=1.2V

VIN=2.2V  
Tr=Tf=0.5us  
Topt=25°C

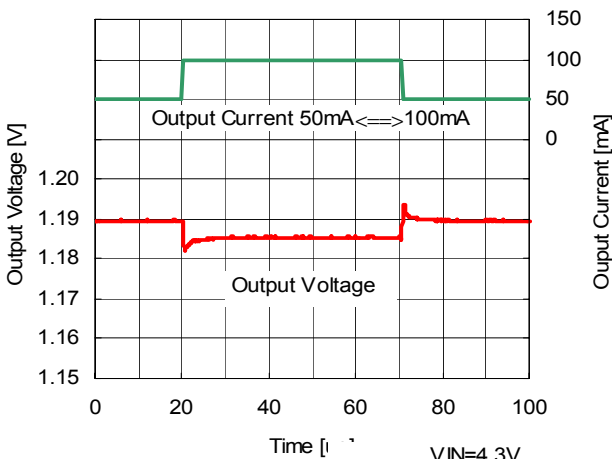

VSET=2.5V

VIN=3.5V  
Tr=Tf=0.5us  
Topt=25°C

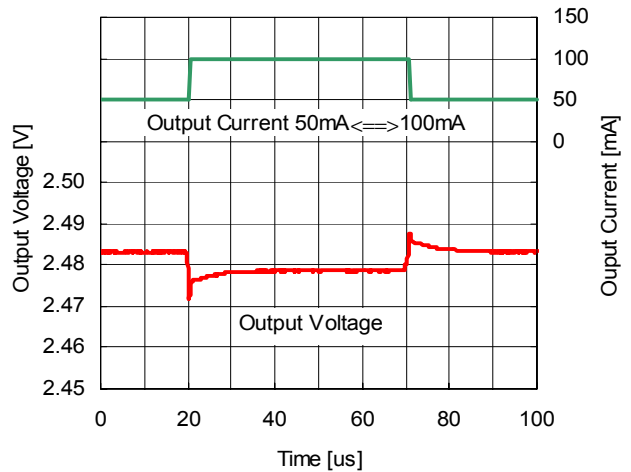

VSET=3.3V

VIN=4.3V  
Tr=Tf=0.5us  
Topt=25°C

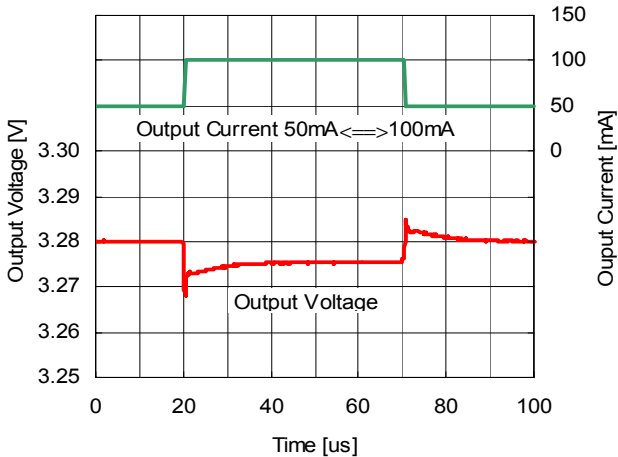

VSET=1.2V

VIN=2.2V  
Tr=Tf=0.5us  
Topt=25°C

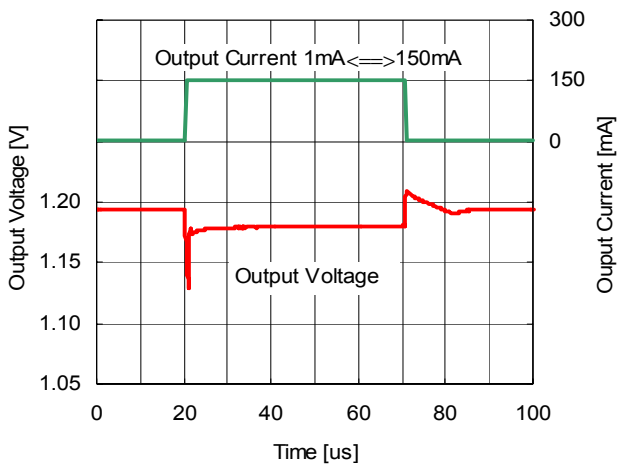

VSET=2.5V

VIN=3.5V  
Tr=Tf=0.5us  
Topt=25°C

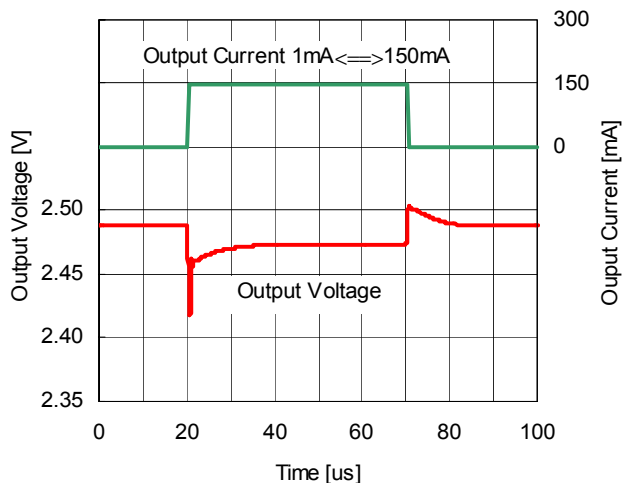

VSET=3.3V

VIN=4.3V  
Tr=Tf=0.5us  
Topt=25°C

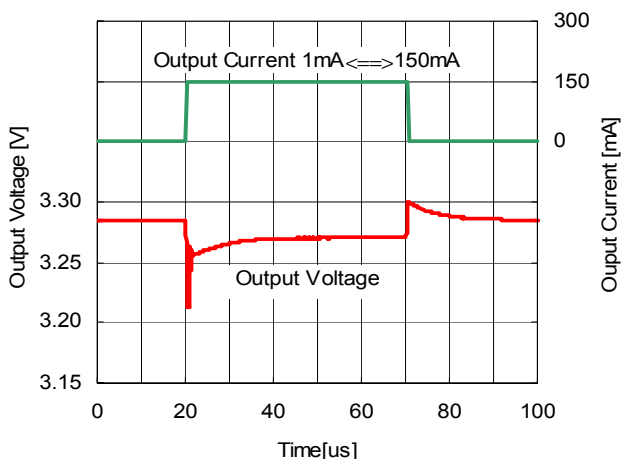

12) Turn On Speed with CE pin (Cin=1.0uF, Cout=1.0uF)

VSET=1.2V

Topt=25°C  
Iout=0mA

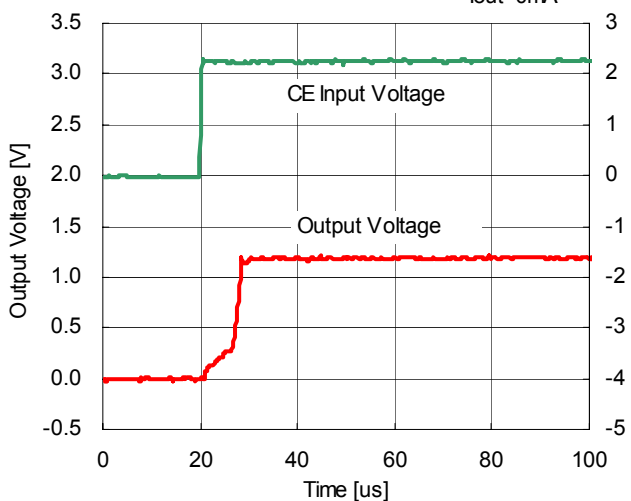

VSET=1.2V

Topt=25°C  
Iout=30mA

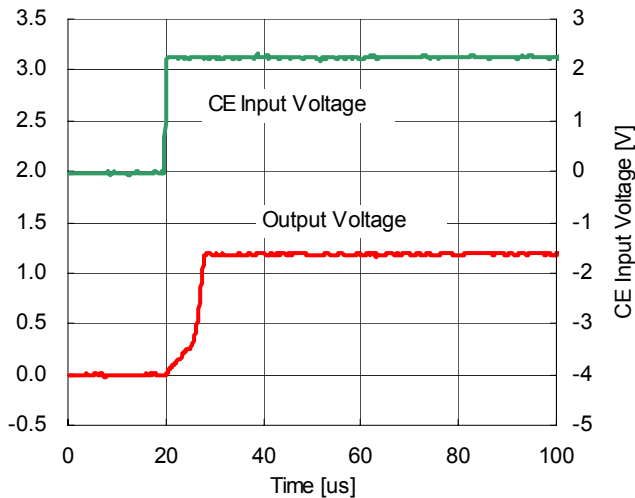

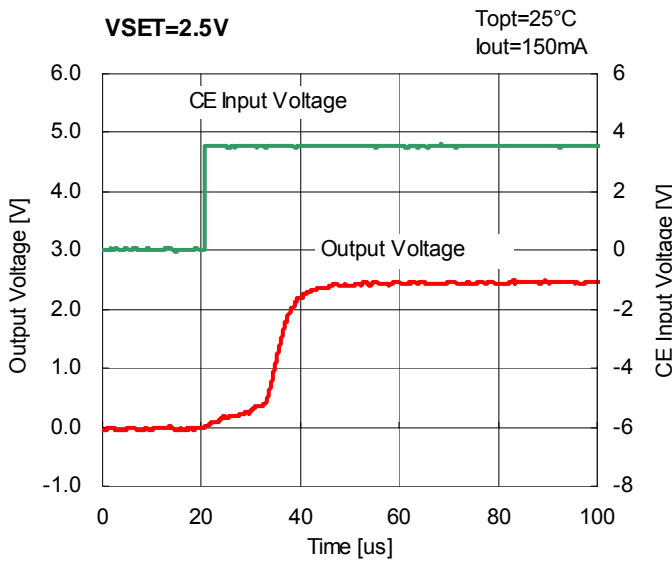
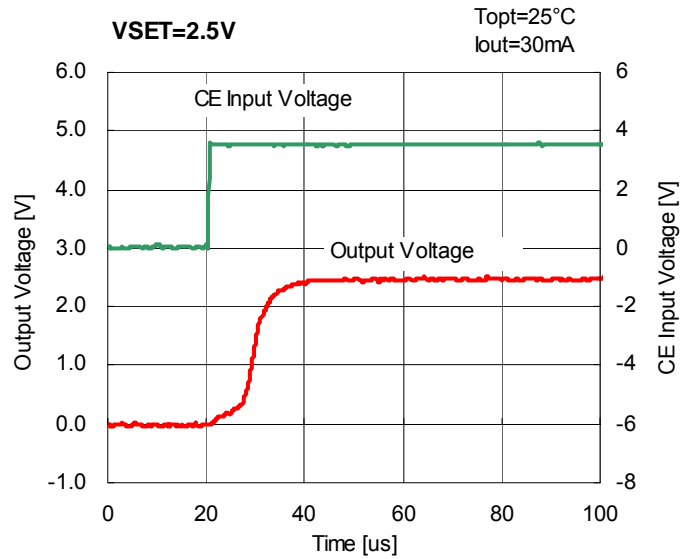
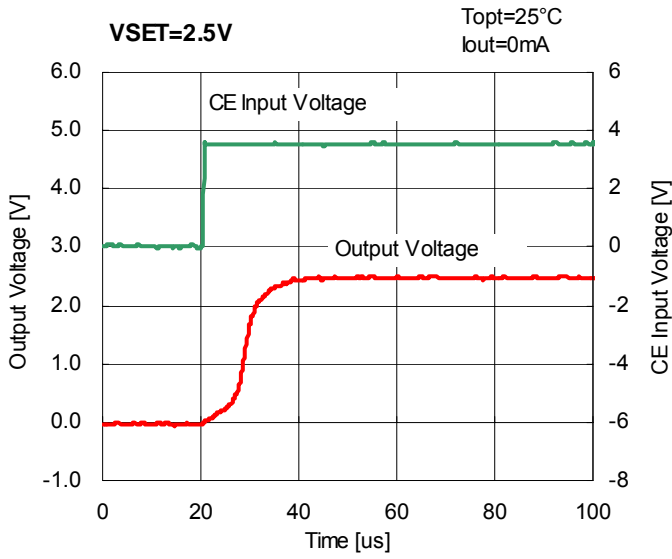
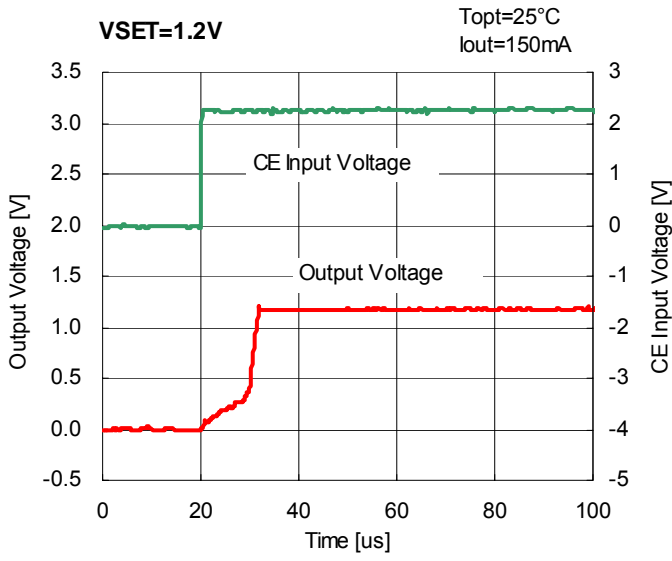



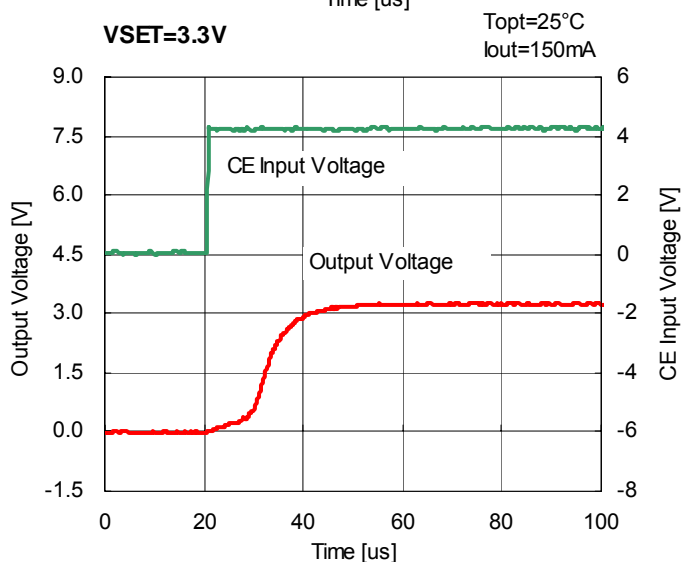
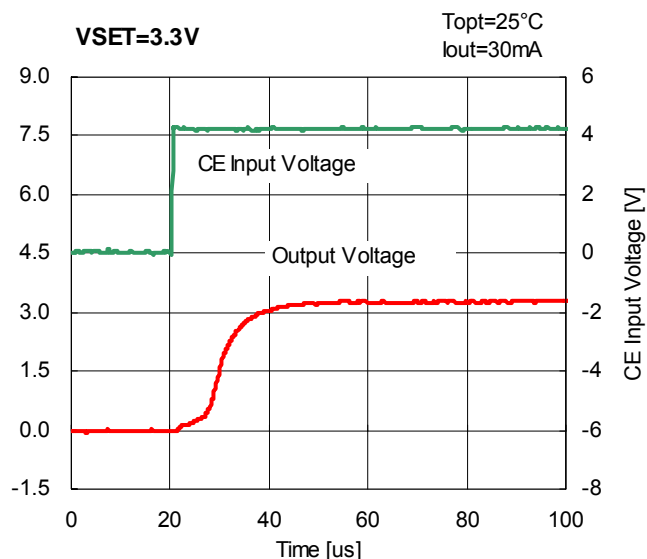
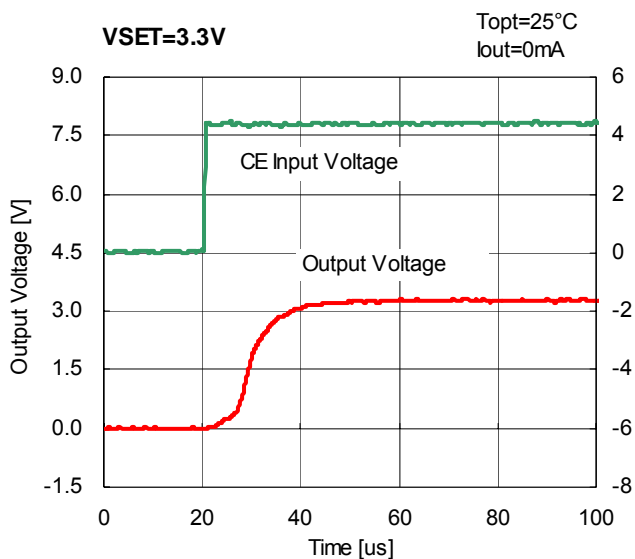

**13) Turn Off Speed with CE pin (D Version) (Cin=1.0uF, Cout=1.0uF)**

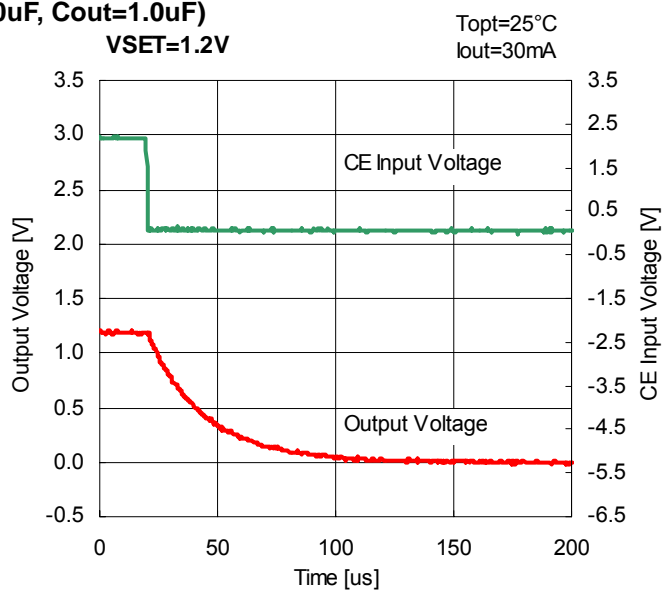
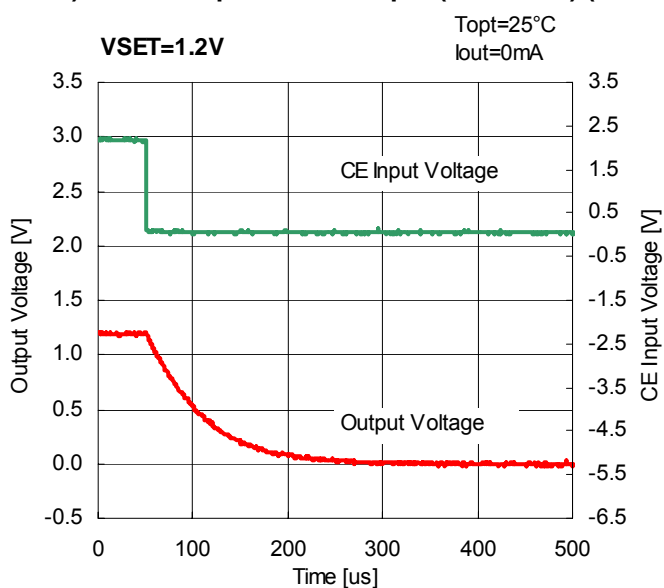

# RP102

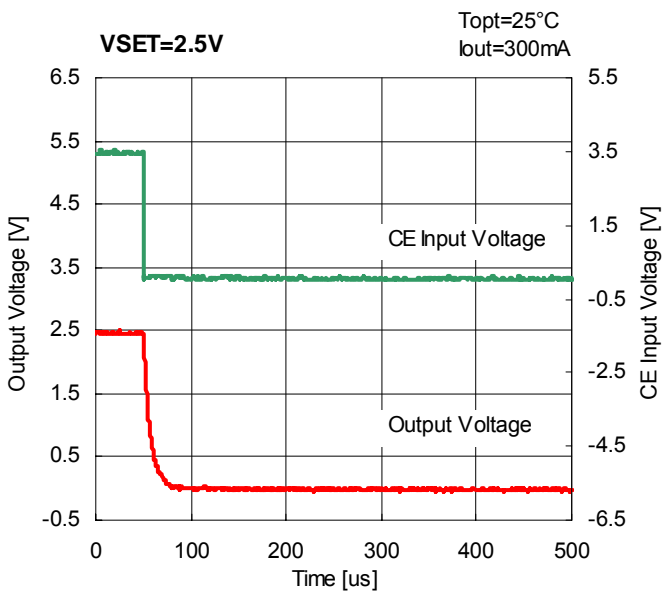
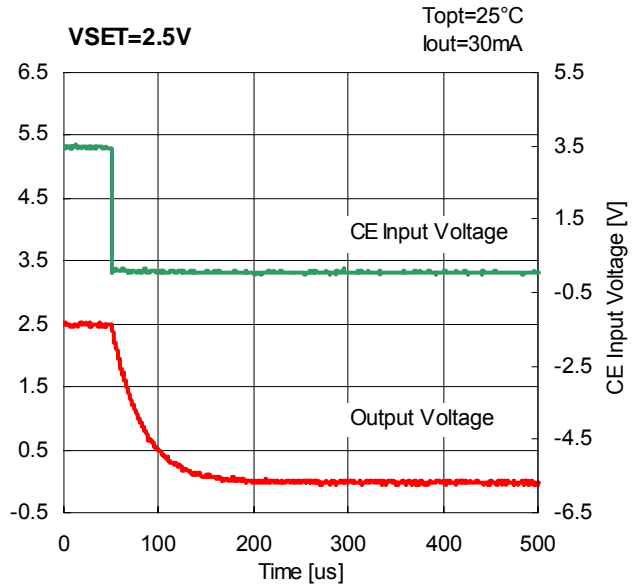
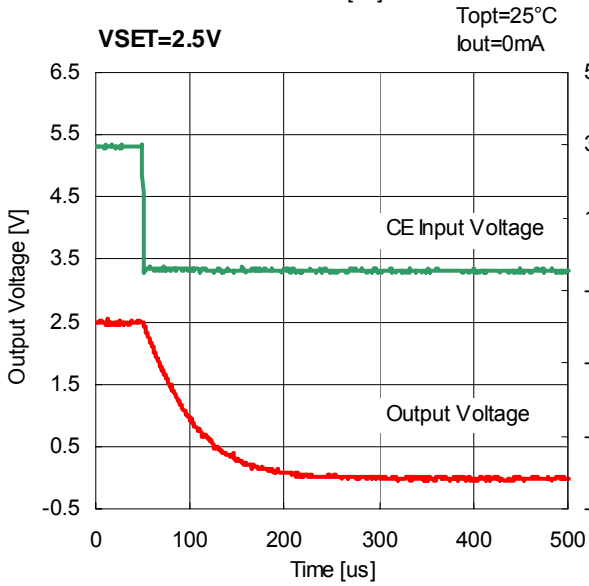
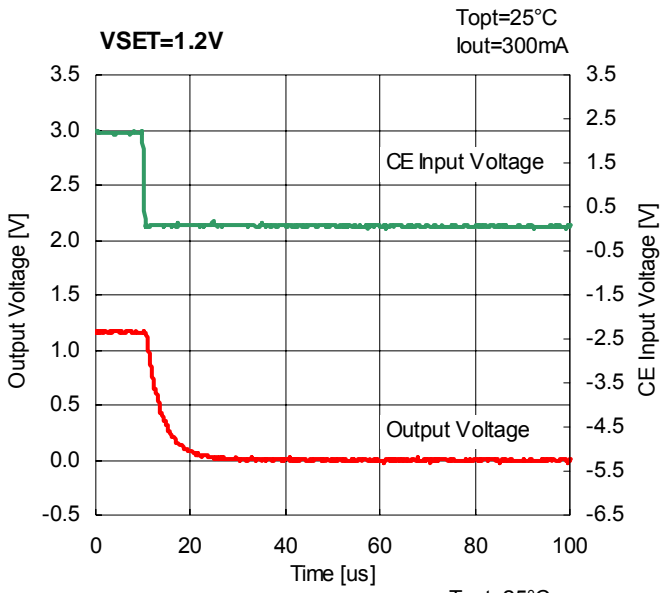

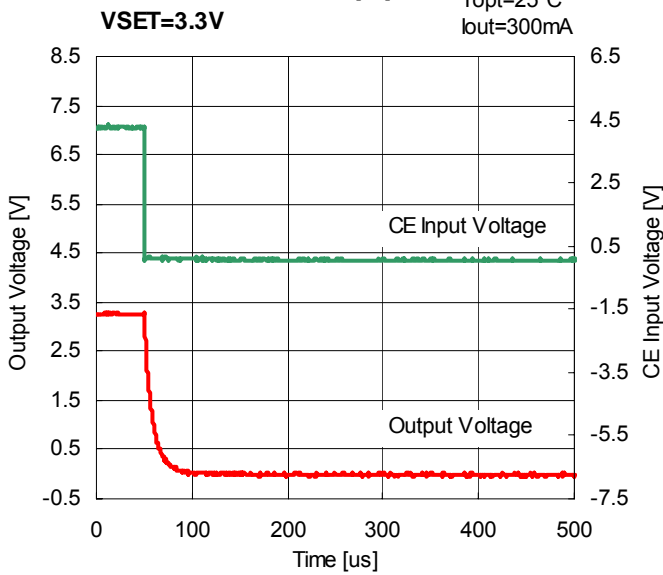
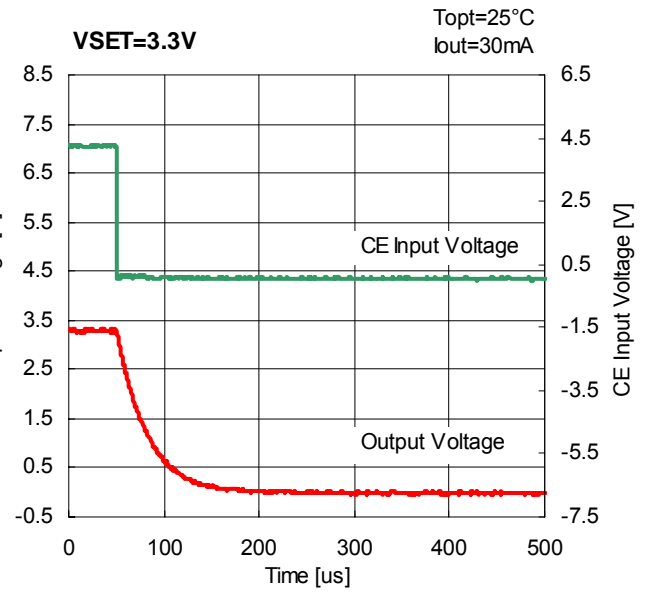
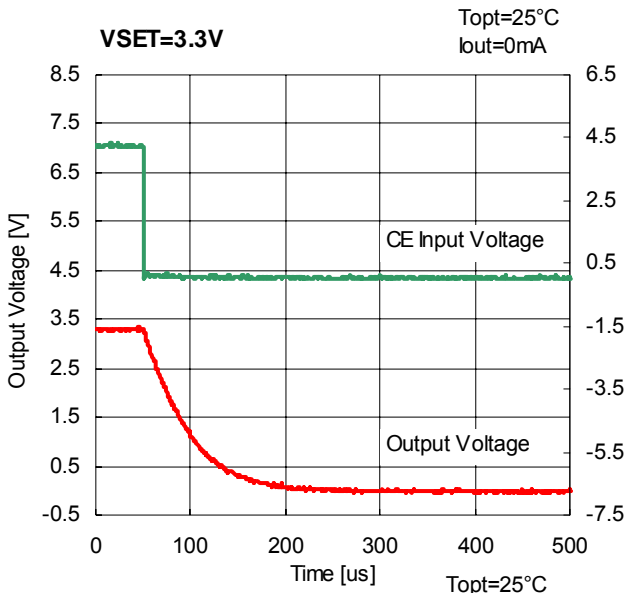

**14) ESR vs Output Current (Frequency Band: 10Hz to 2MHz, Temperature: -40°C to 85°C)**

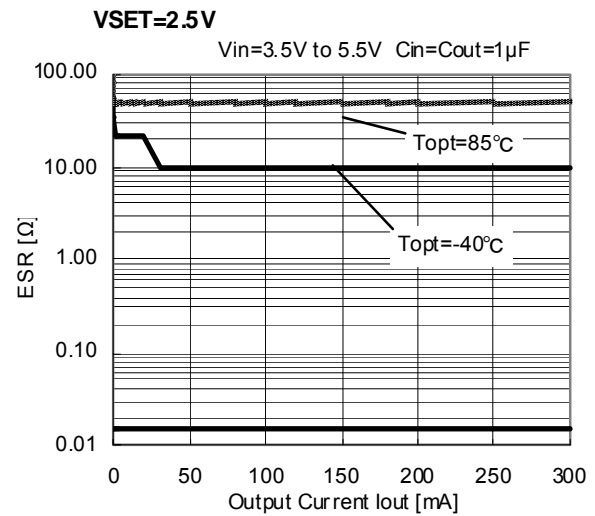
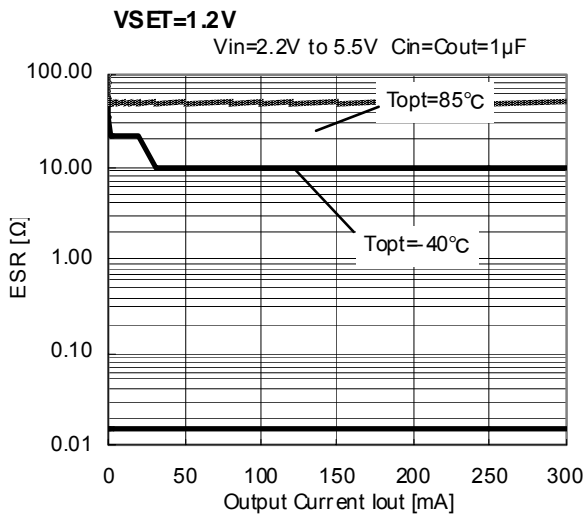

# RP102

